



# UFM2/UBT

UFM2: Clamp-on Ultrasonic Flow Meter

UBT: Clamp-on Ultrasonic Heat Meter

## User Manual



UBT shown

### DWYER INSTRUMENTS, INC.

102 INDIANA HWY 212  
MICHIGAN CITY  
INDIANA 46360  
USA

Phone: 219-879-8000  
Fax: 219-872-9057  
Web: [www.dwyer-inst.com](http://www.dwyer-inst.com)  
Email: [info@dwyer-inst.com](mailto:info@dwyer-inst.com)



---

## CONTENTS

<b>1</b>	<b>INTRODUCTION.....</b>	<b>1</b>
1.1	General Description .....	1
1.2	How Does It Work? .....	2
1.3	Package Contents .....	3
1.4	Display.....	4
1.5	Quick Start Procedure .....	5
<b>2</b>	<b>INSTALLATION.....</b>	<b>6</b>
2.1	Identify Suitable Location .....	6
2.1.1	Additional Considerations for Locating UBT .....	6
2.1.2	Clean the Pipe's Flow Sensor Contact Area .....	7
2.2	Connect Power and Signal Cables .....	7
2.2.1	Power Supply .....	7
2.2.2	Pulse Output Connection.....	8
2.2.3	Current Output (UFM2 only) .....	8
2.2.4	Modbus Connections (if fitted) .....	8
2.2.5	Temperature Sensor Probes (UBT only).....	10
2.3	Switch On.....	11
2.3.1	UFM2 .....	11
2.3.2	UBT .....	12
2.4	Adjust Flow Sensor Separation.....	13
2.5	Apply Gel Pads.....	13
2.6	Clamp Sensor Assembly to Pipe.....	14
2.6.1	Pipe Adaptors .....	14
2.6.2	Attaching to Pipe .....	15
2.7	Remove Sensor-Holding Screws .....	16
2.8	Connect Electronics Module .....	16
2.9	Attach the Temperature Sensors (UBT Only).....	17
2.10	Normal Operation .....	18
2.10.1	UFM2 .....	18
2.10.2	UBT .....	18
2.10.3	Troubleshooting the Flow Reading .....	19
2.11	Clip Electronics Module to Sensor Assembly .....	19
<b>3</b>	<b>MENUS.....</b>	<b>20</b>
3.1	Accessing the Menus.....	20
3.2	Setup Menu .....	21
3.3	Modbus Menu.....	22

3.4	Current Output Menu (UFM2 only).....	23
3.5	Pulse Output Menu.....	24
3.6	Calibration Menu.....	25
3.7	Volume Totals Menu.....	26
3.8	Diagnostics Menu.....	27
<b>4</b>	<b>OUTPUTS.....</b>	<b>28</b>
4.1	Pulse Output.....	28
4.1.1	Volumetric Pulse.....	28
4.1.2	Frequency Mode.....	29
4.1.3	Energy Pulse (UBT only).....	29
4.1.4	Flow Alarm - Low Flow.....	29
4.1.5	Flow Alarm – Signal Loss.....	29
4.2	4-20 mA Current Output (UFM2 only, if fitted).....	29
4.3	Modbus (if fitted).....	30
<b>5</b>	<b>RELOCATING THE UNIT.....</b>	<b>33</b>
<b>6</b>	<b>APPENDIX.....</b>	<b>34</b>
6.1	Specification.....	34
6.2	Default values.....	36
6.3	Limitations with Water-Glycol Mixtures.....	36
6.4	Positioning.....	36
6.5	Error and Warning Messages.....	38
6.5.1	Error Messages.....	38
6.5.2	Example Error Messages.....	38
6.5.3	Modbus Error Messages (if Modbus fitted).....	39
6.5.4	Flow Errors.....	39
6.5.5	Flow Warnings.....	39
6.5.6	Data Entry Errors.....	40

# 1 INTRODUCTION

## 1.1 General Description

This manual describes the installation and use of the UFM2 flow meter and UBT energy meter:

- **UFM2** is an ultrasonic clamp-on flow meter for measuring flow rate and total flow with a volume pulse output and optional Modbus or 4-20 mA flow proportional output. It can be used as a standalone meter or as part of an integral management system.
- **UBT** is an ultrasonic clamp-on thermal, heat/energy meter. It uses ultrasound to measure flow rate and is also equipped with PT100 temperature sensors to measure flow and return temperatures. The energy meter displays energy rate and totalised energy with pulse output and communication options, so it can be used as a standalone meter or as an integral part of Automatic Monitoring & Targeting (aM&T) or a Building Energy Management System (BEMS).

The electronics and sensor housings form an integral unit which attaches to the pipe using the supplied hose clips. Power to the unit is provided by an external 12-24 VDC / 24 VAC power supply (7 W / 7 VA minimum). The unit operates on steel, stainless steel, copper and plastic pipes with internal diameter in the range 0.8" (20 mm) to 6.5" (165 mm) depending on the product purchased. The models can also be supplied with Modbus digital communication options.

Typical applications:

### UFM2

Hot water metering and flow measurement  
Flow measurement for heat metering  
Chilled water metering and flow measurement  
Potable water metering and flow measurement  
Process water metering and flow measurement  
Ultra-pure water metering and flow measurement.

### UBT

Hot water metering and flow measurement  
Flow measurement for Energy Metering  
Chilled water metering and flow measurement

### NOTE:

The UBT default configuration is:

- **Instrument Type:** Heating
- **Installation Side:** Return
- **Fluid:** Water

*Return* refers to the location of the flow measurement relative to flow circuit.

## 1.2 How Does It Work?

The UFM2 and UBT meters use a cross correlation transit time algorithm to provide accurate flow measurements.

An ultrasonic beam of a given frequency is generated by applying a repetitive voltage pulse to the transducer crystals. This transmission goes first from the downstream (blue) transducer to the upstream transducer (red) as shown in the upper half of Figure 1. The transmission is then made in the reverse direction, being sent from the upstream transducer (red) to the downstream transducer (blue) as shown in the lower half of Figure 1. The speed at which the ultrasound is transmitted through the liquid is accelerated slightly by the velocity of the liquid through the pipe. The subsequent time difference  $T1 - T2$  is directly proportional to the liquid flow velocity.

With the UBT, two temperature sensors measure the difference in temperature between the supply and return of the flow system being monitored. The temperature difference, in combination with the volume of water that has flowed through the system, is then used to calculate the energy transferred to or from the water.

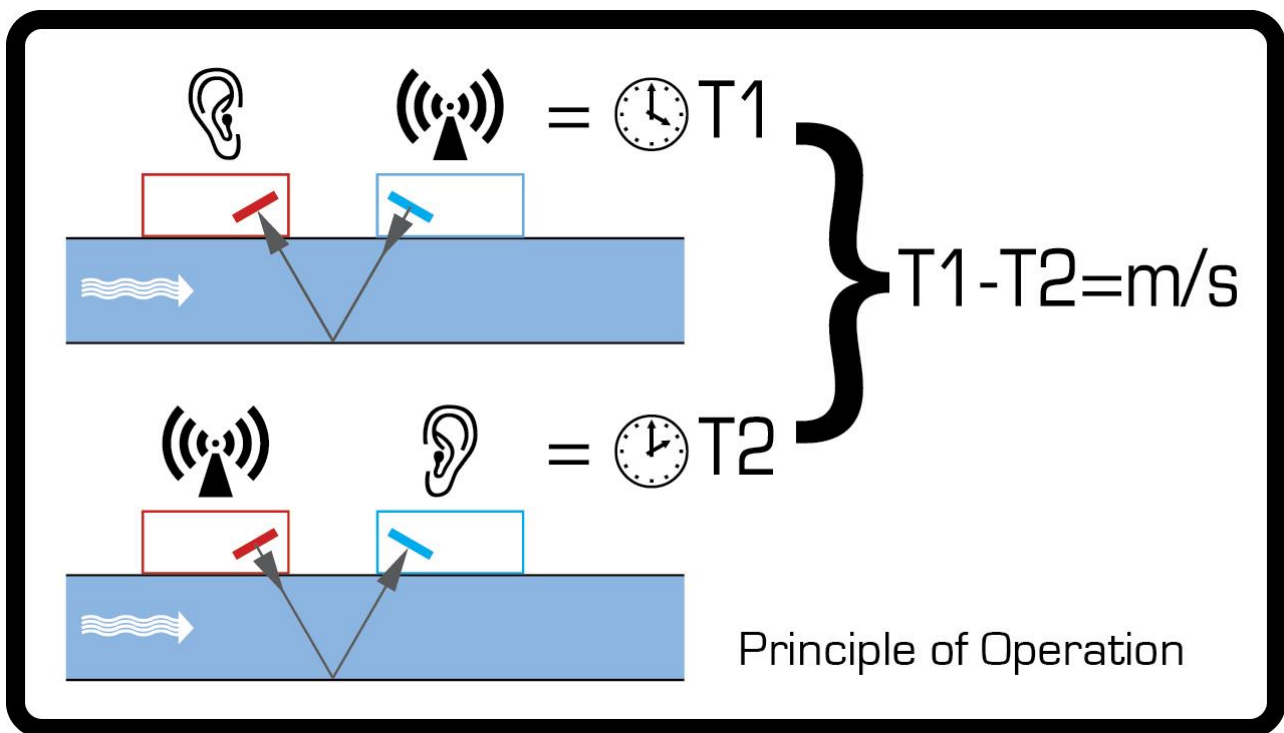

Figure 1 Principle of Transit-Time operation

### 1.3 Package Contents

The unit consists of two parts:

1. **Sensor Assembly**  
Incorporating guide rails and two transducers for flow measurement.
2. **Electronics Module**  
Consisting of the keypad and display, power, signal and Modbus connections. The Electronics Module clips onto the Sensor Assembly.

In addition, the kit contains:

3. Adhesive gel pads (4)
4. 2-part adaptors for fixing sensor assembly to pipes with an OD less than 2 ½" (75 mm) (2).
5. *UBT only*: Non-releasable stainless cable ties for temperature sensors (2)
6. Quick release clamps for use with pipes with an OD of ¾ - 2 ½" (25-75 mm) (2)
7. Quick release clamps for use with pipes with an OD of 2 – 5" (63-140 mm) (2)
8. *UBT only*: PT100 temperature sensors with cable (9.8' (3 m)) (2)
9. Modbus cable (optional)

The kit also contains a copy of this manual.

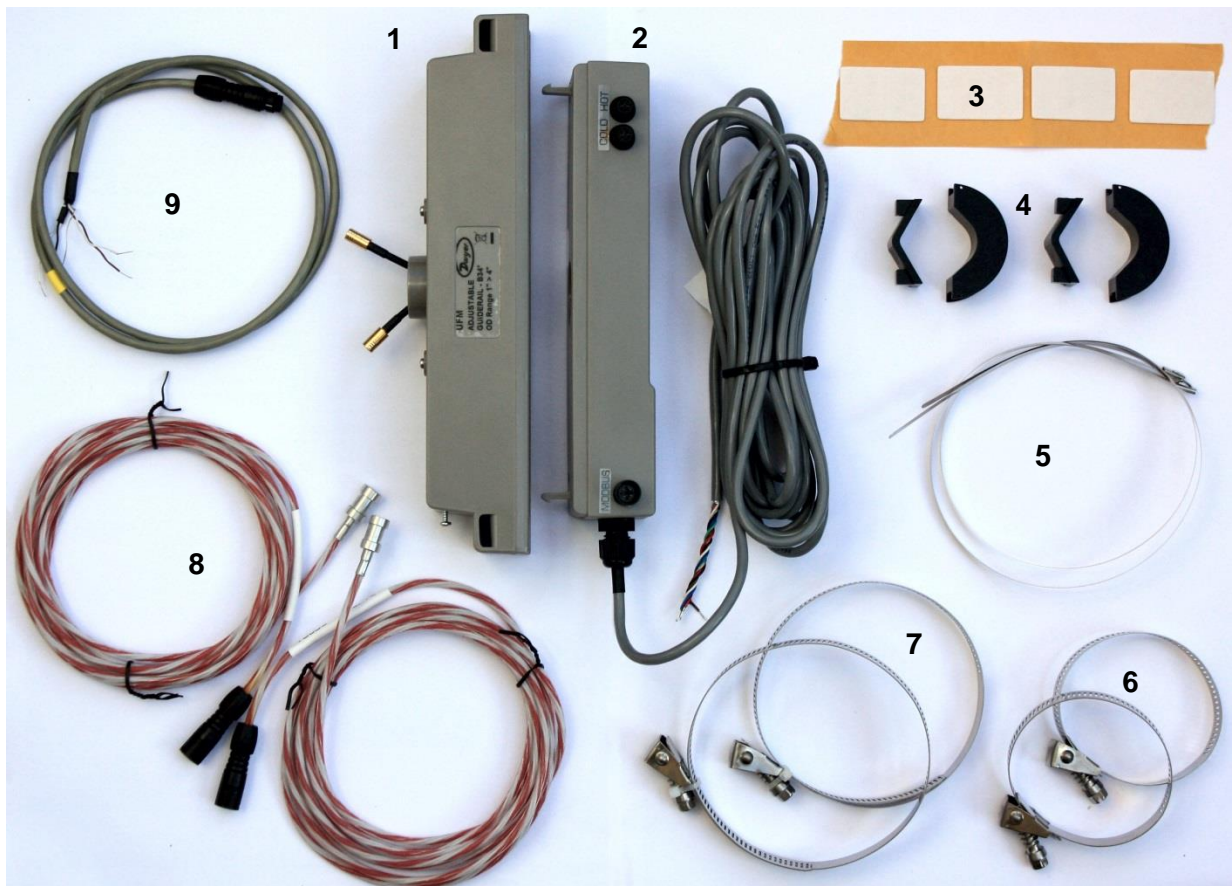

Figure 2 Package Contents



## 1.4 Display

The meter display comprises:

- One 2-line x 16 character LCD with backlight
- Four tactile key switches
- Two LEDs

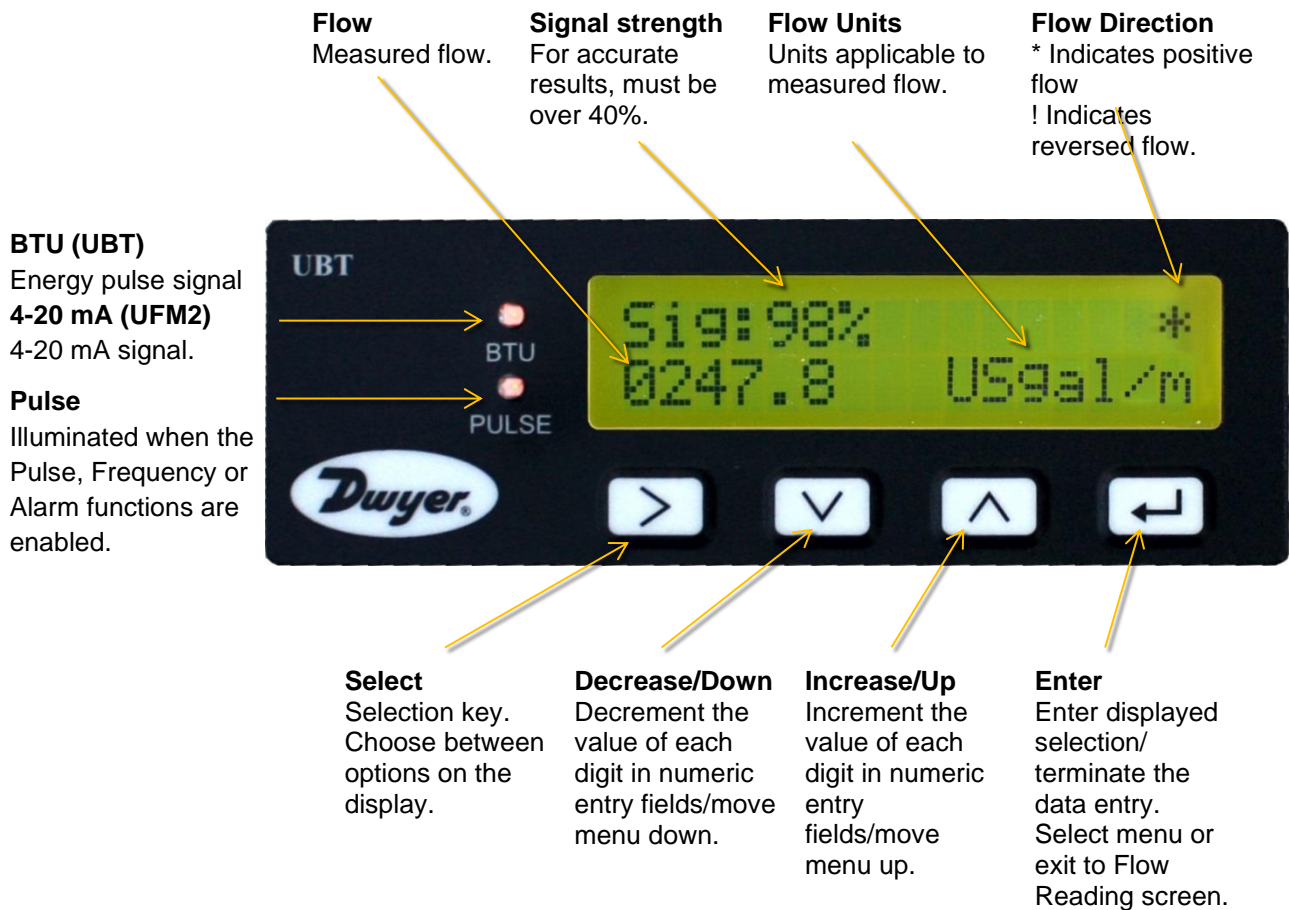



Figure 3 Display (UBT model shown)



## 1.5 Quick Start Procedure

The following procedure summarises the steps required to set up the meter. Please refer to the referenced sections for full details.

1. Identify a suitable location for the meter on a straight length of pipe clear of bends and valves or similar obstructions (See pages 6 and 36).
  2. Electronics Module:
    - a. Connect to a 12 – 24 VDC or 24 VAC power supply (7 W / 7 V minimum per instrument) using the Blue and Brown wires. (See page 7).
    - b. Switch on and program to determine the correct separation code. (see page 11).
  3. Sensor Assembly:
    - a. Loosen but do not remove the two sensor-holding screws to lower the flow sensors so they can slide along the Sensor Assembly's internal guide rail (see page 13).
    - b. Set the flow sensors to the correct separation (see page 13).
    - c. Tighten the sensor-holding screws.
    - d. Apply the gel pads to the sensors (see page 13).
    - e. Mount the Sensor Assembly onto the pipe using the supplied hose clips (see page 15).  
If the pipe has an OD less than 2 ½" (75 mm), use the adaptors provided (see page 14).
    - f. Remove the sensor-holding screws (see page 16).
  4. Connect the two wires from the Sensor Assembly to the Electronics Module (see page 16).
-  **DO NOT CLIP THE ELECTRONICS MODULE ONTO THE SENSOR ASSEMBLY AT THIS STAGE. THE ELECTRONICS MODULE CAN BE FULLY CLIPPED DOWN LATER ONCE ALL MEASUREMENTS HAVE BEEN CHECKED.**
5. *UBT only*: Plug in the temperature sensors to the Electronics Module (see page 17) and attach the PT100 sensors to the flow and return pipes (see Section 2.1.1, page 6).
  6. Check that flow readings can be obtained (see page 18).
  7. Clip the Electronics Module to the Sensor Assembly and tighten the side screw to complete assembly (see page 19).

To use the Pulse Output features, see page 28.

To use the 4-20 mA Output, see page 29 (*UFM2 only*).

To use the Modbus interface, see page 30. The address, data rate, and configuration of the instrument must be set using the Modbus Menu (see page 22). The default address is 1, the default data rate is 38400 baud, and the default Comms configuration is 8-None-2.

## 2 INSTALLATION

### 2.1 Identify Suitable Location

We recommend a location where there is a straight length of pipe with no bends, constrictions or obstructions within at least 10 times the pipe diameter upstream, and 5 times the pipe diameter downstream.

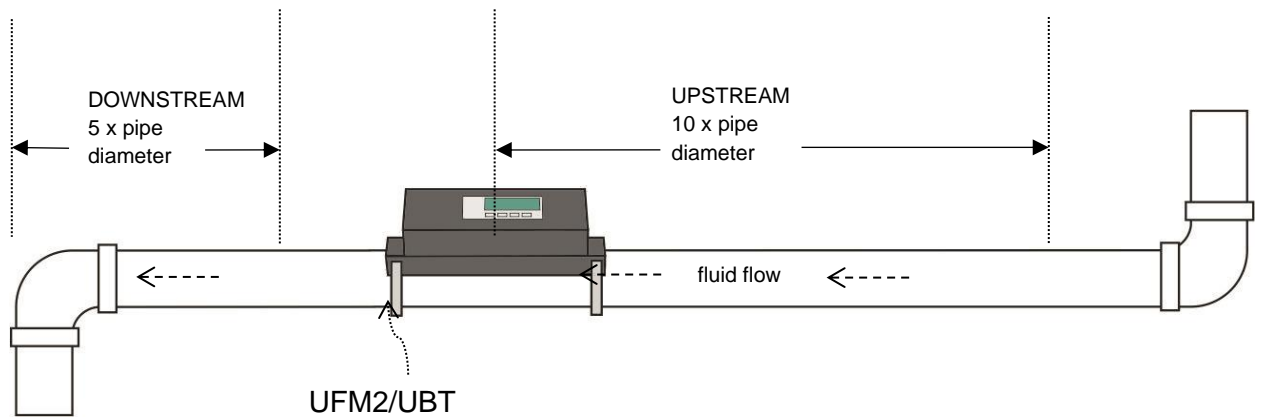

Figure 4 Identifying a suitable location



**IMPORTANT: DO NOT EXPECT TO OBTAIN ACCURATE RESULTS IF THE UNIT IS POSITIONED CLOSE TO ANY OBSTRUCTION THAT DISTORTS THE UNIFORMITY OF THE FLUID FLOW PROFILE (SEE PAGE 36). DWYER INSTRUMENTS INC. ACCEPTS NO RESPONSIBILITY OR LIABILITY IF PRODUCT HAS NOT BEEN INSTALLED IN ACCORDANCE WITH THESE INSTRUCTIONS.**

#### 2.1.1 Additional Considerations for Locating UBT

For optimum reliability on boiler applications, the flow measurement needs to be made on the cold side of the system. For optimum reliability in chiller applications, the flow measurement needs to be made on the warmer side of the system.

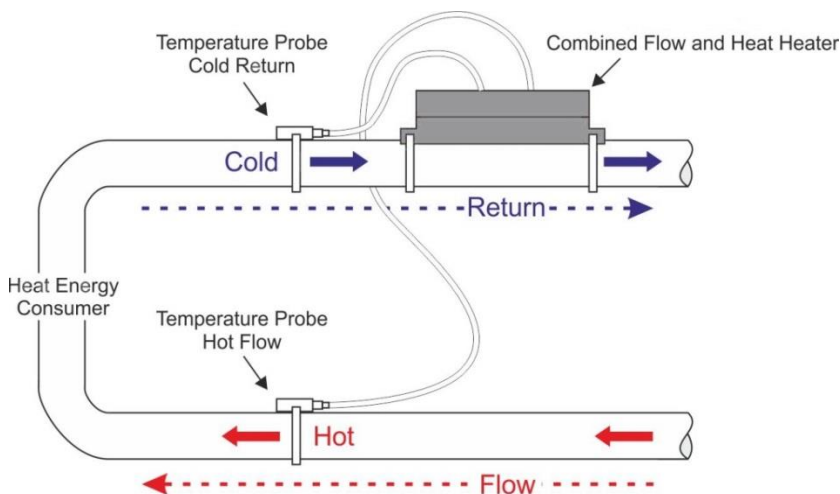

Figure 5 Typical setup of UBT for boiler applications

### 2.1.2 Clean the Pipe's Flow Sensor Contact Area

Prepare the pipe by degreasing it and removing any loose material or flaking paint in order to obtain the best possible surface. A smooth contact between pipe surface and the face of the sensors is an important factor in achieving a good ultrasound signal strength and therefore maximum accuracy.

*UBT:* The area of pipe where the temperature sensors are to be attached must be free of grease and any insulating material. It is recommended that any coating on the pipe is removed so that the sensor has the best possible thermal contact with the pipe.

## 2.2 Connect Power and Signal Cables

This section explains how to connect power and signal cables to the Electronics Module.

### 2.2.1 Power Supply

The meter will operate within the voltage range 12 - 24V DC/ 24V AC. The supply must have a minimum rating of 7W/7VA per instrument. Connect the external power supply to the Brown and Blue wires of the six-core cable.



**EXTERNAL POWER SUPPLY MUST BE CLASS 2 RATED.**



**IMPORTANT: IT IS THE RESPONSIBILITY OF THE INSTALLER TO CONFORM TO THE REGIONAL VOLTAGE SAFETY DIRECTIVES WHEN CONNECTING THE METER TO A POWER SUPPLY USING A MAINS-RATED TRANSFORMER.**

The interface cable supplied is a 6-core cable for power, pulse output and 4-20 mA (if fitted) connections.

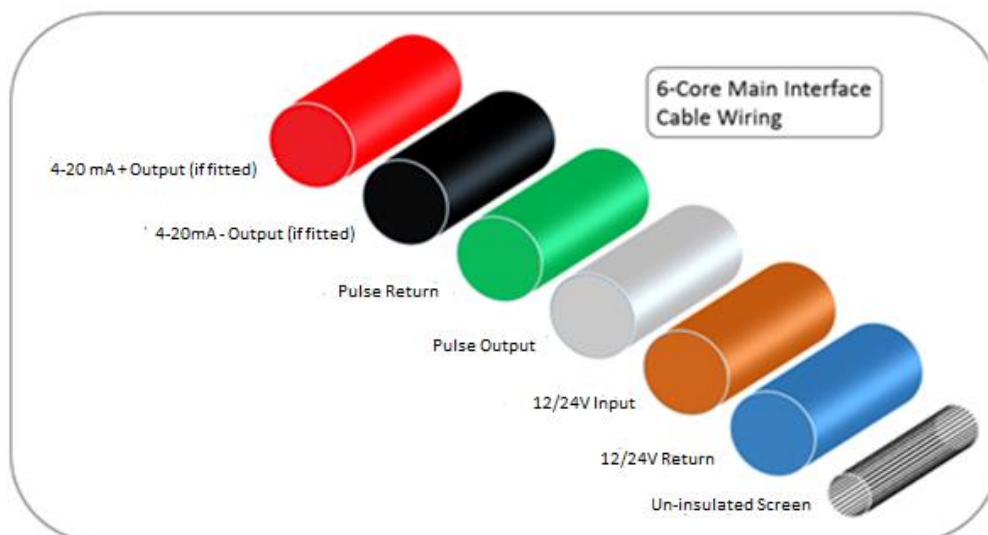

**Figure 6 6-core main interface cable**

The un-insulated wire is the connection to the screen of the cable and should be earthed for full immunity to electrical noise.

### 2.2.2 Pulse Output Connection

The isolated pulse output is provided by a SPNO/SPNC MOSFET relay which has a maximum load current of 500 mA and maximum load voltage of 24 VAC/VDC.



**THIS OUTPUT IS SUITABLE FOR SELV CIRCUITS ONLY.**

The pulse output is available at the White and Green wires. Electrically this is a Volt, or potential free contact and, when selected as a low flow alarm, is configurable NO/NC.

### 2.2.3 Current Output (UFM2 only, if fitted)

The isolated 4-20 mA is a current source and can drive into a maximum load of 620 Ω.

The 4-20 mA current output is available at the Red and Black wires. The polarities are shown in Figure 6. The alarm current due to a flow outside the range specified or due to a loss of signal is set at 3.5mA.



**THIS OUTPUT IS SUITABLE FOR SELV CIRCUITS ONLY.**

### 2.2.4 Modbus Connections (if fitted)

A separate 4 core plug-in cable is provided for the Modbus connections.

This plugs into the Electronics Module near the power cable entry.

PIN	FUNCTION	COLOR
1	MODBUS -ve	BLACK & BROWN
2	OPTIONAL GND	SCREEN
3	MODBUS +ve	BOTH WHITES
4	-	-

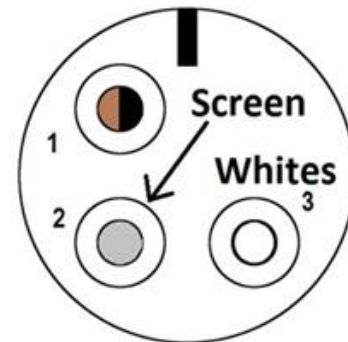

**Figure 7 Modbus Connector Cable Part - Binder 99-9210-00-04 (Front View)**

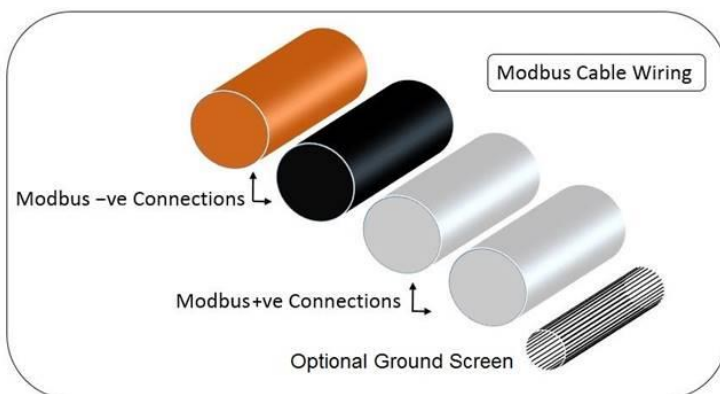

**Figure 8 Modbus cable wiring**

**NOTE: ENSURE THE WHITE WIRES ARE CORRECTLY ASSOCIATED WITH THE BLACK & BROWN WIRES. THE BLACK/WHITE TWISTED PAIR IS FITTED WITH A BLACK SLEEVE TO DISTINGUISH BETWEEN THE BLACK/WHITE AND BROWN/WHITE PAIRS.**

For reliable operation of a Modbus network the cable type and installation must comply with requirements in the Modbus specification document “[MODBUS over Serial Line Specification & Implementation guide V1.0](#)”.



**THIS OUTPUT IS SUITABLE FOR SELV CIRCUITS ONLY.**

For full immunity to electrical interference the screen of the power/pulse output cable and Modbus cable should be connected to Earth.

For full immunity to electrical interference the screen of the power/pulse output cable and Modbus cable should be connected to Earth.

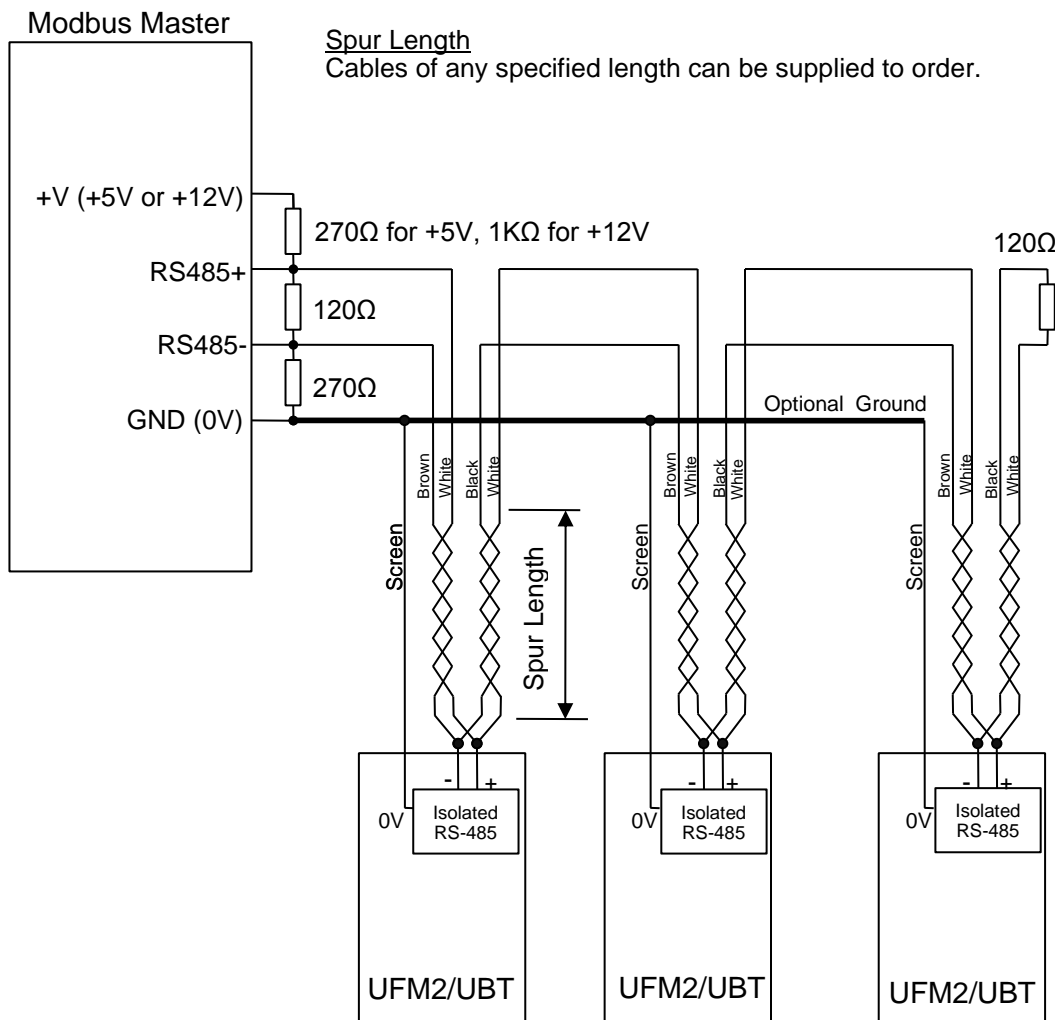

**Figure 9 Example recommended Modbus wiring diagram**

### 2.2.5 Temperature Sensor Probes (UBT only)

Two separate 4-core plug-in cables are provided for the Temperature Sensor Probes connections. These plug into the right-hand side of the Electronics Module.

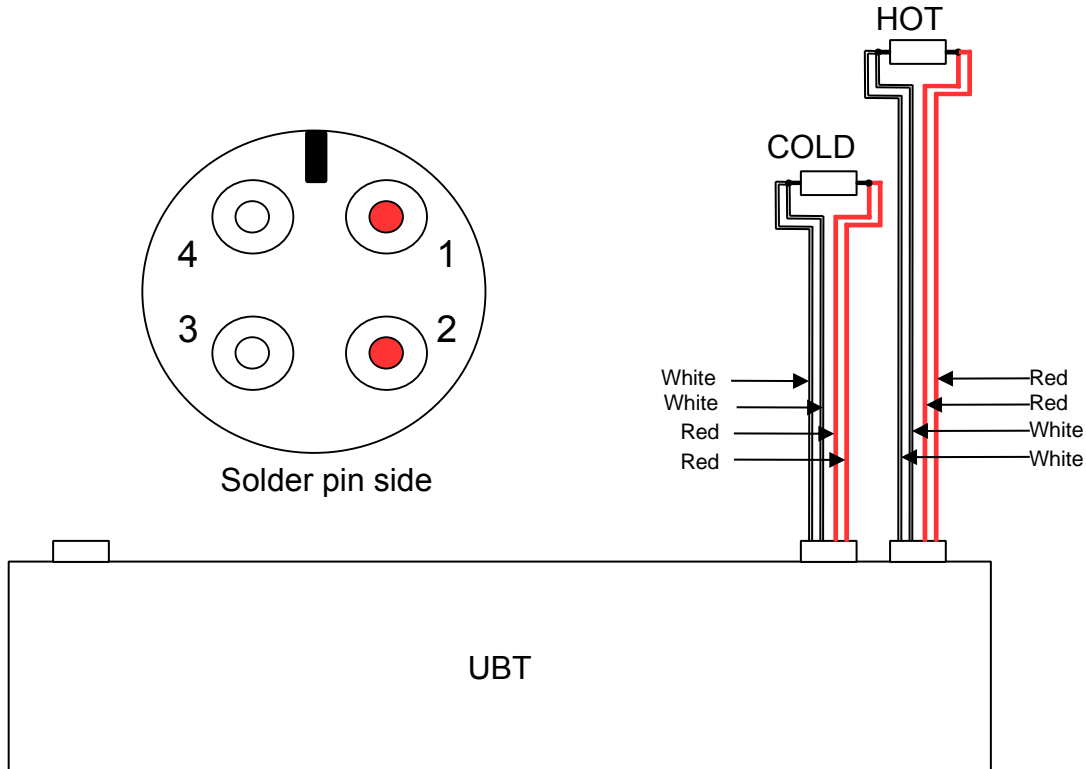

Figure 10 UBT Temperature Probe Wiring

### 2.3 Switch On

The initial screen sequence is different for the UFM2 and UBT models.

#### 2.3.1 UFM2

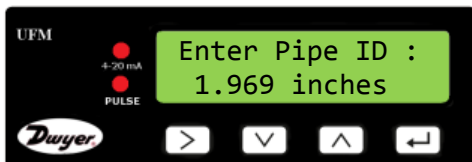

Switch on the power to the Electronics Module. A start-up screen is displayed for 5 seconds followed by hardware and software version information.

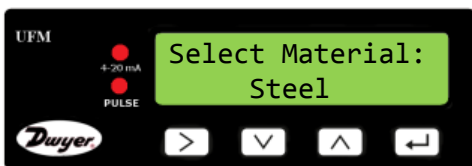

You are then prompted to enter the internal diameter of the pipe:

Use the ,  and  keys to change the value. Press  to confirm the value.



Select the pipe material by using the  and  keys to scroll through the list.

Press  to confirm the material.

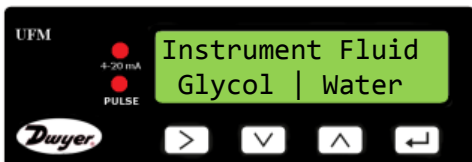

Select the fluid using the  key.

Press  to confirm the fluid name.

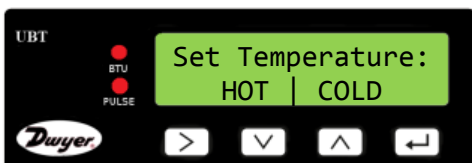

If the fluid temperature is in the range 36°F to 104°F select "COLD". If the fluid temperature is in the range 104°F to 185°F select "HOT".



The unit now shows the correct flow sensor separation (in this case, "B2") for the chosen values of pipe ID, pipe material and fluid.

Make a note of the separation code.

All subsequent start-ups will use the same configuration.

Continue with the installation of the Sensor Assembly (see page 13).





### 2.3.2 UBT



Switch on the power to the Electronics Module. A start-up screen is displayed for 5 seconds followed by hardware and software version information.

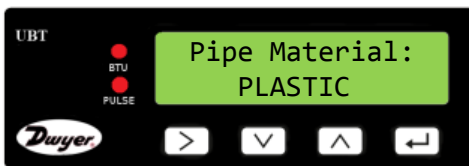

You are then prompted to enter the internal diameter of the pipe:

Use the ,  and  keys to change the value. Press  to confirm the value.



Select the pipe material by using the  and  keys to scroll through the list.

Press  to confirm the material.

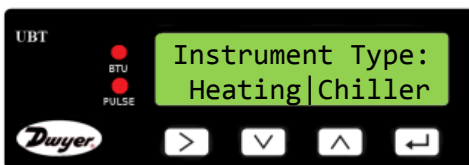

Select the instrument setting using . The unit is preconfigured for Heating applications.

Press  to confirm the setting.



Select which side the unit is installed on using . The unit is preconfigured for *Return*.

Press  to confirm the setting.



Select the fluid using .

Press  to confirm the fluid name.

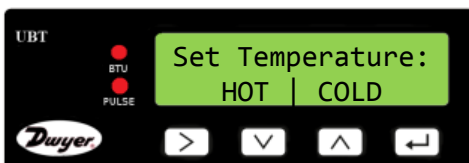

If the fluid temperature is in the range 36°F to 104°F select “COLD”. If the fluid temperature is in the range 104°F to 185°F select “HOT”.

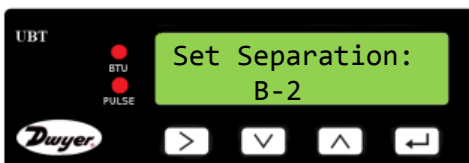

The unit now shows the correct flow sensor separation (in this case, “B-2”) for the chosen values of pipe ID, pipe material and fluid.

Make a note of the separation code.

All subsequent start-ups will use the same configuration.

Continue with the installation of the Sensor Assembly (see page 13).

## 2.4 Adjust Flow Sensor Separation

Using the separation code displayed by the Electronics Module (see page 10), take the Sensor Assembly and adjust the flow sensor separation accordingly:



**Figure 11** Loosen the flow sensor-holding screws (left); slide to correct position (right)

1. Undo the screws 2-3 turns, sufficiently to loosen the flow sensors and allow sideways movement. DO NOT fully unfasten or remove the screws at this stage.
2. Slide the flow sensors to the positions indicated on the display (e.g. “D5”).
3. With the flow sensors in the correct positions, tighten the sensor-holding screws so that the sensors are secure.

## 2.5 Apply Gel Pads

1. Apply a gel pad centrally onto the bases of each of the two flow sensors.
2. Remove the covers from the gel pads.
3. Ensure there are no air bubbles between each pad and sensor base.



**Figure 12** Applying the gel pads

## 2.6 Clamp Sensor Assembly to Pipe

The next step involves clamping the Sensor Assembly onto the pipe. Ensure that you have selected a suitable location (see pages 6 and 36) and that the pipe is clean (see page 7). If you are installing the unit on a pipe with an outside diameter less than 2.36 inches (60 mm) use one or more of the adaptors supplied with the unit.

### 2.6.1 Pipe Adaptors

The diagrams below show how the adaptors are fitted. The top 'V' shaped adaptor clips onto the ends of the Sensor Assembly and this should be used with all pipes with an outside diameter less than 2.36 inches (60 mm).

Additionally, for pipes with an outside diameter less than 1.57 inches (40 mm), a second adaptor should also be used. This fits underneath the pipe as shown below.



**IMPORTANT: DO NOT USE THESE ADAPTORS IF THE PIPE HAS AN OUTSIDE DIAMETER GREATER THAN 2.36 INCHES (60 MM).**

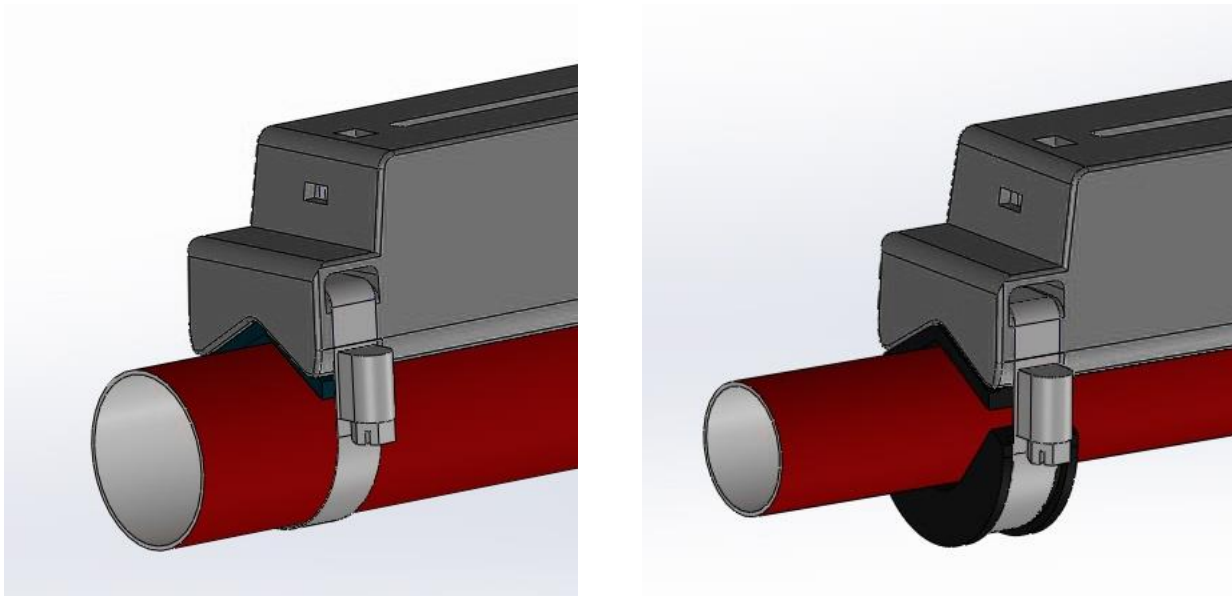

**Figure 13** Pipe adaptors in position: 1 ½ - 2 ½ " (40-60 mm) OD (left), less than 1 ¼" (40 mm) OD (right)

**2.6.2 Attaching to Pipe**

1. For pipes with an outside diameter less than 2.36 inches (60 mm), attach the black clips to the bottom of the Sensor Assembly as shown below.



**Figure 14 Attaching pipe adaptor**

2. Place the Sensor Assembly on pipe.
3. For pipes with an outside diameter less than 1.57 inches (40 mm), position the curved adaptor under the pipe.

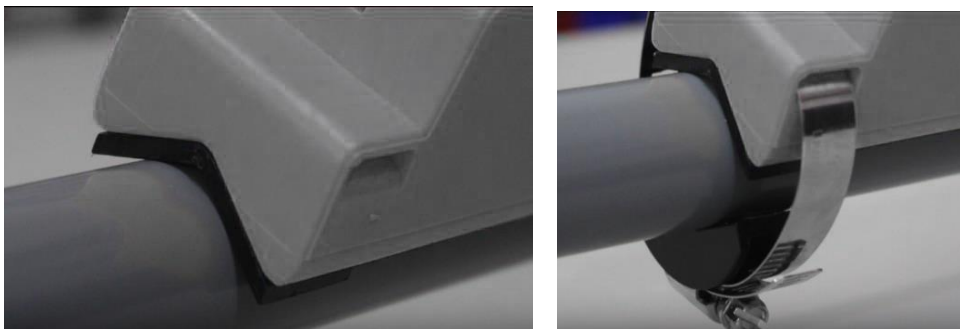

**Figure 15 Clamping pipe adaptor to pipe with OD less than 1 1/4" (40 mm)**

4. Using the hose clips provided, clamp the Sensor Assembly (and adaptors, if used) to the pipe at an angle of 45° to the top of the pipe. Experience has shown that the most consistently accurate results are achieved when the unit is mounted at this angle (see page 36). This minimises the effect of any flow turbulence resulting from entrained air along the top of the pipe and sludge at the bottom.

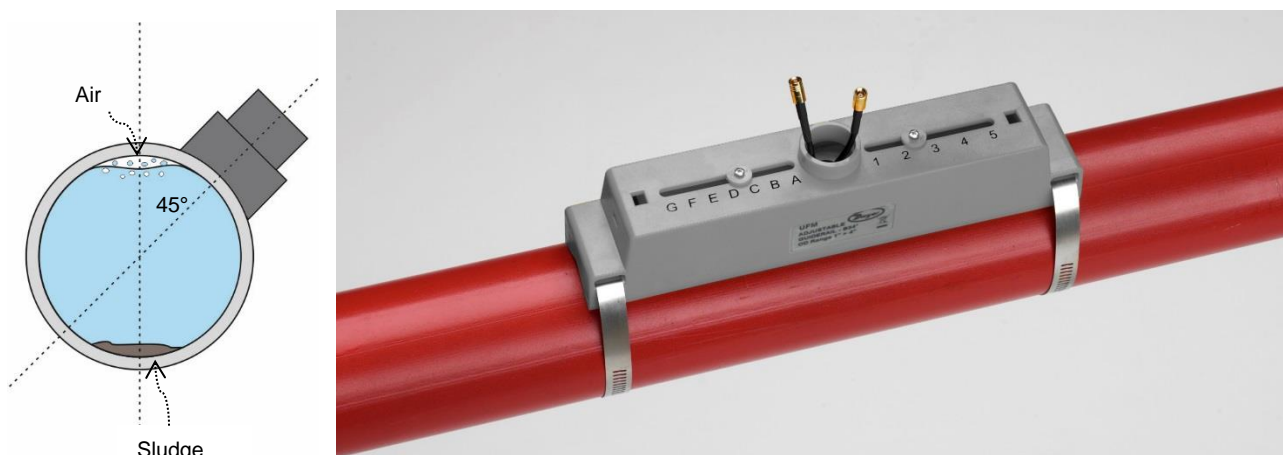

**Figure 16 Sensor Assembly clamped at 45°**

## 2.7 Remove Sensor-Holding Screws

Release and remove the sensor-holding screws. The flow sensors are spring-loaded to ensure good contact with the pipe surface.



**NOTE: THE SENSOR-HOLDING SCREWS AND WASHERS SHOULD BE KEPT IN A SAFE PLACE IN CASE IT IS NECESSARY TO RELOCATE THE UNIT (SEE PAGE 28).**



Figure 17 Removing sensor-holding screws

## 2.8 Connect Electronics Module

1. Ensure that the power is switched off.
2. Connect the Electronics Module (wired as described on page 7). The two leads can be connected either way round.



**IMPORTANT: DO NOT CLIP THE ELECTRONICS MODULE ONTO THE SENSOR ASSEMBLY UNTIL YOU HAVE CHECKED OPERATION.**





Figure 18 Connecting the Electronics Module

## 2.9 Attach the Temperature Sensors (UBT Only)



**IMPORTANT: THE TEMPERATURE SENSORS MUST BE BALANCED BEFORE INITIAL USE, USING THE PROCEDURE DESCRIBED BELOW AND USED WITH THE CABLE LENGTH SUPPLIED. EXTENDING OR SHORTENING THE CABLES WILL NEGATE THE CALIBRATION OF THE SENSORS.**

The temperature sensors must be located at the input and output of the system that is being monitored. The area of pipe where they are to be attached must be free of grease and any insulating material. It is recommended that any coating on the pipe is removed so that the sensor has the best possible thermal contact with the pipe.

The sockets on the Electronics Module are marked **Hot** and **Cold** (see Figure 19). This defines the location of the temperature sensors on installations where heat is being extracted from the system.



Figure 19 Temperature Sensor connectors on the Electronics Module

To ensure an accurate temperature differential:

1. Plug the temperature sensors into the Electronics Module and place them touching each other for 1 minute.
2. Enter the password controlled menu and scroll to the *Calibration* sub-menu (see page 20).
3. Press the Enter key until the *Zero Temp Offset* screen is displayed (see page 25).
4. Select **Yes** and press the Enter key to display the *Attach Sensors* screen.
5. Press the Enter key again and wait for instrument to return to the *Zero Temp Offset* screen.
6. Switch off the power to the Electronics Module.
7. Complete the installation of the temperature sensors. The temperature sensors have a cut out profile to locate them; they are then anchored using the supplied cable ties. The cable ties should not be over tightened or the sensors may be damaged. If the sensors are located under pipe-lagging then ensure this does not put a strain on the sensor cables.
8. Tie down the sensor cables.

## 2.10 Normal Operation

The screen sequence is different for the UFM2 and UBT models.

### 2.10.1 UFM2

Press

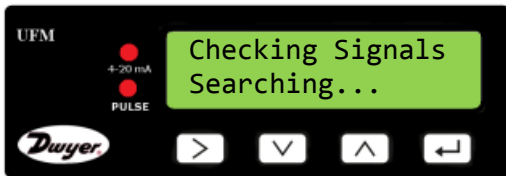

The unit checks for a valid flow signal.

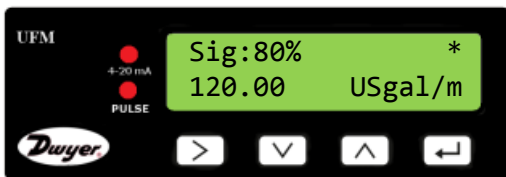

If a valid signal is found, signal strength and flow rate are displayed. The signal strength should be at least 40% for reliable operation.

### 2.10.2 UBT

Press

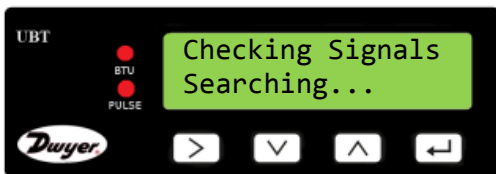

The unit checks for a valid flow signal.

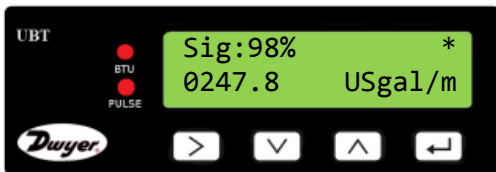

If a valid signal is found, signal strength and flow rate are displayed. The signal strength should be at least 40% for reliable operation.

Press the and keys to scroll to the *Total Flow*, *Temperature dT*, *Total Energy* and *Instant Power* screens.

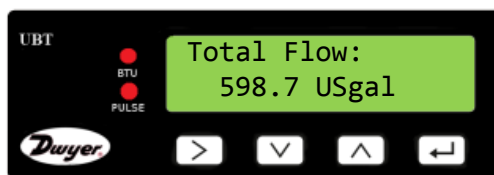
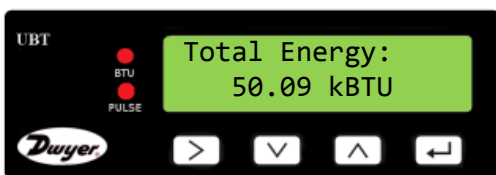
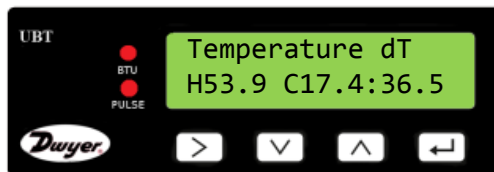
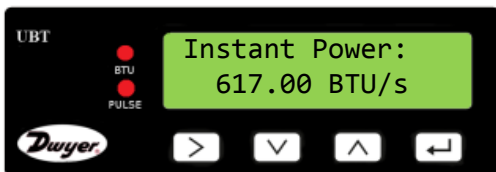



### 2.10.3 Troubleshooting the Flow Reading

The direction of flow when powered up will be taken to be the positive flow direction. The pulse output will relate to the flow in this direction. If the flow is reversed then the flow rate will still be displayed but the activity indication will change from an asterisk to an exclamation mark and no pulses will be generated.

If the flow value is displayed as “----” this indicates that there is no usable signal from the flow sensors.

The cause of this could be:

- Incorrect pipe data
- Sensor not in contact with the pipe
- Air in the liquid/pipe
- No Gel pad or grease on the sensor
- Very poor pipe condition-surface/inside

### 2.11 Clip Electronics Module to Sensor Assembly

If the unit is working correctly, clip the Electronics Module onto the Sensor Assembly. Secure in place with the screw on the right side (see Figure 21 on page 33).



Figure 20 Fully assembled UBT unit

### 3 MENUS

The password-protected menus allow you to change the default settings:

- Setup (see page 21)
- Modbus (see page 22) – *if Modbus output option installed*
- Current Output (see page 22) – *UFM2 only*
- Pulse Output (see page 24)
- Calibration (see page 25)
- Volume Totals (see page 26)
- Exit

For troubleshooting purposes, an additional Diagnostics menu is available from the main *Flow Reading* or *Total Flows* screens (see page 27).

#### 3.1 Accessing the Menus

Ensure that the instrument is in *Flow Reading*, *Total Flow*, *Temperature dT*, *Total Energy*, *Instant Power* or *Total Flow* modes, then press



Enter 71360 and then press .



The Setup Menu is displayed.

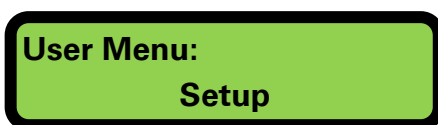

Use and to cycle through the menu sections. Press to open a menu.

To return to the Flow Reading screen, scroll to **Exit** and press .

Within a menu, press to change between two displayed options (the active setting flashes) or, if there are several options, use and to cycle through the possible values.

Press to confirm a value and display the next setting (or exit the menu if it is the last option).

### 3.2 Setup Menu

If “mm” is selected for the *Select Dimensions* option, then the temperatures will be displayed in °C and the energy values will be in kWh.

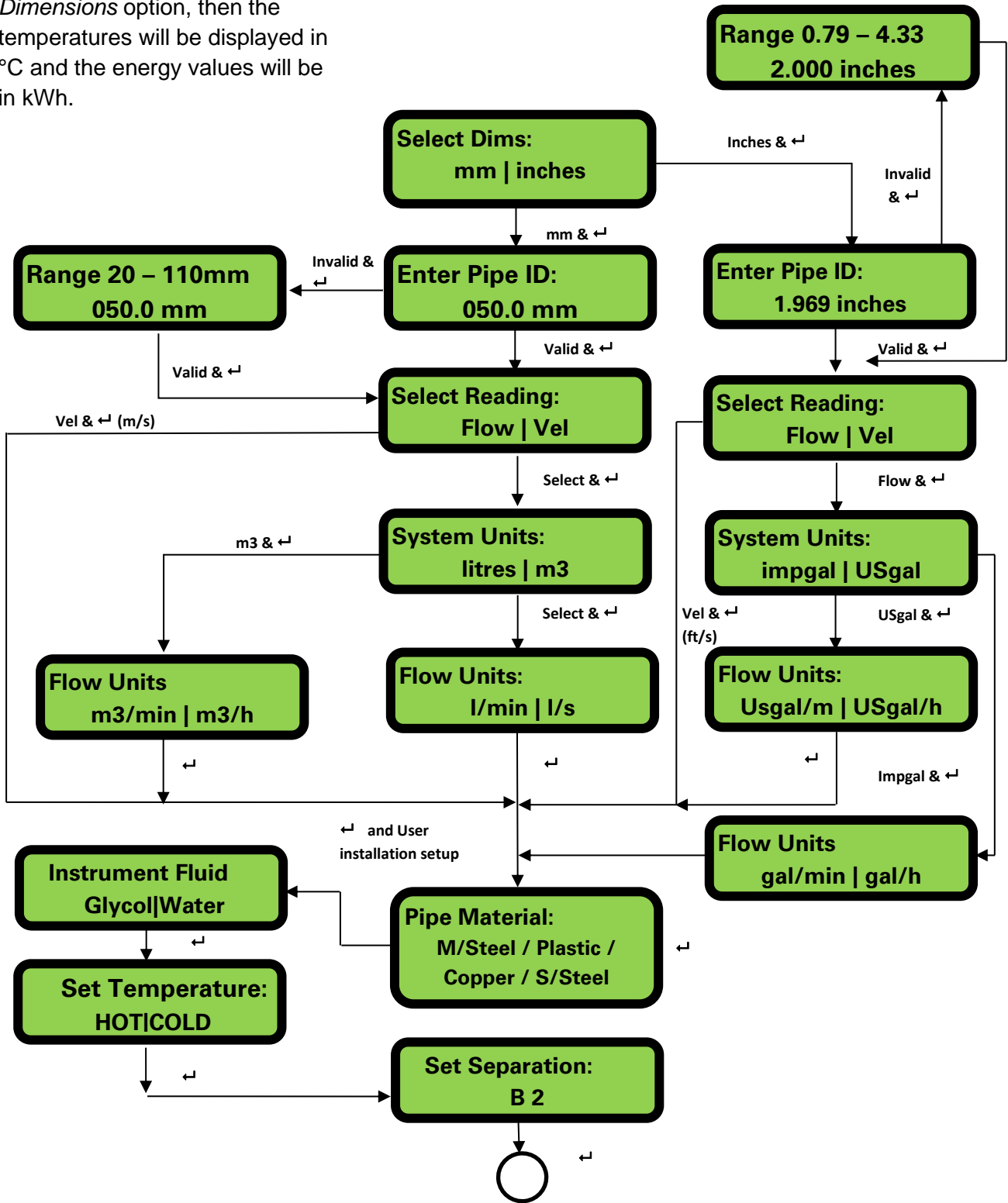

### 3.3 Modbus Menu

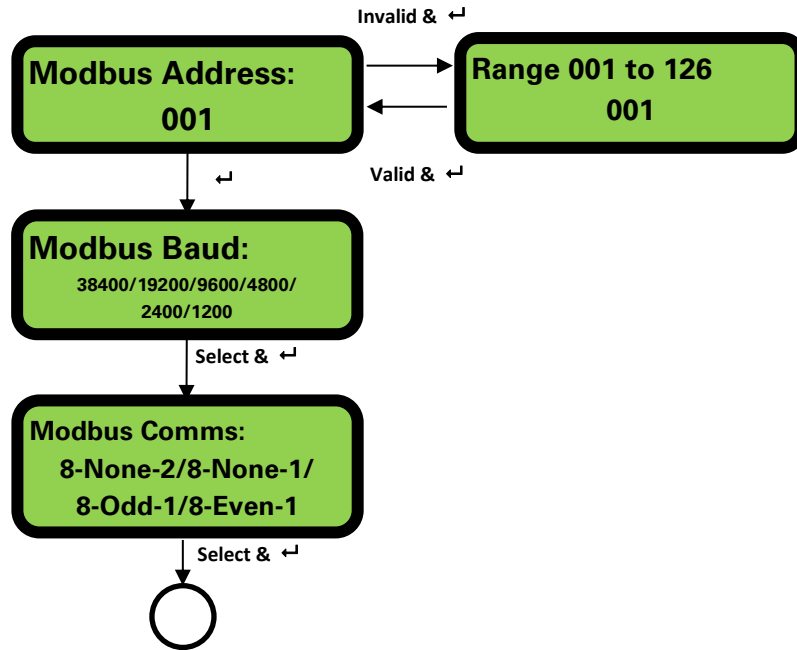

### 3.4 Current Output Menu (UFM2 only)

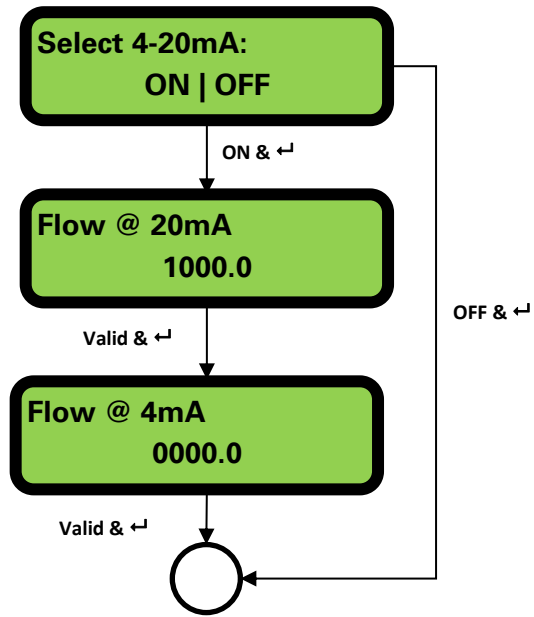

### 3.5 Pulse Output Menu

NOTE: SCREENS WITHIN THE RED BOX ARE ONLY SHOWN ON UBT MODELS.

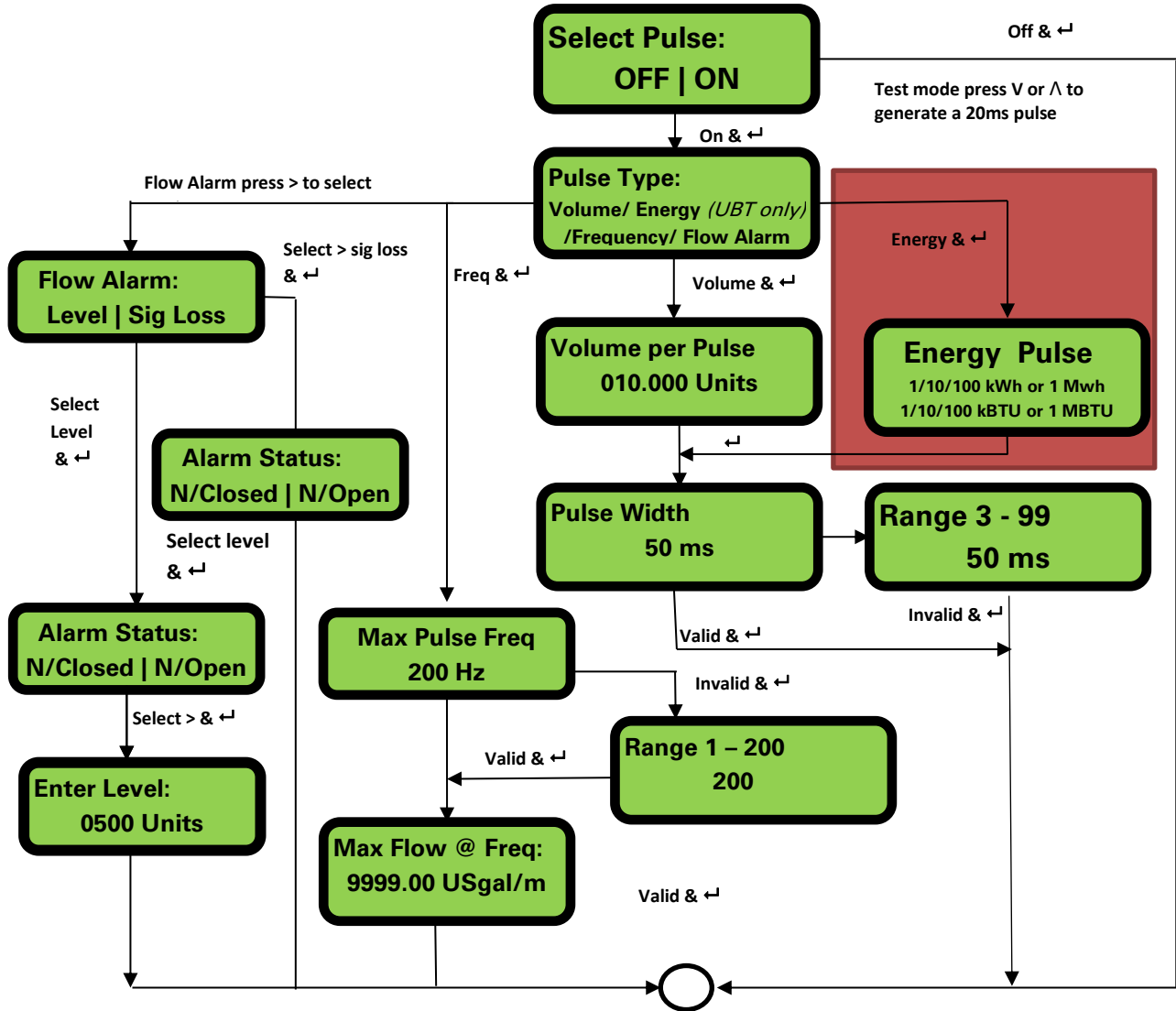







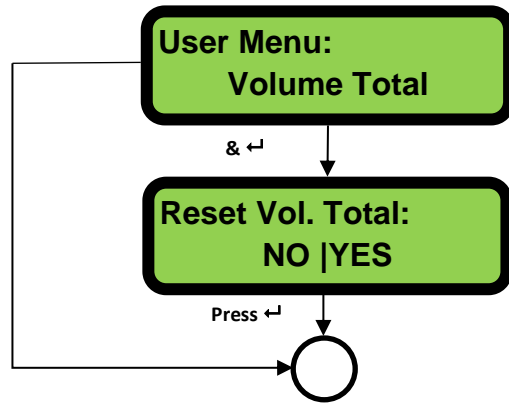

### 3.7 Volume Totals Menu



### 3.8 Diagnostics Menu

The diagnostics menu provides some additional information about the flowmeter and its setup. The menu can be accessed by pressing the  key from the main flow-reading screen. Press the  and  keys to move between the diagnostics screens. Press  to exit the Diagnostics menu.

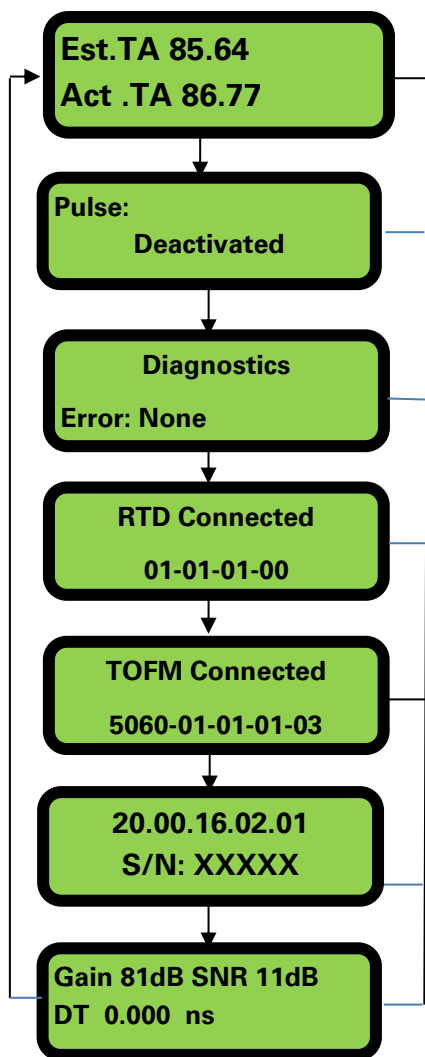

The Estimated TA (Time of Arrival) and Actual TA show the theoretical and measured transit times. If the actual value is displayed as 9999.99 then a usable signal could not be detected.

Displays the pulse status (for example): Deactivated, Volume 0.000 litres, Signal Loss, Alarm(On) 500.0 USgal/min, Alarm(Off) Signal Loss, Frequency 100.00 Hz.

This screen will display the Errors. A number between 0-255 will be displayed. If no errors reported "None" is displayed.

The RTD board's software version is shown on the lower line. The upper line shows its status.

The flow board's software version is shown on the upper line. The lower line shows its status.

The unit's software version is shown on the upper line. The lower line shows the unit's serial number.

Gain – a decibel number between -5dB and 80dB – *lower is better*, should be around 40dB or below. Above 60dB need to question the installation. Signal/Noise ratio in dB, scale is 0 to 80dB – *higher is better*. Below 20 question the installation. The lower line shows the current time differential between the upstream and downstream signals.

## 4 OUTPUTS

### 4.1 Pulse Output

Pulse output can be set up to operate one of five modes:

- Volumetric
- Energy (UBT only)
- Frequency
- Low Flow Alarm
- Loss of Flow (Signal) Alarm

The Alarm functions allow you to set the alarm switch to *Normally Open* or *Normally Closed*.

#### 4.1.1 Volumetric Pulse

The default pulse width is set to 50ms which represents half of one pulse cycle. A 50ms pulse width is required for most mechanical counters.

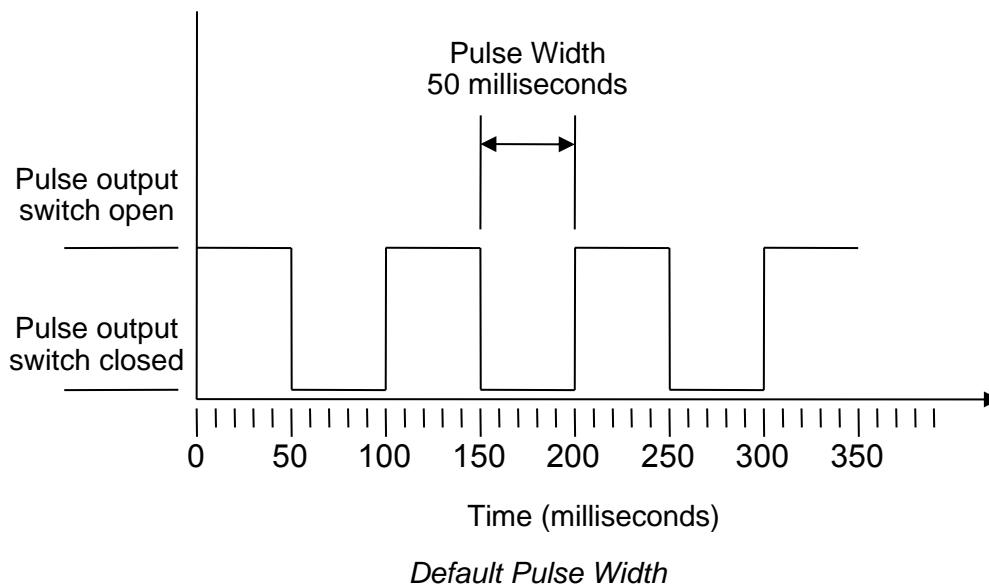

Formula to obtain Volume per Pulse based on a (default) 50 ms pulse width:

Volume per Pulse  $\geq$  maximum flow rate (in litres per minute) / 600

Example for maximum flow rate of 500 USgal/min:

Volume per Pulse  $\geq$  500 USgal/min / 600 = 0.833 USgals per pulse

Rounding up to nearest whole litre:

Set **Volume per Pulse** to **1 USgal**.

### 4.1.2 Frequency Mode

In Frequency mode, the output frequency is proportional to the flow rate within a specified frequency range of 1 – 200Hz.

### 4.1.3 Energy Pulse (UBT only)

When the *Pulse Output* is set to **Energy**, the kWh LED will be permanently illuminated. Choose from 1,10,100kWh or 1MWh when in metric mode and 1,10,100kBTU or 1MBTU in imperial mode. Each pulse represents an amount of energy e.g. 1BTU. The same limitation on maximum pulse rate applies as detailed in the Volumetric Mode. Again a larger unit of energy per pulse or a smaller pulse width may be required.

### 4.1.4 Flow Alarm - Low Flow

For the Low Alarm the user can set a range between 0 and 9999 (no decimal places), in the same units being used to measure flow. The default setting is normally open, but the user can select between N/O and N/C. There is a 2.5% hysteresis on the switching of the output. Once the low flow alarm is activated, the flow rate must rise by 2.5% more than the set value to deactivate the alarm again.

### 4.1.5 Flow Alarm - Signal Loss

If the flow reading (signal) is lost, as indicated by the flow rate being displayed as “-----“, the alarm will be triggered. The default setting is normally open, but the user can select between N/O and N/C.

## 4.2 4-20 mA Current Output (UFM2 only)

The default 4-20 mA output setting is OFF, and the 4-20 mA LED on the keypad will not be illuminated. The default flow for 4 mA is 0. This can be changed, see page 22.

If the flow reading is greater than that set as the 20 mA value, or there is negative flow, or no flow signal can be detected, then an alarm current of 3.5 mA will generated.



**NOTE: THE 4-20MA CURRENT OUTPUT IS FACTORY CALIBRATED.**

### 4.3 Modbus (if fitted)

The Modbus RTU interface is configured via the Modbus sub menu.

- Float byte order –AB CD – Big endian – MSB first.
- The data rate can be selected in the range 1200 to 38400 baud.
- The address can be set in the range 1 to 126.
- Minimum Polling Rate 1000 ms (1 s). Time out after 5 seconds.
- The unit will only respond to Modbus requests while operational, while the flow reading, volume total, energy total, power or temperature screens are displayed.
- If the flow reading is invalid then the flow value will be zero.
- If a UBT temperature sensor goes out of range then the value will go to 12.2°F (-11°C).

The above faults will set the relevant status bit (see page 38).

On a unit set to Imperial the temperature is in °F, Power is in BTUs and flow in US Gallons.

The UFM2/UBT complies with the Modbus specification document:

[http://www.modbus.org/docs/Modbus\\_Application\\_Protocol\\_V1\\_1b.pdf](http://www.modbus.org/docs/Modbus_Application_Protocol_V1_1b.pdf)

The following registers are available.

Register Offset	Type	Typical Contents	Meaning	Notes
n/a	Byte	0x01	Instrument Address	
n/a	Byte	0x03	Instrument Command	
n/a	Byte	0x40	Number of bytes to read	
0	Int-16	0x00 0xac	Device ID	0xAC UFM2/UBT
1	Int-16	0x00 0x00	Status	0x0000 OK Not[0x0000] Fault
2	Int-16	0x00 0x04	System Type UBT only	0x04 Heating system 0x0C Chiller system
3	Int-16	0x00 0x01	Serial Identifier	
4	Int-16	0x23 0x45		
5	Int-16	0x60 0x00		
6	IEEE754 float	0x40 0x1f		
7		0x67 0xd3		
8	IEEE754 float	0x41 0x8c	Measured Velocity	Units in m/s
9		0xd8 0xb0		
10	IEEE754 float	0x42 0x1c	Measured Flow	Units in m <sup>3</sup> /hr for Metric Units in US Gal/m for Imperial
11		0x2e 0x34		
12	IEEE754 float	0x44 0x93	Calculated Power (UBT only)	Units in kW for Metric Units in BTU/s for Imperial
13		0xc6 0xe8		
14	IEEE754 float	0x41 0x98	Calculated Energy (UBT only)	Units in kWh for Metric Units in BTU for Imperial
15		0x00 0x00		
			Measured Temperature (Hot) (UBT only)	Units in Degrees Celsius for Metric Units in Degrees Fahrenheit for Imperial

(continued)

Register Offset	Type	Typical Contents	Meaning	Notes
16	IEEE754 float	0x41	Measured Temperature (Cold) (UBT only)	Units in Degrees Celsius for Metric Units in Degrees Fahrenheit for Imperial
17		0x88 0x00 0x00		
18	IEEE754 float	0x40	Measured Temperature (Difference) (UBT only)	Units in Degrees Celsius for Metric Units in Degrees Fahrenheit for Imperial
19		0x00 0x00 0x00		
20	IEEE754 float	0x60	Measured Volume Total	Units in m <sup>3</sup> for Metric Units in US Gal for Imperial
21		0xef 0x3c 0x1c		
22	Int-16	0x00 0x00	Instrument Units	0x00 Metric 0x01 Imperial
23	Int-16	0x00 0x01	Instrument Gain	Gain in dB
24	Int-16	0x00 0x0a	Instrument SNR	SNR in dB
25	Int-16	0x00 0x62	Instrument Signal	Signal in %
26	IEEE754 float	0x42	Measured Delta-Time Difference	Diagnostic Data Units in nanoseconds
27		0xc9 0xff 0x7d		
28	IEEE754 float	0x42	Instrument ETA	Diagnostic Data Units in nanoseconds
29		0xa8 0x8b 0xf5		
30	IEEE754 float	0x42	Instrument ATA	Diagnostic Data Units in nanoseconds
31		0xc8 0x00 0x00		
n/a	Int-16	0xed 0x98	CRC-16	

## 5 RELOCATING THE UNIT

If it is necessary to relocate the unit use the following procedure:

1. Disconnect the temperature sensors (UBT only) and MODBUS cable (if used).
2. Unfasten hose clips and remove the complete unit from the pipe.
3. Undo the screw at the end of the Sensor Assembly and gently lift the same end of the Electronics Module as shown below.
4. The opposite end of the Electronics Module can now be released from the Sensor Assembly.



**Figure 21** Separating Sensor Assembly and Electronics Module

5. Disconnect the two wires connecting the Sensor Assembly and Electronics Module.
6. Remove the original gel pads from the two sensors.
7. Push the sensor blocks into the Sensor Assembly so that the washers and locking screws can be refitted.
8. Place replacement gel pads on the base of the sensors.
9. Follow the procedure for re-installing the unit on the pipe (see page 14).



## 6 APPENDIX

### 6.1 Specification

General	
Measuring Technique	Transit time
Measurement channels	1
Timing Resolution	±50ps
Turn down ratio	200:1
Flow velocity range	0.33 – 32.8 ft/s (0.1 to 10m/s)
Applicable Fluid types	Clean water with < 3% by volume of particulate content, or up to 30% ethylene glycol.
Accuracy	±3% of flow reading for velocity rate >0.98 ft/s (0.3 m/s)
Repeatability	±0.15% of measured value
Pipe Ranges	3/4-4" (25-115mm) OD and 5-7" (125-180mm) OD Note: Pipe size is dependent on pipe material and internal diameter.
Selectable units for USCS	Velocity: ft/s Flow rate: gal/min, gal/hr, USgal/min, USgal/hr Volume: gals, USgals
Selectable units for metric	Velocity: m/s Flow Rate: l/s, l/min, m³/min, m³/hr Volume: litres, m³
Totaliser	14 digits with roll over to zero
Languages supported	English only
Power input	12 – 24V DC or 24V AC
Power consumption	7W DC or 7VA AC maximum
Cable	16.4 ft (5m) screened 6 core
Pulse Output	
Output	Opto-isolated MOSFET volt free contact (NO/NC).
Isolation	1MΩ @ 100V
Pulse width	Default value 50ms; programmable range 3 – 99ms
Pulse repetition rate	Up to 166 pulses/sec (depending on pulse width)
Frequency mode	200 Hz maximum (Range 1-200)
Maximum load voltage/current	24V DC or 24V AC / 500mA
Current Output <i>UFM2 only (if fitted)</i>	
Output	4 – 20mA
Resolution	0.1% of full scale
Maximum load	620Ω
Isolation	1MΩ @ 100V
Alarm current	3.5mA

*continued on next page*

continued from previous page

Modbus (if fitted)	
Format	RTU
Baud rate	1200, 2400, 4800, 9600, 19200, 38400
Data-Parity-StopBits	8-None-2, 8-None-1, 8-Odd-2, 8-Even-1
Standards	PI-MBUS-300 Rev. J
Physical connection	RS485
Temperature sensors	
Type	PT100 Class B 4 wire
Range	36 to 185°F (2 to 85°C)
Resolution	1°F / 0.1°C
Sensor Accuracy	±1.305°F (±0.725°C)
Enclosure	
Material	Plastic Polycarbonate
Fixing	Pipe mountable
Degree of Protection	IP54
Flammability Rating	UL94 V-0
Dimensions	10 inches x 2 inches x 3.6 inches (250 mm x 48 mm x 90 mm) (electronics module + sensor assembly)
Weight	1.1 lb (0.5 kg)
Environmental	
Maximum Pipe temperature	32°F to 185°F (0°C to 85°C)
Operating temperature (Electronics)	32°F to 122°F (0°C to 50°C)
Storage temperature	14°F to 140 °F (-10°C to 60°C)
Humidity	90% RH at 122°F (50°C) Max
Maximum altitude	4,000 m
Indoors/outdoors	Indoors
Wet locations	A location in which water or other liquid can drip, splash, or flow on or against electrical equipment.
Pollution degree	3: Conductive pollution or dry nonconductive pollution that becomes conductive due to condensation.
Display	
LCD	2 line x 16 characters
Viewing angle	Min 30°
Active area	3.27" (W) x 0.75" (H) 58 mm (W) x 11 mm (H)
Keypad	
Format	4 key tactile feedback membrane keypad



**SERVICING OR REPAIRS TO THE UNIT CAN ONLY BE CARRIED OUT BY THE MANUFACTURER.**

## 6.2 Default values

The settings will be configured at the factory for metric units. The following table lists the metric and imperial default values.

Parameter	Default Value	
	Metric	Imperial
<b>Dimensions</b>	mm	inches
<b>Flow Units</b>	l/min	USgal/min
<b>Pipe size (ID)</b>	3/4-4": 50 mm 5-7" pipes: 127 mm	1" to 4" pipes: 1.969 in 4" to 6" pipes: 5.000 in
<b>Pulse Output</b>	Off	Off
<b>Energy per Pulse</b> <i>(UBT only)</i>	1kW	1 kBTU
<b>Volume per Pulse</b>	10 litres	2.642 US gallons
<b>Pulse Width</b>	50 ms	50 ms
<b>Damping</b>	20 seconds	20 seconds
<b>Calibration Factor</b>	1.000	1.000
<b>Zero Cut-off</b>	0.02 m/s	0.07 ft/s
<b>Zero Offset</b>	0.000 m/s	0.000 ft/s

## 6.3 Limitations with Water-Glycol Mixtures

There is little available data on the specific heat capacity (K factor) for water glycol mixes and there is no practical method of determining the percentage of glycol in a system or the type of glycol in use. The flow calculations are based on a Water/Ethylene glycol mix of 30%.

In practical terms the results should not be considered more than an approximation as:

The fluid speed of sound can vary between 1480 ms and 1578 ms

No temperature compensation curve is available for water/glycol mixes,

The percentage of Glycol can vary the specific heat capacity from 1.00 to 1.6 J/M3 \* K

The type of glycol added can change the specific heat capacity and fluid speed of sound considerably.

The Factory enabled user set-up of the application relies on the installer to set the correct operating parameters, a considerable variation in results can be obtained from incorrectly set-up units.

## 6.4 Positioning

For accurate measurements, the UFM2/UBT must be installed at a position where the fluid flows uniformly. Flow profile distortions can result from upstream disturbance such as bends, tees, valves, pumps and other similar obstructions. To ensure a uniform flow profile, the unit must be mounted away from any cause of flow disturbance.

As a guide, we suggest this is best achieved by ensuring there is a straight length of pipe upstream of the transducers of at least 10 times the pipe diameter, and 5 times the pipe diameter on the

downstream side, as shown in Figure 3, but this may vary. Flow Measurements can be made on shorter lengths of straight pipe, but when the transducers are mounted this close to any obstruction the resulting errors can be unpredictable.

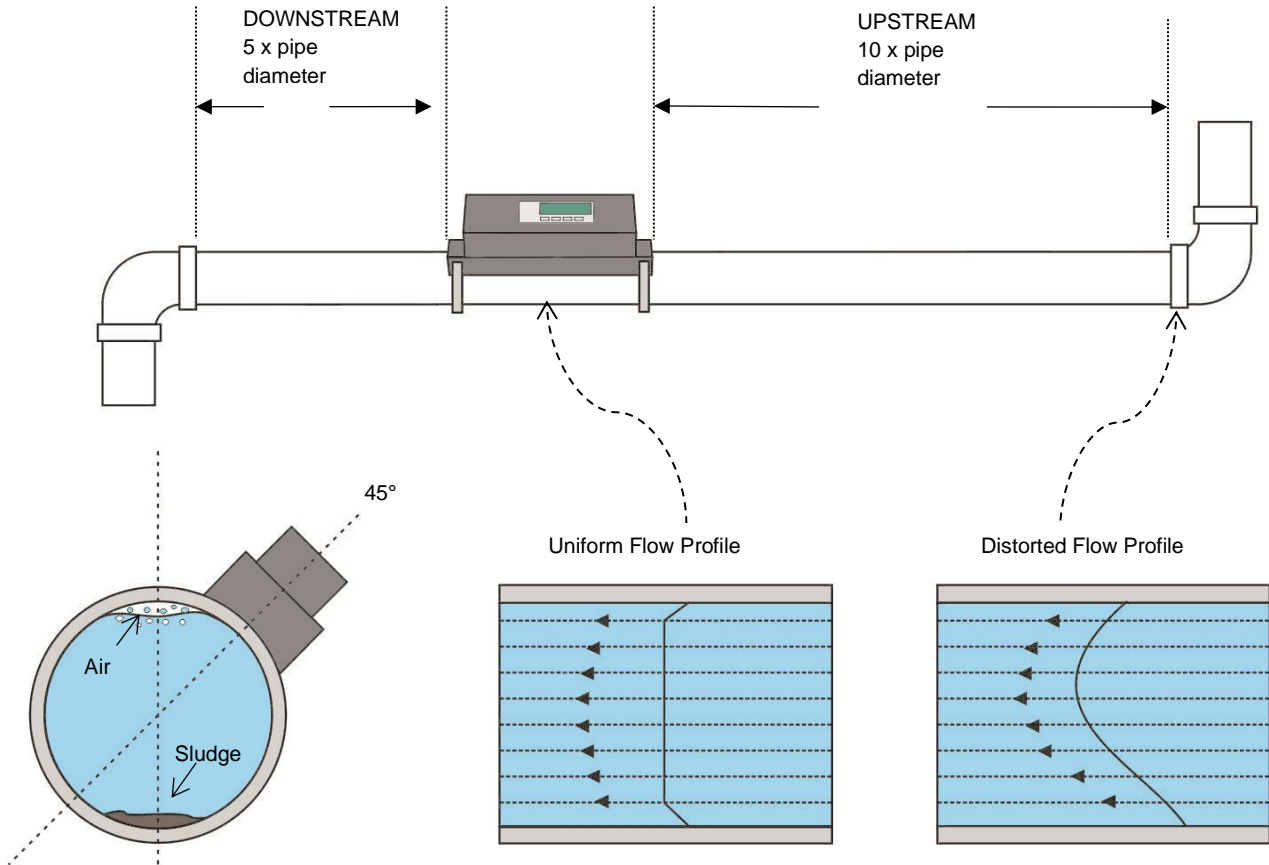

**Figure 22 Location of unit**

To obtain the most accurate results, the condition of both the liquid and the pipe must be suitable to allow ultrasound transmission along the predetermined path.

In many applications, an even flow velocity profile over a full 360° is unattainable due, for example, to the presence of air turbulence at the top of the flow and also possibly sludge at the bottom of the pipe. Experience has shown that the most consistently accurate results are achieved when the sensors are mounted at 45° with respect to the top of the pipe. In chiller applications, the meter's sensor/electronics must be mounted at 45° with respect to the top of the pipe to prevent condensation entering the electronics unit.



**IMPORTANT: DO NOT EXPECT TO OBTAIN ACCURATE RESULTS IF THE UNIT IS POSITIONED CLOSE TO ANY OBSTRUCTION THAT DISTORTS THE UNIFORMITY OF THE FLOW PROFILE. DWYER INSTRUMENTS, INC. ACCEPTS NO RESPONSIBILITY OR LIABILITY IF PRODUCT HAS NOT BEEN INSTALLED IN ACCORDANCE WITH THESE INSTRUCTIONS.**

## 6.5 Error and Warning Messages

### 6.5.1 Error Messages

Error Messages are displayed as a number in the diagnostics menu. Contact Dwyer Instruments if other messages appear.

Error Meaning	Status Byte								Value
	Bit#7	Bit#6	Bit#5	Bit#4	Bit#3	Bit#2	Bit#1	Bit#0	
RTD I2C failed <i>(UBT only)</i>								1	1
RTD Thot failed <i>(UBT only)</i>							1		2
RTD Tcold failed <i>(UBT only)</i>						1			4
TOFM signal lost					1				8
TOFM board failed				1					16
TOFM window failed			1						32
TOFM sensor type failed		1							64
TOFM I2C failed	1								128

### 6.5.2 Example Error Messages

Error Message	Error Meaning
None or 0	None
2	Hot sensor error <i>(UBT only)</i>
4	Cold sensor error <i>(UBT only)</i>
6	Hot and Cold sensor error <i>(UBT only)</i>
8	No flow signal
10	Hot error and no flow signal <i>(UBT only)</i>
12	Cold error and no flow signal <i>(UBT only)</i>
14	Hot and Cold error and no flow signal <i>(UBT only)</i>

### 6.5.3 Modbus Error Messages (if Modbus fitted)

Test case	Transmitter							
	Address	Command	Start Register		Length (no of registers)		CRC-16	
	[1 byte]	[1 byte]	[2 bytes]		[2 bytes]		[2 bytes]	
No error	0x01	0x03	0x00	0x00	0x00	0x20	0x44	0x12
Incorrect function request	0x01	0x0C	0x00	0x00	0x00	0x20	0x10	0x13
incorrect register start	0x01	0x03	0x00	0xEF	0x00	0x20	0x75	0xE7
Incorrect register length	0x01	0x03	0x00	0x12	0xFF	0x02	0x25	0xFE
slave is busy	0x01	0x03	0x00	0x00	0x00	0x20	0x44	0x12
incorrect CRC-16	0x01	0x03	0x00	0x20	0x00	0x20	0x44	0xFF

Receiver					Comments
Address	Command	Error code	CRC-16		
[1 byte]	[1 byte]	[1 byte]	[2 bytes]		
0x01	0x03	None	n/a	n/a	Example of a good message
0x01	0x8C	0x01	0x85	0x00	ILLEGAL FUNCTION - the only acceptable command is 0x03
0x01	0x83	0x02	0xC0	0xF1	ILLEGAL DATA ADDRESS - incorrect register start
0x01	0x83	0x03	0x01	0x31	ILLEGAL DATA VALUE - incorrect register length
0x01	0x83	0x06	0xC1	0x32	SLAVE DEVICE BUSY – unit is busy processing and is unable to respond
0x01	0x83	0x07	0x00	0xF2	CRC is incorrect

### 6.5.4 Flow Errors

A signal strength of less than 40% indicates poor set up of the instrument, and the installation should be checked or possibly moved to a different site.

### 6.5.5 Flow Warnings

A signal strength of less than 40% indicates poor set up of the instrument, and the installation should be checked or possibly moved to a different site. A negative flow is indicated by an "!" being displayed on the top line instead of a "\*".

### 6.5.6 Data Entry Errors

These generally advise you that the data entered is not within the specified range:

**Range 0.79 – 4.33**  
**1.969 inches**

Displayed when an invalid Pipe ID is entered, prompting the user to enter a value between 0.79 and 4.33 inches depending on the product purchased.

**Calibrate Error**  
**Press Enter**

An attempt has been made to zero the offset between the temperature sensors, and the difference in temperature is too large. Ensure the temperature sensors are correctly plugged in and are both at the same temperature.

**Range 1 - 200**  
**200**

When programming a Frequency Pulse output the frequency is limited to the range 1 to 200 Hz.

**Range 3 - 99**  
**0000.0**

When programming a Volume Pulse output the pulse width is limited to the range 3 to 99ms.

**Range 0.00 – 0.500**  
**0000.0**

When programming the Zero Cut-off this is limited to the range 0.000 to 0.500.

**NOTE: THIS MUST BE SET TO ZERO BEFORE PERFORMING A ZERO OFFSET.**

**Range 0.500 – 1.500**  
**0000.0**

When programming the Calibration Factor this is limited to the range 0.5 to 1.5.





