



## Series RSMC StabiliSENSE™ Critical Room Status Monitor

### Specifications - Installation and Operating Instructions



RSMC with standard plastic bezel

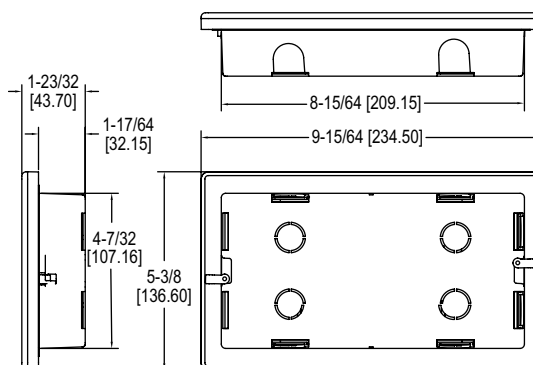

The **Series RSMC StabiliSENSE™ Critical Room Status Monitor** is designed for critical low differential pressure applications that require stringent pressure monitoring and alarming. It can be configured to monitor positive or negative pressure in clean rooms, hospital isolation rooms, school nurses offices, laboratories, and vivariums. The RSMC is a complete system with a touchscreen graphical user interface which enables access to pressure, humidity, temperature, air change, security, door status, calibration, and alarm setup. The graphical display color changes allow a clear determination of when the parameters are operating within the acceptable range (green), caution range (yellow), or have gone outside the acceptable operating range (red). The RSMC StabiliSENSE™ critical room status monitor comes standard with BACnet MS/TP and Modbus® RTU communications.

#### 1.0 INTRODUCTION

The Dwyer® Series RSMC monitors room parameters in a variety of applications. Its ease of installation and intuitive setup, provides a great user experience. While the RSMC is easy to operate, it is advisable to read this manual carefully before use. It is designed to allow the user to take full advantage of the function and performance of the Series RSMC.

#### 1.1 INTENDED USE

The Series RSMC is designed to monitor critical air environments, provide room pressure indication and 3 additional user-defined parameters user-selectable as temperature, relative humidity, air change per hour (ACH), door status, and/or additional pressure measurements. The RSMC Series has alarming and data communication over Modbus® RTU or BACnet MS/TP. The applications of the RSMC include:

1. Hospitals - patient isolation and protection rooms, operating suites, intensive care, and emergency rooms.
2. Precision manufacturing - pharmaceutical, semiconductor, and clean rooms.
3. Laboratories - medical research, bio-safety labs (BSLs), and vivariums.

#### 1.2 RSMC FUNCTION

The Series RSMC senses low differential pressure using a capacitive cell pressure sensor. The RSMC senses the differential pressure between a protected environment, such as a clean room or isolation room, and an area outside the room. Maintaining a constant differential pressure between the two spaces is critical in ensuring the room is protected by ingress for the outer room or vice-versa. The RSMC can be programmed to monitor either positive or negative room static pressure in 1 to 3 locations. In total, it can monitor up to 4 parameters: built-in differential pressure, up to 2 additional differential pressures as inputs, relative humidity input, air change per hour (ACH) input, and door status. The touchscreen user interface allows for easy setup of the multi-parameter alarming and 2 levels of security protection. The BACnet communications allows the device to communicate with other BACnet devices, such as sensors, and allows the supervisory system to change configuration setups and monitor alarm conditions.

#### SPECIFICATIONS

**Service:** Air.

**Measurement Technology:** Capacitance cell pressure sensor.

**Wetted Materials:** Front: PMMA window with IP65 rating; Back housing: Fire-proof ABS+PC UL 94 V-0.

**Pressure Limits:** 1.5 psig.

**Accuracy:**  $\pm 0.25\%$  RSS (includes non-linearity:  $\pm 0.24\%$  BFSL, hysteresis:  $\pm 0.05\%$  and non-repeatability:  $\pm 0.05\%$ ), or  $\pm 0.5\%$  RSS (includes non-linearity:  $\pm 0.49\%$  BFSL, hysteresis:  $\pm 0.05\%$  and non-repeatability:  $\pm 0.05\%$ ).

**Process Connection:** Barbed, fits 1/8" and 3/16" (3 mm and 5 mm) ID rubber or vinyl tubing.

**Inputs:** Two (2) user-selectable 4-20 mA, 0-5 VDC, or 0-10 VDC; USB type C used for cloning programming; One (1) digital input for door status.

**Outputs:** One (1) digital output (DO) rated 5 A @ 30 VDC; One (1) 4-20 mA or 0-10 V (user selectable) corresponding to internal pressure or retransmission of any input.

**Ambient Temperature Limits:** 32 to 122°F (0 to 50°C).

**Power Requirements:** 24 VAC/VDC.

**Selectable Pressure Units:** Pa, kPa, cm w.c., mm w.c., and in w.c.

**Temperature Units:** °F and °C.

**Zero and Span Adjustments:** Adjustable via touchscreen.

**Power Consumption:** 3.6 W @ 24 VDC.

**Electrical Connection:** Removable terminal block.

**Display:** 4.3" (10.9 cm) color TFT LCD, dimmable; 480 x 272 resolution.

**Communications:** Modbus® RTU, BACnet MS/TP.

**Audible Alarm:** 69.1 dB 10 cm from display.

**Weight:** 1.05 lb (0.476 kg).

**Compliance:** BTL, CE.

## 2.0 MOUNTING

The Series RSMC is designed to be mounted flush into a wall or panel. Use the included cardboard cut-out as a template to ensure proper wall cut-out dimensions. After cutting a 4.21" x 7.91" hole (107 mm x 201 mm), push the junction box into the wall orienting the 2 screw tabs upward and push the box into the cutout, as shown in Figure 1. Next use a screwdriver to secure the 2 screw tab wall locks. After the junction box is installed firmly into the wall or panel, carefully push the RSMC into the junction box as shown in Figure 2 below (after wiring the terminal block). The rear housing will snap into the junction box.

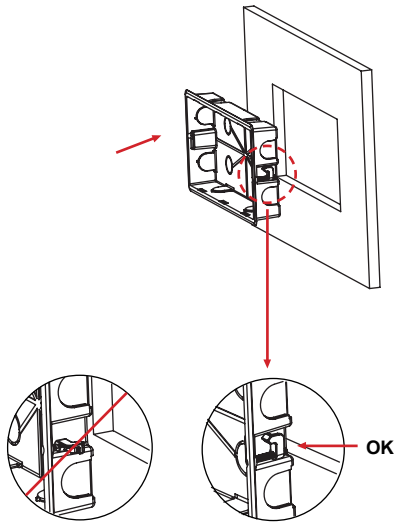

Figure 1

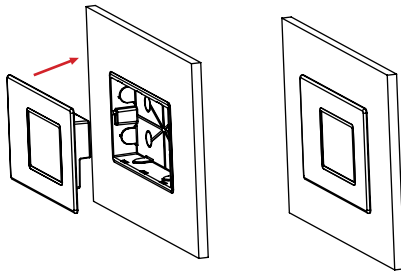

Figure 2

The front panel can be removed from the junction box by pushing downwards on the top lip of the bezel. The downward force will release the snap clips, then the front panel can be pulled out as shown in Figure 3 below.

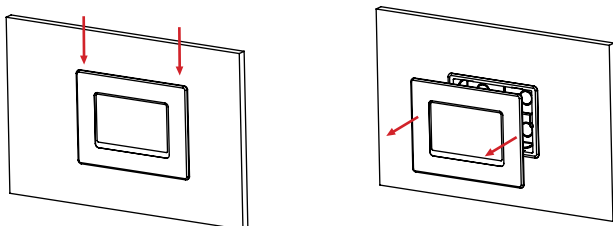

Figure 3

## 2.1 WIRING ELECTRICAL BOX (ROUGH IN)

Layout the system in terms of wiring: power, analog output, BACnet, relay output, digital inputs, analog inputs and plumbing to connect to the monitored spaces. Run all power, earth ground, signal communications and analog output wiring into the RSMC junction box. Follow all local electrical codes and refer to the wiring diagrams on this page and the back label of the RSMC for proper terminal locations.

The RSMC includes one digital output which may be wired to a local audible or visual alarm or may be wired to a controller to indicate an alarm condition. The RSMC contains one analog output that linearly corresponds to the reading of the built-in pressure sensor. The RSMC contains 2 built-in analog inputs. The analog inputs are capable of accepting 4-20 mA, 0-5 VDC, or 0-10 VDC analog transmissions. The analog inputs may be assigned as differential pressure, temperature, relative humidity, or air change per hour (ACH). One analog input can also be assigned as a digital input for use as a door status indicator. This input setup is performed in the input/output menu.

### Power supply minimum requirements:

EN 55032 CISPR 32  
FCC Part 15 Subpart B

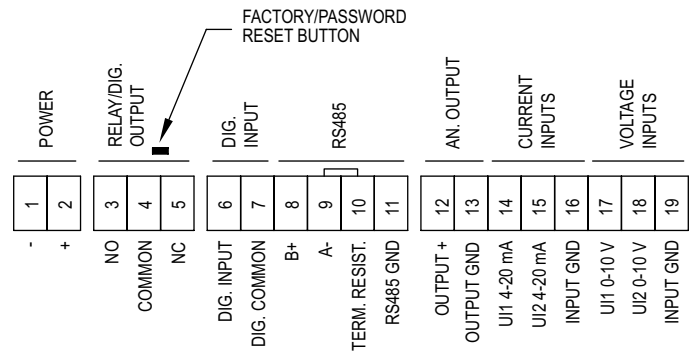

## 2.2 ATTACHING PRESSURE TUBING

Use 1/8" or 3/16" (3 mm or 5 mm) ID rubber or vinyl tubing (adapters as necessary) to transition from any pre-installed tubing to the barbed pressure fittings on the RSMC. For the most stable pressure operation, a room pressure pickup installed in the reference pressure area is also recommended.

For measuring a room maintaining a positive pressure, connect one end of tubing to the room pressure pickup in the room and the other end to the "+" barbed connection on the back of the RSMC.

For measuring a room maintaining a negative pressure, connect one end of tubing to the room pressure pickup in the room and the other end to the "-" barbed connection on the back of the RSMC.

## 3.0 BASIC OPERATION AND SOFTWARE CONFIGURATION

The RSMC home screen is continuously displayed to the end-user, ensuring the room environmental conditions are clearly visible. The screen is designed to display room parameters, and enable touchscreen operation when changes in room conditions are needed, when additional information is desired, or if alarms need to be acknowledged. A few of the key elements of the screen are described and shown below.

The RSMC provides visual representation where each of the parameters are either in normal (green), within the caution stage (yellow), in the alarm state (red) and in cleaning mode (blue).

The caution (yellow) stage and alarm (red) state are programmed by the supervisor. The caution stage can be selected and adjusted to be within a few points from the low and high limit setting. As the monitoring parameter comes closer to the set value the display will transition from green to a yellow color to warn the staff. If any of the parameter readings go outside of the acceptable setting, it will change to a red color, start blinking, and the internal built-in audio will begin beeping.

During the alarm state, a speaker icon will show in the middle at the top of the display if enabled. Pressing this icon will silence the audible alarm. Adjacent to the speaker icon to the left will be a bell icon representing the interlock, if enabled.

### 3.1 CONFIGURATION MENU

Upon applying power, the unit will display the Dwyer® logo on the screen. If the unit is not yet configured, it will go through the initialization sequence and begin the setup wizard. If the unit is configured, it will show the home screen. After the unit goes through the initialization sequence, the screen will display the home screen, which is the view that will be continuously displayed. To access the Configuration menu from the home screen, press the Settings (gear icon) button in the top right corner of the screen.

### 3.2 INITIAL SETUP WIZARD

The RSMC will load the setup wizard, which will guide the user through the initial setup. The screen will appear in the order below and can be navigated using the touchscreen interface.

- Language selection
- USB Configuration or Local Configuration
  - If USB is selected, the setup wizard moves to a screen instructing how to copy parameters with the USB stick. Then the setup wizard moves to the Room Settings to allow the Room Name to be changed; followed by the Save/confirmation screen. A USB-C to USB-A drive must be used to copy parameters from one RSMC to another.
  - If Local is selected, it will move on to the next steps below.
- Display mode
- Communications
- Inputs
- Outputs
- Alarm
- Room settings
- Display settings
- Save/confirmation screen

In the Configuration menu, one of three modes to display the parameters can be selected.

1. 1 Room: Monitoring of 4 parameters: 1 binary signal (1 door contact), 1 built-in differential pressure, and 2 analog or BACnet inputs to be select by the user.
2. 2 Rooms: Monitoring 4 parameters: 1 built-in differential pressure, 2 analog or BACnet inputs to be select by the user, and 2 binary contacts.
3. 3 Rooms: Monitoring 6 parameters: 1 built-in differential pressure, 2 analog or BACnet inputs to be select by the user; and 3 binary contacts (wired in series).

Examples of 1 room, 2 room, and 3 room setups are shown below.



1 room



2 rooms



3 rooms

### 3.2 LANGUAGE SELECTION

The RSMC supports English and Spanish languages, additional languages will become available via firmware updates. To select the desired language, press the Settings (gear) icon on the home screen, then select “Language.”



### 3.3 USB CONFIGURATION

The RSMC can be setup with a USB drive. A USB-C to USB-A drive must be used to copy parameters from one RSMC to another. The Duplicate Cloning menu can be accessed by clicking on the Settings(gear) icon on the home screen, then Maintenance, then Duplicate Cloning.

Duplicate/Cloning permits copying the RSMC configuration to and from a USB thumb drive - the purpose of this is to replicate the configuration on other devices or units that may be replaced in the field. Please refer to section 6.3 for Duplicate Cloning instructions.

### 3.4 DISPLAY MODE

The home display is configurable and can be adjusted to the end users needs. To access the Display Mode, click on the settings icon on the home screen, then select Display Mode. The user can select 1 to 3 rooms and 1 to 3 sensors.

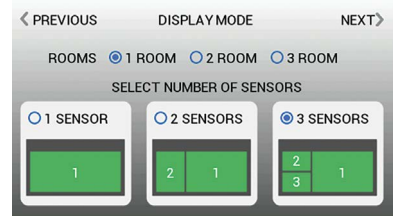

### 3.5 NETWORK

The RSMC is capable of Modbus® RS-485 and BACnet communications. To access the network settings, click on the settings icon on the home screen, select configurator, then select Network. Set Modbus® or BACnet MS/TP network information in the Network screen.

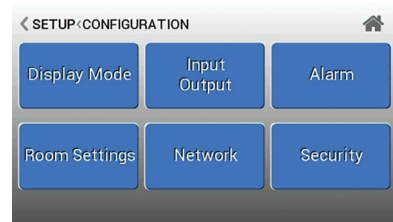

### 3.6 INPUTS

The RSMC is capable of accepting 2 analog inputs and 1 digital input. Analog inputs from the transmitters can be selected as: 4-20mA, 0 to 5VDC or 0 to 10 VDC. The RSMC contains a digital input contact for door status monitoring. Additionally, 1 analog input can be setup as a digital input. The Inputs menu can be accessed by clicking on the settings icon on the home screen, then select Configurator, followed by Input/Output, then selecting Input.

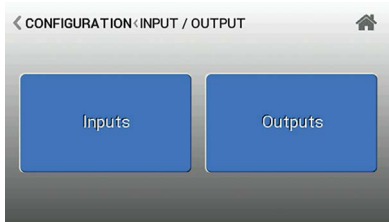

The inputs can be assigned to any room. The factory installed differential pressure sensor is identified as "Built-in Pressure". The two remote analog inputs are user selectable, identified as "User Input 2" and "User Input 3". While the binary input is identified as "Binary Input 1". User Input 2 and User Input 3 can be set to display temperature, relative humidity, air changes per hour (ACH), another differential pressure input, or configured to be set as a binary input.

Binary Input 1 can only be a digital input, it cannot be configured to another input type. Configuration of the Built-in Pressure selection is limited to selecting the units and number of decimal places, the range cannot be configured.

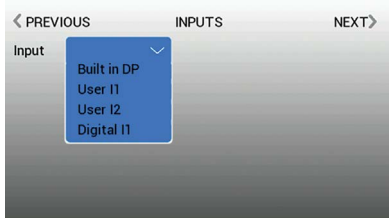

User inputs configuration screen

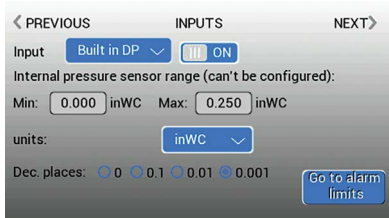

Built-in DP configuration screen

To enter a numerical value, select the field and a floating keyboard will appear. Press the green checkmark key to change the value of the field and make the keyboard disappear as shown below. To change a value you must backspace (orange button) over the existing value first.

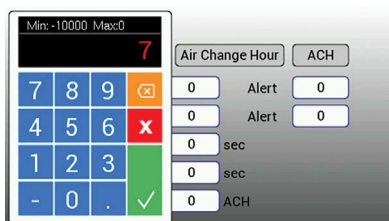
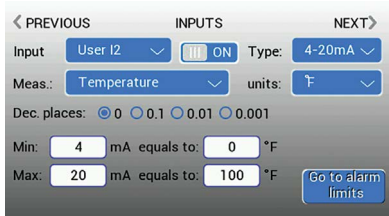

### 3.6 INPUTS (continued)

At the Input screen select the input to be configured. Define the signal type based on the transmitter output to be either milliamp (mA), DC voltage (VDC), or contact (Digital).

The input signal can then be scaled using Minimum and Maximum signal values that match the full-scale range of the applicable transmitter. For example, 0 VDC corresponds to the minimum range of the sensor and 5 VDC corresponds to the maximum range of the sensor.

In the Measurement box, the user can define the type of measurement (temperature, humidity, etc) and the desired engineering units to be displayed.

If ACH (Air Changes per Hour) is selected, duct dimensions need to be entered when the input type is selected as volumetric flow. When using an air velocity sensor for ACH calculation, the input must be scaled to convert to volumetric flow. To do this, scale the low and high input values for 4-20 mA, 0-5 V, or 0-10 V by multiplying by the cross-sectional area of the duct where the air velocity sensor is installed.

For ACH, the room volume should be input by the user after measuring the room the RSMC will be monitoring. Air flow in CFM can be calculated from an air velocity sensor reading in feet per minute or FPM.

The user can adjust low and high pre-alarm trigger and alarm set points for the ACH measurement.

Set the Low and High Measurement Values that correspond to the full-scale range of the transmitter and the appropriate number of decimals places to be displayed for the measurement value.

Tap "Go to Alarms" to set the alarms limits and warnings.

The below figures show BI1 (digital input only) and UI2/UI3 when they are set as Digital Inputs in the configuration screen.

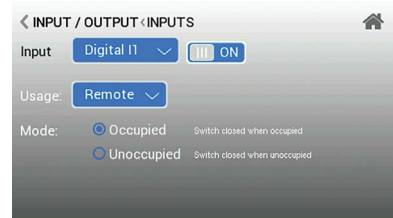

If the signal input type for UI3 is set as "Digital," and "DOOR" is selected as the usage, then UI3 will represent a door contact or door status switch. Selecting Normal Polarity means the switch is open when the door opens, and the switch is closed when the door is closed. Selecting Reverse Polarity means the switch is open when the door is closed, and the switch is closed when the door is open. For a digital input, the delay time allows the user to set a time delay before a visual indication is shown on the screen that the door is opened.

### 3.6 INPUTS (continued)

"REMOTE" Usage allows an operator, or staff outside of the room, to set the Room to Occupied or Standby (standby representing either Cleaning or Unoccupied). If the RSMC is configured via BACnet, the user can program the remote input for all three options; Occupied, Unoccupied and Cleaning.

To set Binary Input 1, the same steps for User Input 3 outlined previously are used. This is usually used for one of the door contacts or for multiple door contacts in series.

### 3.7 OUTPUTS

The RSMC supports 1 binary output and 1 analog output (4-20 mA and 0-10 V selectable) that corresponds to the reading of the built-in piezoresistive differential pressure sensor. The Outputs menu can be accessed by clicking on the Settings icon on the home screen, selecting Configurator, selecting Input/Output, then selecting Output.

There is one relay contact with "Normally Closed" and "Normally Open" connections available. This is selectable by choosing which Output Type Source to use.

The 4-20 mA or 0-10 V output cannot be configured to correspond to a different measurement other than the built-in differential pressure.

The source that will drive the relay can be set up to be any of the following:

- Master Alarm: The relay changes state when any alarm occurs in any of the rooms
- Door Alarm: The relay changes state when any door alarm occurs in any of the rooms
- Pressure Alarm: The relay changes state when any pressure alarm occurs in any of the rooms
- Analog Alarm: The relay changes state when any analog input alarm occurs in any of the rooms
- Room XXXXX Alarm: The relay changes state when the specific room parameter alarm occurs in the selected room.
  - Where XXXXX is the parameter of the room (See Rooms Settings)
- None – the relay will not be driven by any source.



### 3.8 ALARMS

The Alarm Settings menu is where all the alarm and warning functions are defined. Both low and high limits can be changed to Enabled or Disabled individually and set to audio only, visual only, or both audio and visual. The alarm menu can be accessed by clicking on the settings icon on the home screen, selecting Configurator, then selecting Alarm.

For a positive pressure room a high limit may not be required. If this is the case, the High Alarm can be set to Disabled. For a negative room, a low limit may not be required. If this is the case, the Low Alarm can be set to Disabled.

"Alarm Delay" is the time between when one of the parameter values falls beyond an alarm condition (Low or High Limit) and when an audible, visual, or output alarm condition occurs. Use the "Alarm Delay" when time is needed for door entry and personnel access. "Return to Normal" delay is the opposite; when a parameter value goes out of alarm and now falls within normal range, the audible, visual, and output alarm conditions will persist for this period of time or until the alarm condition is cleared.

"Alarm Deadband" is a value that is added or subtracted to a limit when determining if a parameter has returned to a normal state. For example, if a temperature parameter is set with a low alarm limit of 66.5 degrees and the deadband set at 1.0 degrees, but the temperature falls to 66.5 and goes into an alarm, the temperature must then return to a value greater than 67.5 to trigger the alarm state to change from alarm to normal function. Alarms are available for all parameters.

### 3.8 ALARMS (continued)

For Analog Parameters:

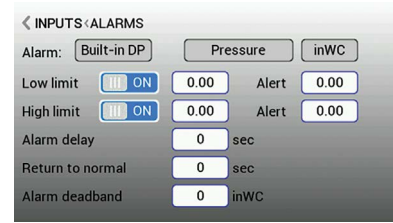

For Digital Parameters:



The high and low alarm levels are enabled by choosing "ON". The alarm levels are set by entering the value desired. These settings apply to all alarm behaviors.

The warning alert set point for the analog parameters is when the display changes from green to yellow to provide a visual warning that the parameter is getting close to the unacceptable or alarm condition. The warning alert set point is the amount above the low limit alarm, or below the high limit alarm set points when the display color change is desired.

The Interlocking function causes an alarm condition to persist even when the parameters have returned to normal operating ranges. For the interlocked alarm to be cleared, it must be acknowledged at the touchscreen of the RSMC. This function is useful when it is important for staff present in the room to acknowledge the alarm by responding.



Interlocking alarm icon shown on bottom right

Enabling the Audible Alarm causes the audible alarm within the RSMC unit to sound when in alarm condition. If disabled, the alarm will still be visible on the RSMC screen. If the RSMC is set up over the network, it will activate the alarm via the binary output relay; the binary output relay is configurable.

Audible Alarms could have the potential to be disruptive. If Audible Alarms are needed, test several settings to optimize an appropriate volume for the environment; One second after volume selection, the buzzer will beep briefly to provide a sample of the volume level.

Mute Timeout is the amount of time an acknowledged alarm will be silent. When an audible alarm occurs, a staff member can silence the alarm by tapping the Mute Sound icon. Upon pressing it, the Mute Timeout starts counting down from the number of seconds configured. When the countdown time goes to zero and the cause of the alarm condition persists, the audible alarm will sound again. The amount of seconds should be long enough for the staff to acknowledge it, but not be overly disruptive.

### 3.9 ROOM SETTINGS

Room Settings is where each input is assigned a name and where the source of the data is selected. After defining in Display Mode the room numbers and the parameters to show, selection of where the parameter values come from is required. There are two possibilities: the analog sensors are wired into the RSMC unit or they are connected through the BACnet network. To access room settings, click the settings icon on the home screen, click configurator, then click ROOM SETTINGS.

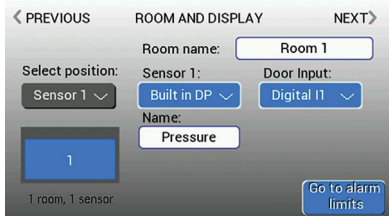

**1 room and 1 parameter example**

In the example above, the sensor position must be tapped and the sensor type can be selected as well.

Selecting the Room Name input box shows a keyboard to input the name.

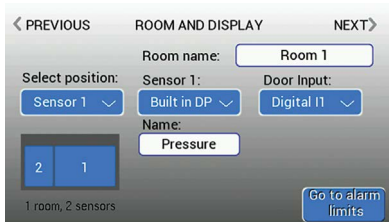

**1 room and 2 parameters example**

Select the sensor display position in the box on the left side, then select the sensor assigned to the display position to the right next to "select sensor". If the BACnet option is selected, the user has to input the BACnet address and sensor type of the remote sensor.

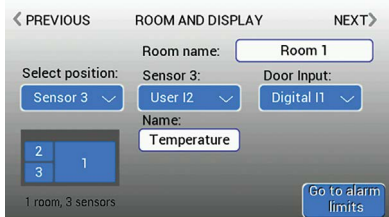

**1 room and 3 parameters example**

Select the sensor display position in the box on the left side, then select the sensor assigned to the display position to the right next to "select sensor". If the BACnet option is selected, the user has to input the BACnet address and sensor type of the remote sensor.

### 3.9 ROOM SETTINGS (continued)

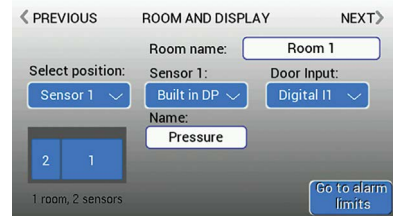

**2 rooms and 3 parameters example**

Select the sensor display position in the box on the left side, then select the sensor assigned to the display position to the right next to "Select Sensor". If the BACnet option is selected, the user has to input the BACnet address and sensor type of the remote sensor.

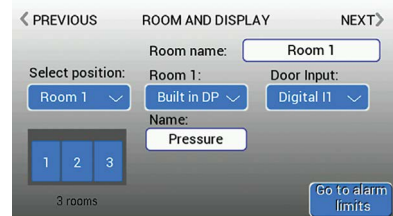

**3 rooms and 3 parameters example**

Select the sensor display position in the box on the left side, then select the sensor assigned to the display position to the right next to "select sensor". If the BACnet option is selected, the user has to input the BACnet address and sensor type of the remote sensor.

After completing the room settings, the user can select each parameter from each room in order to use it at the alarm configuration or output configuration. Each parameter is named with the room name and the selected sensor. For the above example the parameter is named "Packaging A1\_DP".

### 3.10 DISPLAY SETTINGS

The RSMC has display parameters that are user-adjustable. To access display settings, click the settings icon on the home screen, click Configurator, then click DISPLAY SETTING.

Adjust the backlight intensity bar to increase/decrease the display brightness. Brightness levels can be set individually for when the room is occupied or unoccupied/cleaning. Lower the light intensity to obtain longer hours of operation to minimize display brightness degradation. The backlight intensity can also be adjusted via BMS control over BACnet on a schedule.

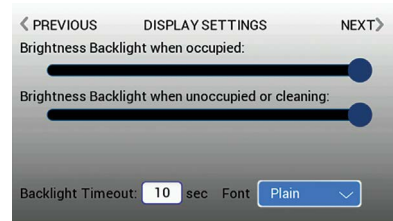

### 4.0 SECURITY

The Security menu is where the user sets the password access to the RSMC functions. If Password Security is not enabled, anyone will have full, unrestricted access to any function of the RSMC unit via the touchscreen. When security is enabled, a Supervisor and Operator Password are enforced for the Operating and Setup screens. When a user attempts to access the set points, the Operator Password is requested. When a user attempts to access any functions from the Setup screen (such as I/O or network configuration), the Supervisor Password will be requested.

#### 4.0 SECURITY (continued)

**Note:** If the Supervisor Password has been setup and forgotten, the only recovery method is to perform a factory reset of the unit, which will wipe out all configuration settings. To perform a factory reset, press and hold the button located on the back of unit above terminal block pins 4 and 5. The connector for the second terminal block may need to be removed for easier access.

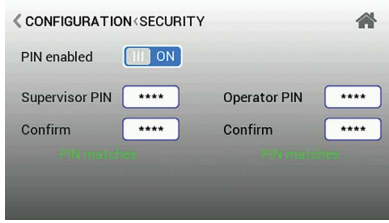

#### Passcode Setup

The Operator security level allows access only to alarm acknowledgement and to change the room modes from occupied, unoccupied and cleaning. The operator should be defined as the person(s) that has day-to-day interaction with the monitor to change room operating modes (when no alarms are active). The operator and staff can also respond to local audible and visual alarms. If Operator Password is enabled then a password will be needed before changes can be made. The Supervisor Level allows full access to all levels of the menu structure. This mode, if enabled, is used during initial configuration and follow-up reconfiguration.

#### 5.1 DIAGNOSTICS

The Diagnostics menu performs I/O and BACnet tests on the unit. The Diagnostics menu can be accessed by clicking the settings icon on the home screen, then selecting Diagnostic.



Diagnostic screen

#### I/O Testing

In the I/O Testing menu, the screen will show the Inputs and Outputs selections. The unit has the capability to choose the input desired from the pull-down menu; the input value (volts or mA) and the corresponding calculated output value (in the Eng. units selected) will be displayed if a sensor is properly connected.

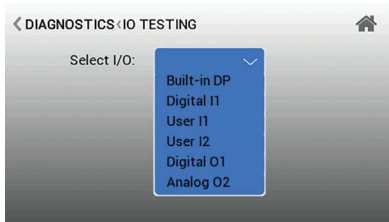

#### 5.1 DIAGNOSTICS (continued)

If the user chooses the Output B11 they can view the output value and the user can also change the state.



#### 6.0 MAINTENANCE

The Maintenance menu provides several functions that help ensure the RSMC is configured and operating accurately with proper parameters. To access the Maintenance menu from the home screen, press the Settings icon in the top right corner and select the Maintenance button.

Within the maintenance menu, the following maintenance functions can be accessed:

- Calibration of the built-in pressure sensor
- Date and Time allows manual or BACnet setting of date/time and customization of the date/time display
- Duplicate/Cloning permits copying the RSMC configuration to and from a USB thumb drive – the purpose of this is to replicate the configuration on other devices or units that may be replaced in the field
- Software Update – in the event of software upgrades or new features that could become available from Dwyer Instruments
- Reset To Factory Default – restores the unit's original factory configuration.

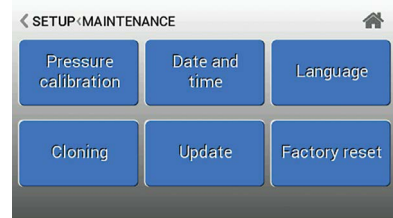

#### 6.1 PRESSURE CALIBRATION

Pressure Calibration is used to ensure accurate and reliable pressure sensing occurs continuously in the room environment. To access pressure calibration from the home screen, press the Settings icon in the top right corner. From the Maintenance menu, select Pressure Calibration.

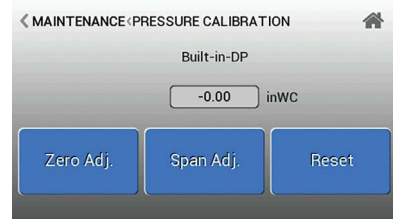

Depending on connection, the unit will display the live value of the room pressure being sensed at the time of menu access. Zero Adjustment can be used for either an on-board sensor (DP) or external sensor (UI2 and UI3). To access the on-board sensor, remove the RSMC display from the wall surface and remove the pressure tubes from the "+" (HIGH) and "-" (LOW) side of the sensor on the back of the unit. Let both the "+" and "-" ports open/unblocked and press the Apply the Zero Function button. The same can be done for external pressure transmitters at their location.

### 6.1 PRESSURE CALIBRATION (Continued)

Span Adjustment is used for calibration of the internal or external pressure transducer sensors and testing operation of hardware circuitry. Calibration should only be performed by qualified personnel, using a pressure calibrator.

1. Select the sensor (DP, UI2, UI3) desired for recalibration. The indicated pressure will be shown.
2. Disconnect the two pressure tubes from the unit.
3. Connect tubing from the calibrator to the “-” LOW and “+” HIGH ports identified on the back of the RSMC unit.
4. Apply full range pressure. For example  $\pm 0.5$  in w.c. range use +0.5 in w.c. pressure.
5. When pressure reaches full range, press Span Adjustment.
6. The output at full range must be within 10% of the factory calibration to allow readjustment.

Selecting Reset permits the user to discard any changes that may have been done unintentionally, leaving the unit as it was before any Zero Adjustments or Span Adjustment modifications.

### 6.2 DATE AND TIME

The Date and Time allows the unit date and time to be manually set, or sourced via BACnet. The display of the date and time on the home screen can be customized. Since there is no internal battery, if the power is lost, the date and time will be erased. If the device is connected by Modbus® or BACnet, the values will be restored via the network. To access Date and Time from the home screen, press the Settings icon in the top right corner. From the Maintenance menu, select Date and Time.

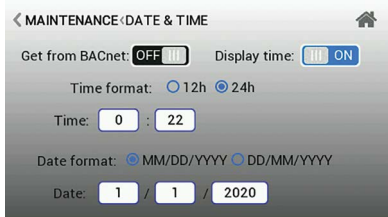

### 6.3 DUPLICATE CLONING

To access Duplicate Cloning from the home screen, press the Settings icon in the top right corner. From the Maintenance menu, select Duplicate Cloning. The Copy to USB function is used to capture a RSMC configuration onto a USB thumb drive. This function is useful to store configurations on a personal computer, where a controlled inventory of one or more units can be maintained. In the event that a RSMC password has to be reset or the unit needs replacement, the proper configuration file can be retrieved and loaded. The Copy from USB function is used to copy a RSMC configuration from a USB thumb drive to another RSMC unit. A RSMC configuration previously captured can then be “cloned,” or copied to other units to reduce setup time. Once copied, the “cloned” unit then only needs room-specific parameters setup, such as room name, IP address, and other unique parameters.

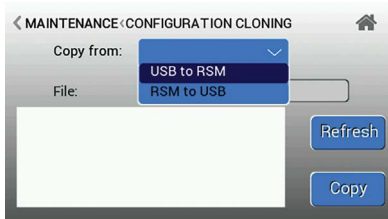
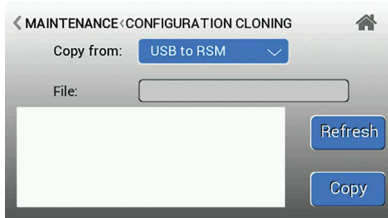

### 6.4 RESET TO FACTORY DEFAULTS

The function Reset to Factory Default is used in the event a RSMC unit must be put into a known state for either service or a configuration reload. To access Reset from the home screen, press the Settings icon in the top right corner. From the Maintenance menu, select Reset.

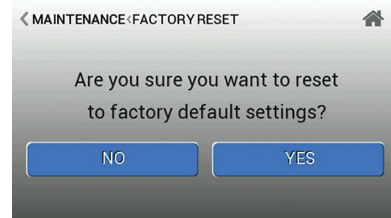

A factory reset may help establish a baseline of original functionality from which to build the specific configuration for a given application. New configurations can then be added by either touchscreen entry, Copy from USB, or over the BACnet network. Selecting NO will cause the RSMC unit to remain in its current state of configuration. Selecting YES will cause the RSMC to erase all configuration information and restore the RSMC to its original factory configuration. Once YES is selected, this function cannot be reversed or undone.

An alternative way to reset the unit to factory default settings is to insert a paperclip and press and hold the button located on the back of unit above terminal block pins 4 and 5. The connector for the second terminal block may need to be removed for easier access. Resetting with the button on the back of the unit will also clear all passwords established. This resetting method should only be used if the password(s) are forgotten or lost.

### 6.5 FIRMWARE UPDATE

To update the device firmware, a USB-C to USB-A drive will be required. Download the updated device firmware onto the USB drive via a laptop or desktop computer. Do not change the name of the firmware file, it will end in “.kld”. Once the firmware file is on the USB-C to USB-A drive, insert the USB-C connection into the back side of the RSMC unit while it’s powered off. Power on the RSMC with 24 VAC/DC with the USB drive plugged in. Wait for the device to power on completely. The firmware will be updated automatically. Once the device has successfully powered on and shows the homescreen, power off the device and remove the USB drive from the RSMC.

### 6.6 UNIT INFORMATION

The Unit Information menu displays the model number, serial number, calibration date, and firmware version. To access the unit information menu, press the Settings icon in the top right corner of the home screen and select the ‘Unit Information’ button.

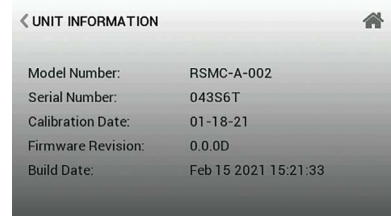

### MAINTENANCE/REPAIR

Upon final installation of the Series RSMC, no routine maintenance is required. The Series RSMC is not field serviceable and is not possible to repair the unit. Field repair should not be attempted and may void warranty. Do not dispose of as unsorted domestic or municipal waste. Consult retailer or local authorities for recycling information.



This symbol indicates waste electrical products should not be disposed of with household waste. Please recycle where facilities exist. Check with your Local Authority or retailer for recycling advice.

### WARRANTY/RETURN

Refer to “Terms and Conditions of Sale” in our catalog and on our website. Contact customer service to receive a Return Materials Authorization number before shipping the product back for repair. Be sure to include a brief description of the problem plus any additional application notes.

Modbus® is a registered trademark of Schneider Electric USA, Inc.