

1 YEAR
WARRANTY

**CE UK
CA**

Ω OMEGA™ **User's Guide**



**Shop online
at
omega.com**

e-mail: info@omega.com
**For latest product
manuals:
[www.omega.com/en-
us/pdf-manuals](http://www.omega.com/en-us/pdf-manuals)**

HANI™ Clamp Temperature Sensor

High Accuracy Non-Invasive Clamp Temperature Sensor



omega.com info@omega.com

Omega Engineering, Inc:

800 Connecticut Ave. Suite 5N01, Norwalk, CT 06854, USA

Toll-Free: 1-800-826-6342 (USA & Canada only)

Customer Service: 1-800-622-2378 (USA & Canada only)

Engineering Service: 1-800-872-9436 (USA & Canada only)

Tel: (203) 359-1660

Fax: (203) 359-7700

e-mail: info@omega.com

**Omega Engineering,
Limited:**

1 Omega Drive, Northbank,
Irlam Manchester M44 5BD
United Kingdom

**Omega Engineering,
GmbH:**

Daimlerstrasse 26 75392
Deckenpfronn Germany

Table of Contents

Table of Contents	3
1 Introduction	5
1.1 HANI™ Clamp Temperature Sensor Mounting	6
2 Wiring Diagram	7
2.1 M12 8-Pin Connector	7
2.1.1 4-20 mA Process Signals.....	7
3 4-20 mA Plug and Play	7
4 SYNC Configuration.....	8
4.1 Configuring Inputs.....	8
4.1.1 Calibration	10
4.1.2 Setting Alarms	11
4.2 Configuring Device Settings	12
4.2.1 Transmit Interval	12
4.2.2 Setting/Changing Passwords.....	12
4.3 Data Logging	14
5 4-20mA Loop-Powered Output	15
5.1 Sensor Mapping	15
5.1.1 4-20 mA Outputs Sensor Mapping.....	16
6 Pairing to an Omega Link Gateway.....	17
6.1 Wireless Pairing	17
6.2 Wired Pairing	17
7 Specifications	18
8 Appendix: HANI™ Clamp Temperature Sensor Input Interface	19
8.1 Register Base Addresses	19
8.2 HANI™ Clamp Temperature Sensor Temperature Input Interface.....	19
8.2.1 Sensor Input Descriptor	19
8.2.2 Sensor Temperature Parameters.....	21
8.2.3 Sensor User Calibration Parameters	22
8.2.4 Sensor IPSO Definition	22
8.3 DIO Interface.....	24
8.3.1 DIO Descriptor.....	24
8.3.2 DIO IPSO Definition	26
8.4 Output Configuration Registers.....	27
8.4.1 Scaling Minimum / Maximum Values	27
8.4.2 Output Values	27
8.4.3 Output Names	28
8.5 4-20 mA Output Configuration.....	28
8.5.1 High Range / Low Range	29
8.5.2 System Error.....	29
8.5.3 Output Type	29
8.5.4 Mapping Enabled	29
8.5.5 Output Mapping.....	29
8.5.6 Scaling Minimum/Maximum Values	29
8.5.7 4-20 mA Loop Powered Error.....	29

8.6	Digital Output Configuration.....	30
8.6.1	Rate	30
8.6.2	Output Type	31
8.6.3	Active State	31
8.6.4	Mapping Enabled	31
8.6.5	Output Mapping.....	31

1 Introduction

The Omega Engineering innovative technology for non-invasive temperature sensing delivers the results of an immersion sensor without the costs of installation, damage, replacement, and calibration that occur with an immersion sensor. The HANI™ Clamp Temperature Sensor makes measuring the temperature of a fluid moving through a pipe easier than ever. There is no cutting or welding necessary. Simply clamp the sensor onto the outside of the pipe and start measuring the temperature of the fluid inside the pipe. The HANI™ Clamp Temperature Sensor has accuracy and response times equivalent to state-of-the-art immersion temperature sensors at a fraction of the installation time and total cost.

The HANI™ Clamp Temperature sensor is designed to be used in conjunction with a 4-20 mA connection for plug-and-play analog output, or with an Omega Link Smart Interface to utilize customizable features using Omega's SYNC configuration software through an integrated M12 connector.

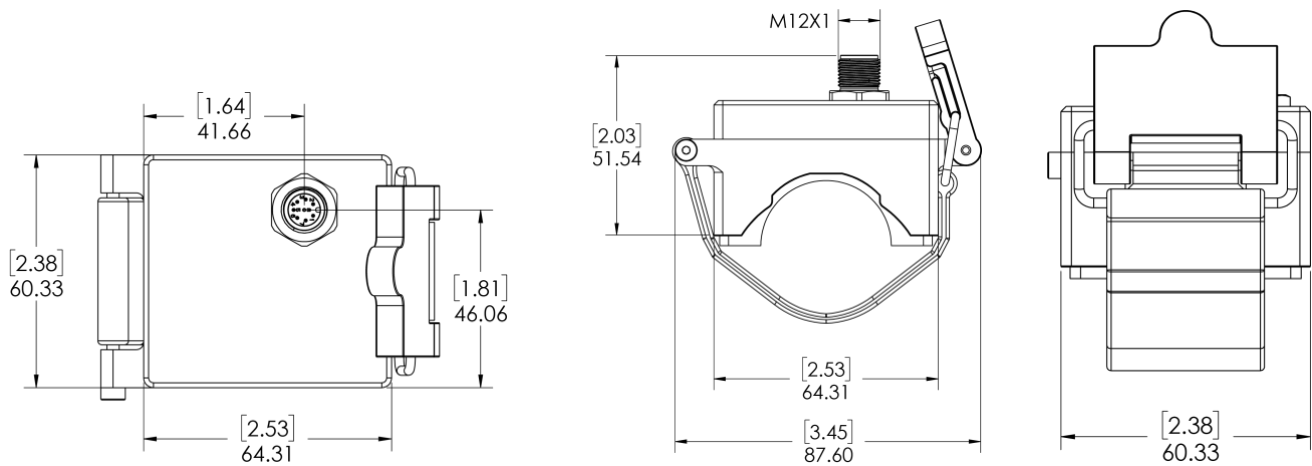

Figure 1: HANI Clamp Temperature Sensor dimensions

1.1 HANI™ Clamp Temperature Sensor Mounting

Setting up a HANI™ Clamp Temperature Sensor in the field is quick and easy. Follow the instructions below:

Step 1: Mount the HANI™ Clamp Temperature Sensor housing on the pipe you will be measuring. Ensure the device is mounted on the side or the underside of a horizontal pipe to ensure you are sensing an area full of liquid.



Figure 2: Mount the HANI™ Sensor

Step 2: Slide the clasp end into the side channels of the cam lever.



Figure 3: Adjust the Clasp and Cam Lever

Step 3: Pull the cam mechanism to tighten the HANI™ Clamp Temperature Sensor securely on the pipe.

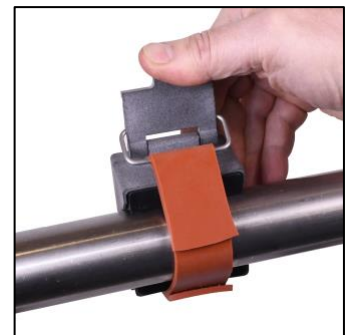

Figure 4: Secure the HANI™ Sensor

Once the cam mechanism is secured on the pipe, the mounting process is Complete.

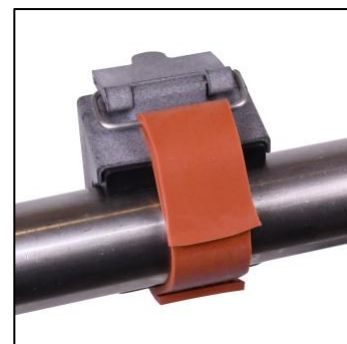

Figure 5: A successfully mounted HANI™ Sensor

2 Wiring Diagram

2.1 M12 8-Pin Connector

The HANI™ Clamp Temperature Sensor connects to a 4-20mA connection or Omega Link Smart Interface through an M12 8-pin female mating connector. The connector supports the required I2C + INTR signal lines and the Smart Probe power signals.

Note: The image below is a view of the open end of the Female Mating M12 8-Pin Connector and *not* the integrated male connector on the HANI™ Clamp Temperature Sensor.

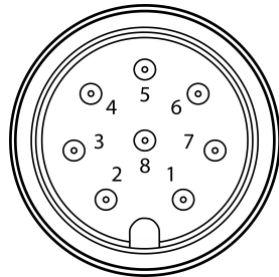

Figure 6: Female Mating M12 8-Pin Connector

	Name	Function	Wiring
Pin 1	Loop -	4-20mA Return	4-20 mA
Pin 2	INTR	Interrupt Signal	Omega Link
Pin 3	SCL	I2C Clock Signal	Omega Link
Pin 4	SDA	I2C Data Signal	Omega Link
Pin 5	Shield	Shield Ground	Omega Link
Pin 6	Loop +	4-20mA Source	4-20 mA
Pin 7	GND	Power Ground	Omega Link
Pin 8	VCC	Power Supply	Omega Link

2.1.1 4-20 mA Process Signals

Refer to the following wiring diagram of the HANI™ Clamp Sensor itself in this section to setup 4-20 mA process signals.

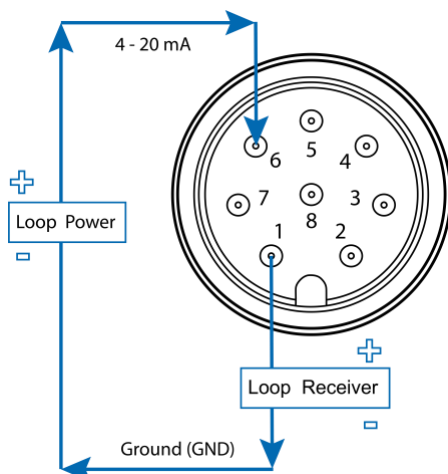

Figure 7: 4-20 mA Process diagram of the Integrated male HANI™ Connector

Name	Description
Loop Power	Provides “excitation” voltage to the sensor, typically 12-24 V _{DC} .
Sensor	Controls the current that flows through the circuit based on the measured value.
Loop Receiver	Converts the 4-20 mA signal to transmit the measured value. This includes PID controllers and programmable logic controllers.

3 4-20 mA Plug and Play

The HANI™ Clamp Temperature Sensor can easily be integrated into your existing analog system in a few steps. To immediately make use of the 4-20 mA plug and play feature, follow these instructions:

Step 1: Mount and strap the HANI™ Clamp Temperature Sensor on the pipe you will be measuring.

Step 2: Attach an 8-pin female M12 connector to your 4-20 mA analog cable (see the HANI™ Clamp Temperature Sensor wiring diagram above – only pins 1 & 6 are needed).

The HANI™ Clamp Temperature Sensor will immediately begin reporting temperature readings.

4 SYNC Configuration

Note **Important:** SYNC configuration is only necessary if you will be changing the following: Pipe Diameter, Pipe Material Type, Pipe Conductivity, or to scale Output Readings. Ensure Omega’s SYNC configuration software is downloaded, setup, and running before continuing. Ensure you have an Omega Link Smart Interface, such as an IF-001 or IF-006, compatible with your HANI™ Clamp Temperature Sensor.

Note **Important:** If the HANI™ Clamp Temperature Sensor is being powered with a 4-20 mA connection and will be configured using SYNC simultaneously, a **USB Isolator** must be used between the user PC and the HANI™ Clamp Temperature Sensor to avoid false readings and potential damage to the unit.

The HANI™ Clamp Temperature Sensor can be configured using Omega’s SYNC configuration software when the HANI™ Clamp Temperature Sensor is connected through an Omega Link Smart Interface to a computer running SYNC. Depending on the Omega Link Smart Interface being used, the connection process may vary slightly. Refer to the User Documentation of the Omega Link Smart Interface you are using.

Once your HANI™ Clamp Temperature Sensor is connected to SYNC, you will immediately see readings appear on the SYNC interface.

4.1 Configuring Inputs

Omega’s SYNC configuration software can be used to configure the HANI™ Clamp Temperature Sensor to suit your application parameters. To configure a HANI™ Clamp Temperature Sensor that is connected to an Omega Link Smart interface using SYNC, navigate to the **Inputs** configuration tab of the SYNC interface.

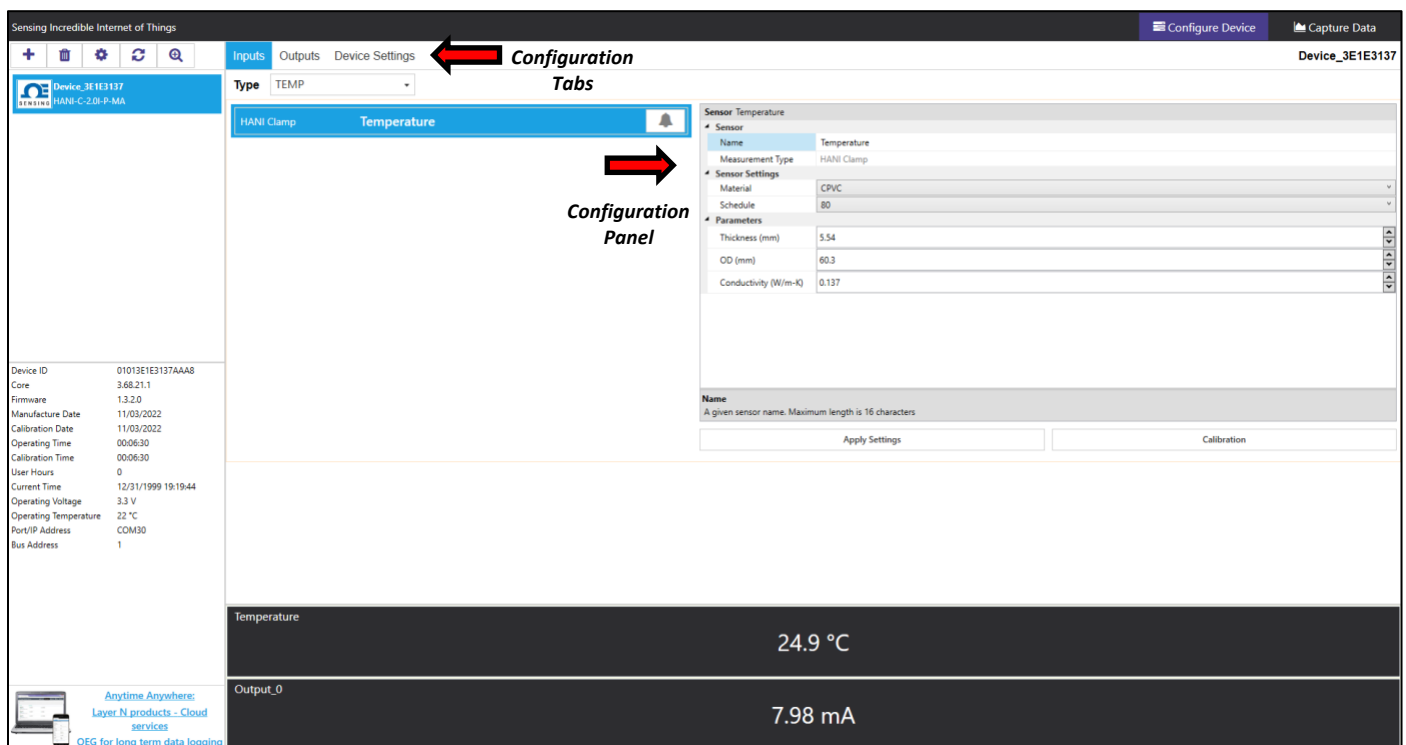

Figure 8: SYNC Configuration Software – HANI™ User Interface

Once in the **Inputs** configuration tab, you will be presented with all the configuration options for the HANI™ Clamp Temperature Sensor Inputs. HANI™ Clamp Temperature Sensors come preconfigured for STAINLESS STEEL pipe materials with standard wall thickness. Sanitary device pipe thickness should not need to be changed. Industrial pipe devices come preconfigured for Schedule 40 (standard) thicknesses. If your pipe material is something other than Stainless Steel and/or has a non-standard pipe thickness, follow the calibration instructions below. To ensure accurate measurements are being reported by the HANI™ Clamp Temperature Sensor, the pipe diameter and thickness should be correctly set.

Step 1: To configure your pipe material, go to the Device Range/Type section of the SYNC user interface and change the Type dropdown to the appropriate metallic pipe material according to the table below:

Type	Material
SS	Stainless Steel
CS	Carbon Steel (1% C)
GS	Galvanized Steel
CU	Copper
BR	Yellow Brass (70%Cu / 30%Zn)
AL	Aluminum
User Specified	Custom – User Scalable Thermal Conductivity Vale for Custom Pipe Type

If your pipe material type is not included in this pre-set list, you may select **User Specified**, in which an additional field will appear for **Conductivity (W/mK)**. Please enter the thermal conductivity of your custom pipe in this additional field. For help in choosing an appropriate value, please contact Omega Engineering for support.

Step 2: To configure your non-standard pipe thickness, go to the **Parameters** section and change the **Pipe Thickness (mm)** to the appropriate wall thickness, entered in *millimeters*.

Step 3: The **Pipe Diameter (mm)** should be pre-configured for the actual pipe outer diameter, based on the SKU that you ordered, but this value can be changed if used on other pipe diameters.

Step 4: Once you have completed configuring the HANI™ Clamp Temperature Sensor inputs, click **Apply Settings** to finalize your changes.

4.1.1 Calibration

The HANI™ Clamp Temperature Sensor has a standard 2-point calibration from the factory, but sometimes, to optimize the accuracy in the user’s application, a **User Calibration** is necessary. A **Single-Point** or **Dual-Point User Calibration** can be performed through Omega’s SYNC configuration software. To perform a successful calibration, the temperature inside the pipe must be known or measurable with an immersion sensor. This immersion sensor temperature value will be used to calibrate the HANI™ Clamp Temperature Sensor based on one of the two procedures below:

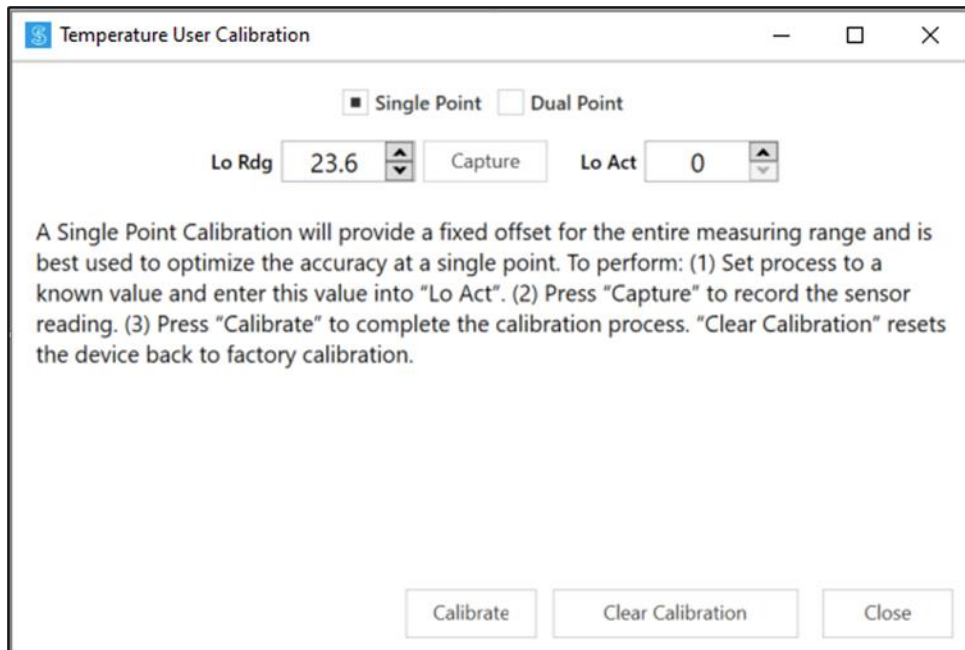

Figure 9: SYNC Configuration Software – Single Point Calibration

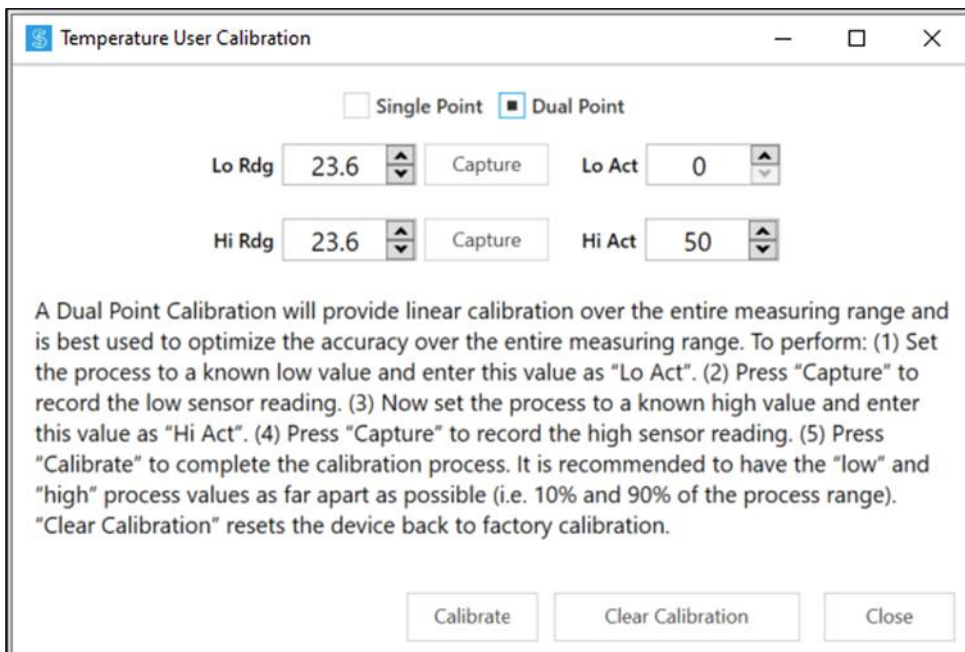



Figure 10: SYNC Configuration Software – Dual Point Calibration

Low Actual:	The real low-temperature process value, as measured by the reference immersion sensor in the process line. For Single-Point Calibrations , you may choose any temperature in the sensor’s process range. For Dual-Point Calibrations , it is recommended to choose a temperature on the low-end of the sensor’s process range (i.e. 20°C).
Low Reading:	The low process value read by the HANI™ Clamp Temperature Sensor.
Capture:	The Capture button will take a live reading from the HANI™ Clamp Temperature Sensor and input the value into the Low Reading or High Reading , as directed.
High Actual:	The real high-temperature process value, as measured by the reference immersion sensor in the process line. Not applicable for Single-Point Calibrations . For Dual-Point Calibrations , it is recommended to choose a temperature on the high-end of the sensor’s process range (i.e. 80°C).
High Reading:	The high process value read by the HANI™ Clamp Temperature Sensor.
Calibrate:	The Calibrate button calculates and calibrates the new slope and offset based on the Readings and Actuals entered above.
Clear Calibration:	This button will clear the previously entered User Calibration values and as a result, returns the HANI™ Clamp Temperature Sensor to its factory calibration.

4.1.2 Setting Alarms

Alarms are set by clicking the  icon in SYNC on the highlighted input signal found in the **Inputs** configuration tab.



Note: Alarm Outputs are only available on Digital Output models currently; analog output products do not support alarm outputs at this time but can still transmit notifications to the Omega Link Cloud.

Figure 11: SYNC Configuration Software – Setting Alarms

Configure the **Condition** that triggers the alarm by selecting an option from the drop down such as Above or Below. The **Threshold** field(s) will change to display whatever is appropriate for the option chosen such as a High Threshold for an Above condition or a Low Threshold for a Below condition. A **Duration** can be set for the trigger as well where the condition must be met for a certain amount of time before the alarm flags.

Under the **Action** menu, the option to transmit or not transmit a notification can be set. The option to enable an output can also be set. The output chosen must not be currently used in a sensor mapping or ON/OFF control module. The data transmission interval may also be changed upon triggering an alarm, e.g. increase the rate of transmission if an excessive value is detected.

The **Recovery** menu allows the option to clear the alarm after a certain **Duration** once the trigger condition is no longer met. The transmission interval can also be reset to the normal system setting once the alarm is cleared.

To create a new alarm, click the plus icon  and a new alarm will be added. To remove an alarm once it is created, select the alarm in question on the left side of the alarm panel and click the delete icon .

4.2 Configuring Device Settings

Omega’s SYNC configuration software can be used to configure the device settings of your HANI™ Clamp Temperature Sensor. To configure your device settings, navigate to the **Device Settings** configuration tab of the SYNC interface.

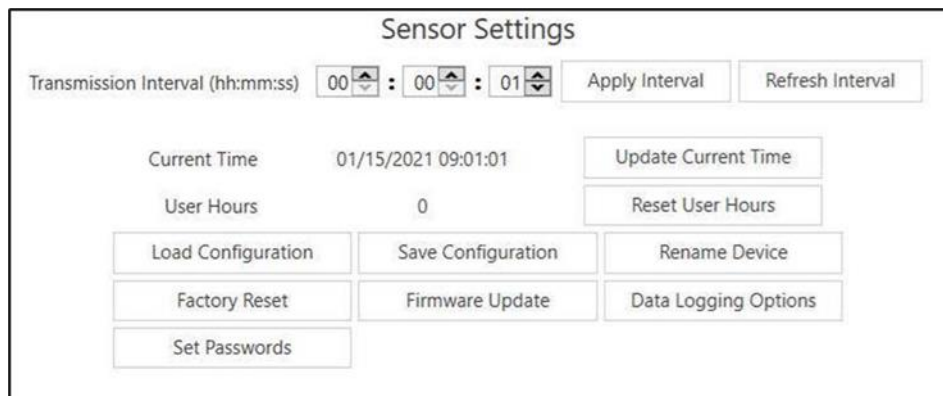

Figure 12: SYNC Configuration Software – Sensor Settings

4.2.1 Transmit Interval

The transmit interval can be adjusted by navigating to the Device Settings tab in the SYNC interface and will appear beneath the Sensor Settings section. The Transmit Interval determines the time between readings for the HANI™ Clamp Temperature Sensor. The transmit interval will also be reset to your minimum interval based on your Omega Link Cloud account once your device is paired to the Omega Link Cloud.

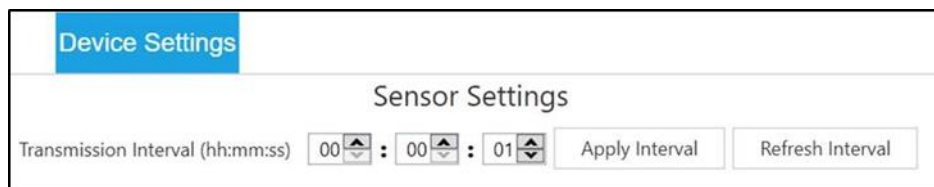

Figure 13: SYNC Configuration Software – Transmit Interval

4.2.2 Setting/Changing Passwords

HANI™ Clamp Temperature Sensor data can be password protected through SYNC. Password protecting your HANI™ Clamp Temperature Sensor prevents data in the device from being extracted without authorization. If your Smart Probe is password-protected, the password must also be stored in the Omega Link Smart Interface so it can transmit data to the Omega Link Cloud. To assign a password to your HANI™ Clamp Temperature Sensor, follow these instructions:

Step 1: Navigate to the *Device Settings* tab in the SYNC interface and click *Set Passwords* under the *Sensor Settings* section.

Step 2: Create a Configuration Password. Upon saving your password, you will be prompted to update the Interface Password as well to ensure your data is transmitted to the Omega Link Cloud.



Figure 14: SYNC Configuration Software – Password Update

Important: If the interface password does not match the configuration password, data from your HANI™ Clamp Temperature Sensor will not be sent to the Omega Link Cloud.

4.2.2.1 Save Password

Password protects the SYNC configurable features of your HANI™ Clamp Temperature Sensor and saves the newly entered password if it is successfully entered and confirmed in both text fields.

4.2.2.2 Clear Password

The Clear Password button removes the password protection from the probe.

4.2.2.3 Login

Click the Login button after entering your device password to access the configurable features.

4.2.2.4 Reset

The Reset Password button deletes the current password on the device. This will cause all logged data to be erased.

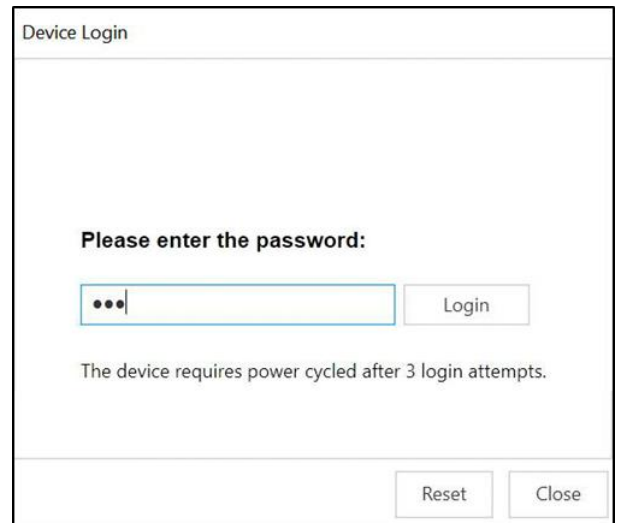

Figure 15: SYNC Configuration Software – Device Login

After 3 failed login attempts, it is required to power cycle the device before trying to login again.

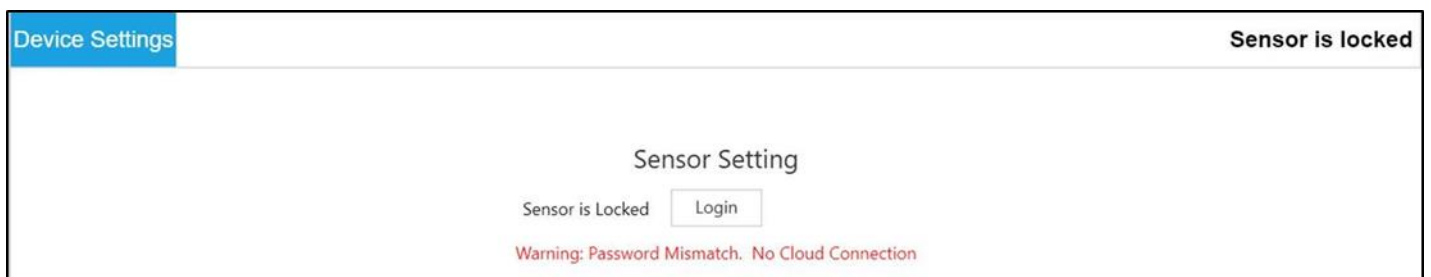

Figure 16: SYNC Configuration Software – Password Locked Device

4.3 Data Logging

The Capture Data interface provides a chart that displays real-time data from your connected HANI™ Clamp Temperature Sensor devices. The Capture Data interface contains the following features:

Extract Data		Extracts data from the device data logger.
Start/Stop Recording		Toggles the real-time data displays to on/off.
Export Data to CSV		Gathers the data that has been recorded or extracted and saves it in a CSV file.

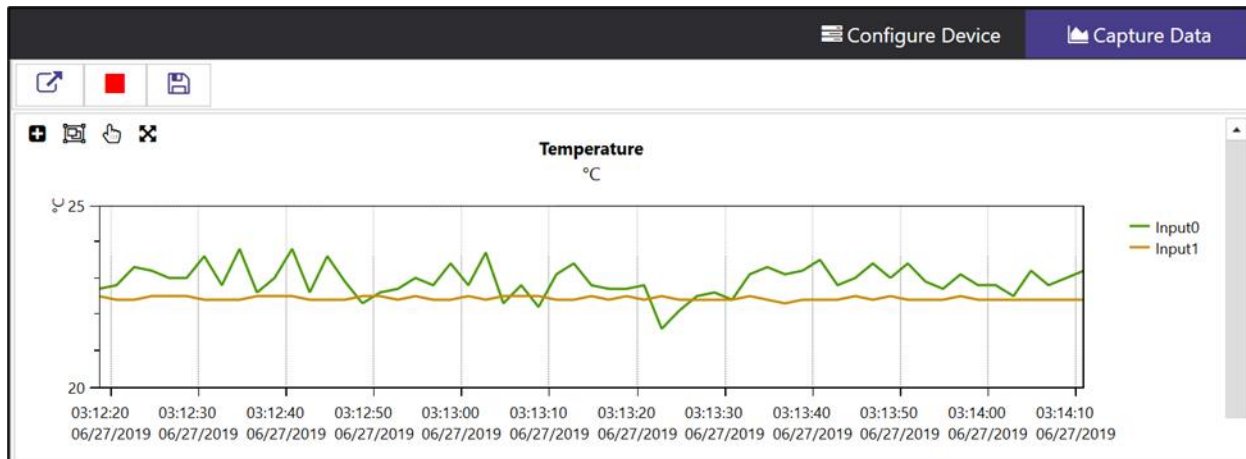

Figure 17: SYNC Configuration Software – Data Logging

Note: Data will be reset if the user switches to the Configure Device interface. The SYNC Data Capture feature is for short-term data logging.

SYNC provides four ways to navigate the Capture Data Interface:

Zoom by Rectangle		Allows the user to left-click and drag the mouse across the graphed data to create a rectangle that will be zoomed in on.
Zoom by Middle Mouse Wheel		Allows the user to zoom in and out of the graphed data using the middle mouse wheel. This only applies to users who have a mouse with the necessary mouse wheel feature.
Pan by Left Mouse Button		Allows the user to left-click and drag on the graphed data to navigate in the direction of the mouse.
Reset		Resets the graphed data to the original position.

5 4-20mA Loop-Powered Output

Devices configured for 4-20 mA Loop Power disable the DIO Inputs and the Digital Outputs. 4-20mA Outputs are widely used due to several advantages' over-voltage outputs:

- Higher noise immunity
- Ability to power the sensing device using the measurement current – provided total power is less than $\sim 3.5\text{mA} \times \text{minimum loop voltage}$
- Automatic wire break detection – if the signal wires are shorted the current will exceed the control system to detect the fault
- Automatic wire short detection – if the signal wires are shorted the current will exceed the specified 20mA, allowing the control system to detect the fault.

The HANI™ Clamp Temperature Sensor 4-20mA Loop Powered device requires a minimum loop voltage of 8.0 volts, allowing the device to be powered using conventional 4-20mA control signals. The factory default configuration connects the measured temperature to the 4-20mA output signal.

5.1 Sensor Mapping

The HANI™ Clamp Temperature Sensor defaults to mapping the measured Temperature to the 4-20mA output. Two user-defined values (*Scaling Minimum, Scaling Maximum*) define the Temperature range that is mapped to the 4-20mA. A measured value outside of the specified range results in an Over-Range or Under-Range condition. A Factory Reset sets the Scaling Minimum to 0°C and the Scaling Maximum to 100°C.

If the Measured Value exceeds the user-defined Scaling Maximum an Over-Range condition exists and the 4-20mA output may be configured to generate either a Fault High (21.5mA) current or a Fault Low (3.8mA) current. The default setting is to generate a Fault High (21.5mA) current.

Similarly, if the measured value is less than the user-defined Scaling Minimum an Under-Range condition exists, and the output may be configured to generate either a Fault High or Fault Low output. The default setting is to generate a Fault Low (3.8mA) current.

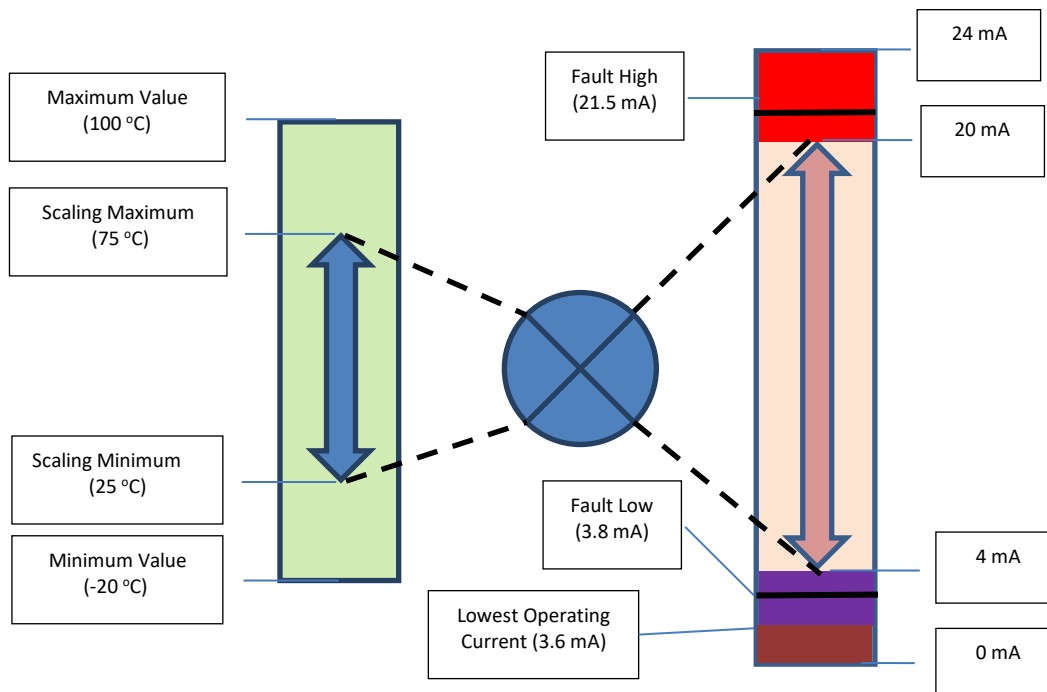

A Loop Error occurs if the applied voltage of the 4-20mA loop drops below the specified minimum loop voltage and the output will be driven to a Low Error level of $\sim 3.8\text{ mA}$.

5.1.1 4-20 mA Outputs Sensor Mapping

The HANI™ Clamp Temperature Sensor offers 4-20 mA output sensor mapping. Navigate to the Outputs Configuration Tab on SYNC.

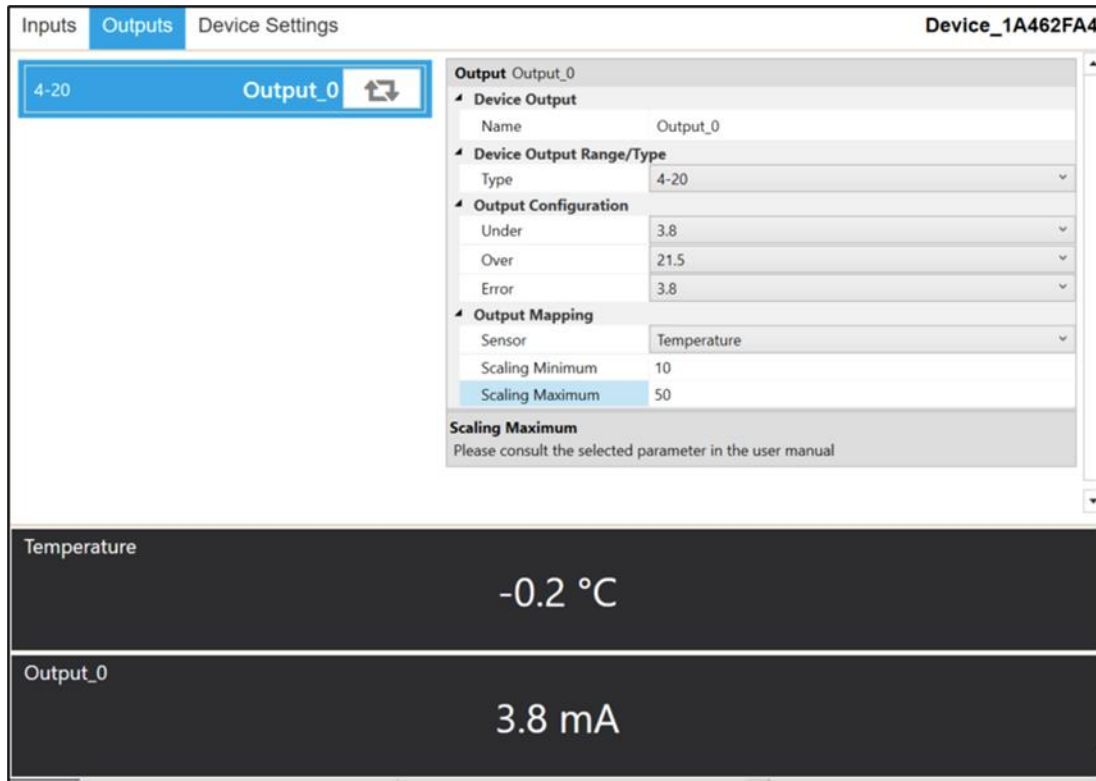

Figure 18: SYNC Configuration Software – 4-20 mA Output Sensor Mapping

Under the **Output Configuration** section, you can set the under/over and error conditions of the 4-20 mA analog output.

- Under:** Any temperature value below the Scaling Minimum will generate an Under fault value.
- Over:** Any temperature value above the Scaling Maximum will generate an Over fault value.

Under the Output Mapping section, you can set the desired 4-20 mA analog output scaling range. The HANI Clamp Temperature Sensor comes standard with a 0-100°C temperature scaling range.

- Scaling Minimum:** Set the Scaling Minimum Temperature value that will result in a 4 mA output. In this example, a temperature of 10°C will result in a 4 mA analog output.
- Scaling Maximum:** Set the Scaling Maximum Temperature value that will result in a 20 mA output. In this example, a temperature of 50°C will result in a 20 mA analog output.

6 Pairing to an Omega Link Gateway

Refer to either the Wireless Pairing or Wired Pairing instructions to pair a HANI™ Clamp Temperature Sensor to an Omega Link Gateway. Before continuing to the pairing instructions, ensure the following prerequisites are met:

- Ensure that the Omega Link Gateway has been properly setup, powered on, and is in close physical proximity.
- (For Wired pairing) Ensure the user has access to a PC and the internal Gateway UI (refer to the Omega Link Gateway manual for instructions on how to access the internal Gateway UI).

6.1 Wireless Pairing

Pairing a wireless Smart Interface (IF-006) and attached HANI™ Clamp Temperature Sensor is made easy with a one-button pairing system between the IF-006 and the Omega Link Gateway.

Step 1: When the HANI™ Clamp Temperature Sensor and relevant accessories have been securely connected to the IF-006, push the pairing button once on the IF-006. The LED status indicator will blink green indicating the device is in Pairing Mode.

Step 2: Quickly push the pairing button on the Omega Link Gateway. The LED on the Gateway will blink green indicating the Gateway is in Pairing Mode.

When the IF-006 has been successfully paired to the Omega Link Gateway, the LED will stop blinking on both devices. Readings for the newly added sensor will then appear on the Omega Link Cloud or Omega Enterprise Gateway interface associated with the registered Gateway.

6.2 Wired Pairing

A wired HANI™ Clamp Temperature Sensor connected directly to an Omega Link Gateway with an IF-001 cable will need to be added to the Gateway Internal User Interface. See the Omega Link Gateway User's Manual for more information. The **Connected Devices** tab is the default page shown once the user has signed in to the internal gateway UI. From here, devices can be added to the gateway to have them appear in a registered Omega Link Cloud or Omega Enterprise Gateway account.

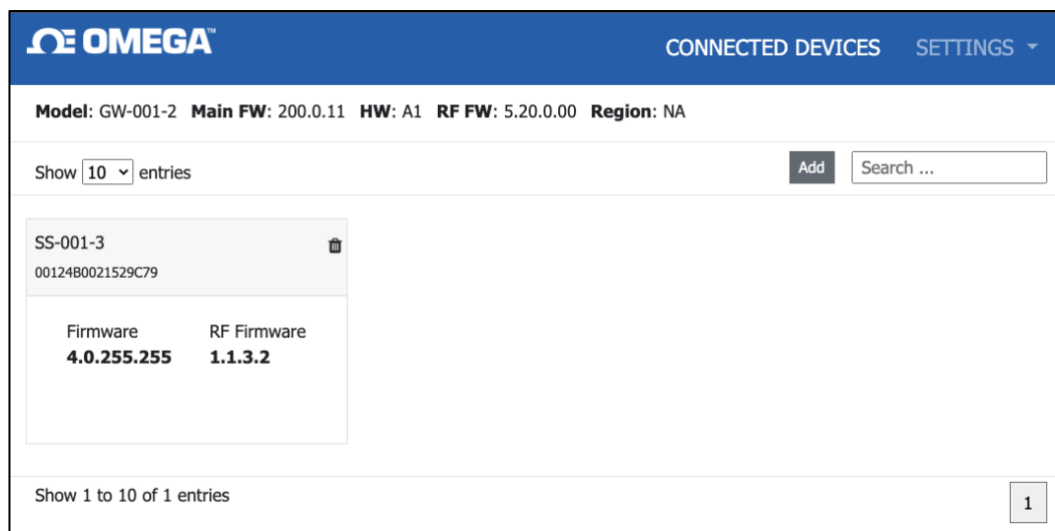



Figure 19: Gateway Internal User Interface

To add a device to your gateway from the internal gateway web UI, begin by clicking the  button at the top right of the web page. Fill out the **Add Device** menu with the parameters of the Smart Probe connection.

7 Specifications

INPUT POWER

Voltage: 8V_{DC} – 28 V_{DC} (Loop Powered)

Max Loop Resistance: $R_{max} (\Omega) = (V_{supply} - 8V)/0.024 A$

ANALOG OUTPUT

Current: 4-20 mA

PROCESS PARAMETERS

Process Medium: Water, water-based fluids (others upon request)

Pipe Materials: Metal Pipes (other upon request)

Pipe Outer Diameters:

Sanitary: 1.5", 2", 2.5", 3", 4"

Industrial: 1", 2", 2.5", 3", 4" nominal

(Others upon request)

Process Temperature Range: -20 to 100°C liquid, user scalable analog output

PERFORMANCE

Accuracy with Fluid Flowing:

Sanitary: ±0.5°C with fluid flowing

Industrial: ±1.0°C from factory and improved accuracy to ±0.5°C possible with in-situation 1 or 2-point calibration

Response Time (τ_{63}): 5 seconds

Response Time (τ_{90}): 10 seconds

ENVIRONMENTAL

Ambient Operating Temperature: 0 to 40°C (32 to 104°F)

Rating: IP67 when mated

MECHANICAL

Dimensions: 60.3mm W x 64.31mm L x 51.54mm H (2.38" W x 2.53" L x 2.03" H)

Materials: PA12, silicone rubber, nickel-plated brass, stainless steel

GENERAL

Agency Approvals: CE UKCA

8 Appendix: HANI™ Clamp Temperature Sensor Input Interface

8.1 Register Base Addresses

Smart Probe devices share a common platform architecture that provides extensive monitoring and control capabilities through a set of platform generic registers. These registers may be accessed using I2C based commands directly to the Smart Probe devices or through a set of Modbus-based registers when using Omega Interface devices.

When powered on or after a device reset each Smart Sensor-based device will enumerate 1 or more sensor instances which are described by the device-specific Sensor Descriptors which include configuration options, measurement type, and units of measure for the corresponding sensor values. Additional sensor information is provided in sensor-specific IPSO object descriptions which include extended measurement type, precision and tracking of minimum/maximum readings.

Each enumerated Sensor has a Descriptor Base address location and a Sensor IPSO / Configuration structure address location based on the sensor mix selected.

Sensor	Descriptor Base	IPSO/Configuration	Enumerated Sensor Mix	
			Digital Output	4-20 mA
0	0x0060 (0xf030)	0x08a8 (0xf454)	Clamp-on Temperature	
1	0x0068 (0xf034)	0x09a8 (0xf4d4)	DIO	
2	0x0070 (0xf038)	0x0aa8 (0xf554)		
3	0x0078 (0xf03c)	0x0ba8 (0xf5d4)		

8.2 HANI™ Clamp Temperature Sensor Temperature Input Interface

The HANI™ Clamp Temperature Sensor Input interface provides a reading of the calculated temperature based on the measured heat flux and temperature values.



Note: The HANI™ Clamp Temperature Sensor products will use a predefined configuration but will require some customization based on the specific installation. Configuration options will be made available to the end-user.

8.2.1 Sensor Input Descriptor

Offset	Name	Value	Description
0x00	Measurement Type	0x37	Temperature (°C)
0x01	Data Type/Format	0x06	Float
0x02	Configuration	0x4?	Determines Material Type
0x03	Sensor Device	0x??	Determines connection type
0x04..0x08	UOMR	“°C”	Units of measure

8.2.1.1 Sensor Measurement Type

The temperature interface provides a measurement of Temperature in °C.

Sensor Type	SI Derived Units	Measurement
0x37	°C	Temperature

8.2.1.2 Sensor Input Data Type/Format

The HANI™ Clamp Temperature Sensor supports extended configuration and provides factory calibration. All data values are returned as 32-bit floating-point values.

HANI™ Clamp Temperature Sensor Input Data Type/Format							
7	6	5	4	3	2	1	0
Smart Sensor	Writeable	Factory Calibrate	Reserved	Data Type			
0	0	0	0	0x06 == FLOAT			

8.2.1.2.1 Data Type

The 4-bit Data Type field determines the type of data of the specific sensor.

8.2.1.2.2 Factory Calibrate

Factory calibration is available for the HANI™ Clamp Temperature Sensor process inputs. Clearing this bit will disable the factory calibration values.

8.2.1.2.3 Writeable

The writeable bit is cleared, indicating that the sensor values may not be overwritten.

8.2.1.3 Sensor Configuration Byte

HANI™ Clamp Temperature Sensor Configuration Byte							
7	6	5	4	3	2	1	0
Available	Assigned	Apply Scaling	Lock	Sensor Range / Type			
0	*	?	?	Material (see below)			

8.2.1.3.1 Sensor Range / Type

The Range / Type field determines the type of pipe material, which determines the thermal conductivity.

If **User Specified** is selected the conductivity may be selected as a *sensor parameter* (see below).

Range / Type	Material	DESCRIPTION	Conductivity (W/m-K)
0x00	User Specified	--	4.0
0x01	SS	Stainless Steel	13
0x02	CS	Carbon Steel	40
0x03	GS	Galvanized Steel	40
0x04	CU	Copper	401
0x05	BR	Brass	111
0x06	AL	Aluminum	236
0x07			
0x08			
0x09			
0x0a			
0x0b			
0x0c			
0x0d			
0x0e			
0x0f			

8.2.1.3.2 Lock

If set, the user-specified units of measure string (4 character maximum) will be used in place of the

default units of measure.

8.2.1.3.3 Apply Scaling

If set, the user-defined Offset and Gain values will be used to adjust the sensor reading:

$$\text{Result} = (\text{Raw Reading} * \text{Gain}) + \text{Offset}$$

8.2.1.3.4 Assigned

The Assigned bit will always read as 0.

8.2.1.3.5 Available

The Available bit will always read as 0.

8.2.1.4 Sensor Device Byte

The HANI™ Clamp Temperature Sensor device byte is not used.

8.2.2 Sensor Temperature Parameters

The HANI™ Clamp Temperature Sensor provides 3 Sensor Parameters that may be updated based on the specific installation.

The HANI™ Clamp Temperature Sensor Temperature parameters are accessible when the device is in the **normal operating** mode (see IPSO Trigger Function).

Parameter	I2C Register	Modbus Register	Name	Range	Step Size	Factory Reset	Description
0	0x08c0	0xf460	Diameter	25.4 – 76.2	0.1	38.1	Diameter in mm
1	0x08d0	0xf468	Thickness	1.0 – 10.0	0.1	1.7	Thickness in mm
2	0x08e0	0xf470	Conductivity	0.01-500	0.01	4	Conductivity in W/(m-K)

8.2.2.1 Diameter

The Diameter is used in the calculation of the temperature and is a factor of the specific installation.

8.2.2.2 Thickness

The Thickness is used in the calculation of the temperature and is a factor of the specific installation.

8.2.2.3 Conductivity

The Conductivity is provided in W/m-K and is used in the calculation of the temperature. The Conductivity parameter is only visible if the material selection is **User Specified**.

8.2.3 Sensor User Calibration Parameters

The HANI™ Clamp Temperature Sensor provides a single or dual-point User Calibration.

The HANI™ Clamp Temperature Sensor parameters are accessible when the device is in the **Calibration** mode (see IPSO Trigger Function). The Calibration Value is calculated internally during the User Calibration sequence and is not externally accessible.

Parameter	I2C Register	Modbus Register	Name	Range	Step Size	Factory Reset	Description
0	0x08c0	0xf460	Low Reading	0.0 – 100.0	0.1	0.0	Value being read by HANI™ sensor
1	0x08d0	0xf468	Low Actual	0.0 – 100.0	0.1	0.0	Actual measured value.
2	0x08e0	0xf470	High Reading	0.0 – 100.0	0.1	100.0	Value being read by HANI™ sensor
3	0x08f0	0xf478	High Actual	0.0 – 100.0	0.1	100.0	Actual measured value.

8.2.3.1 Low Reading

The temperature value being read by the HANI sensor.

8.2.3.2 Low Actual

The actual low temperature as measured by an external, independent sensor.

8.2.3.3 High Reading

The temperature value being read by the HANI sensor.

8.2.3.4 High Actual

The actual high temperature as measured by an external, independent sensor.

8.2.4 Sensor IPSO Definition

The HANI™ Clamp Temperature Sensor IPSO definition provides signal range, measured min/max values, IPSO object type information. The Range information is Temperature Type dependent.

Offset	Name	Value	Description
0xa8	Sensor Type	3303	Temperature (°C)
0xaa	Precision	1	Provides reading of xxx.x
0xac	Sensor Trigger	??	(see below)
0xb0	Min Measured	??	Minimum reading since the last reset
0xb4	Max Measured	??	Maximum reading since the last reset
0xb8	Min Range	0	Minimum temperature
0xbc	Max Range	100	Maximum temperature

8.2.4.1 Precision

The measured temperature value is rounded to provide ± 0.1 degree resolution.

8.2.4.2 Sensor Trigger

The Sensor Trigger function is used to reset the IPSO min/max values as well as controlling the Calibration process.

Sensor Trigger							
7	6	5	4	3	2	1	0
0	0	0	0	0	0	0	Reset Min/Max
15	14	13	12	11	10	9	8
0	0	Calibration Reset	Calibration Status	Calibration Mode	Capture High	Capture Low	Calibration Start

Setting the Reset Min/Max bit to 1 will reset the Min/Max values recorded by the IPSO process.

8.2.4.2.1 User Calibration Sequence

User Calibration allows the user to adjust out small errors by providing an offset (single-point calibration) or offset and gain (dual point calibration) to the measured temperature value. The following sequence may be used to set the correction value:

1. Write 0x0800 to the Trigger Function register (Calibration Mode bit set). This forces the device into Calibration Mode and the Sensor Parameter register access is replaced with the Sensor Calibration register access.

Dual Point Calibration

2. Apply a known fluid temperature near the lower end of the expected temperature range and enter it into the Low Actual register (0x08c4 / 0xf462).
3. Record the value being measured by the HANI sensor and enter it into the Low Reading register (0x08c0 / 0xf460). This process can be simplified by writing a value of 0x0a00 to the Trigger Function register which will cause the HANI sensor to capture the current reading and save it as the Low Reading Value.
4. Apply a known fluid temperature near the higher end of the expected temperature range and enter it into the High Actual register (0x08cc / 0xf466).
5. Record the value being measured by the HANI sensor and enter it into the High Reading register (0x08c8 / 0xf464). This process can be simplified by writing a value of 0x0c00 to the Trigger Function register which will cause the HANI sensor to capture the current reading and save it as the High Reading Value.
6. Write 0x0900 to the Trigger Function register (Calibration Mode and Calibration Start). Internally the device will set the Calibration Status bit and calculate the Gain and Offset linearization values. When the calibration calculation is complete the Calibration Status bit is cleared.
7. Write 0x0000 to the Trigger Function register to return the device to the normal operating mode.

Single Point Calibration

8. Apply a known fluid temperature near the center of the expected temperature range and enter it into the Low Actual register (0x08c4 / 0xf462).
9. Record the value being measured by the HANI sensor and enter it into the Low Reading register (0x08c0 / 0xf460). This process can be simplified by writing a value of 0x0a00 to the Trigger Function register which will cause the HANI sensor to capture the current reading and save it as the Low Reading Value.
10. Write the same value from Step 8 into the High Actual register (0x08cc / 0xf466).
11. Write 0x0900 to the Trigger Function register (Calibration Mode and Calibration Start). Internally the device will set the Calibration Status bit and calculate the Offset value. When the calibration calculation is complete the Calibration Status bit is cleared.

Write 0x0000 to the Trigger Function register to return the device to the normal operating mode.

The Correction value may be reset to zero by writing 0x2800 (Calibration Reset and Calibration Mode) to the Trigger register.

8.3 DIO Interface

The Digital output option supports a DIO Interface that provides 2 digital inputs that are hardwired to the Digital outputs. These may be used to detect the state of external switches (output off) or to monitor the state of the outputs.

Note The DIO is not available for units configured with 4-20 mA outputs.

8.3.1 DIO Descriptor

Offset	Name	Value	Description
0x00	Sensor Type	0x18	Digital Type (Bit mapped)
0x01	Data Type/Format	0x46	Configurable, Float type
0x02	Configuration	0x23	Scaling applied, Bits 0 and 1 enabled
0x03	Sensor Device	0x0f	DIN bits enabled / inverted
0x04	UOMR	"DIN"	Units of measure

8.3.1.1 DIO Sensor Type

The interface provides a bit mapped input of the 2 digital signal lines.

Sensor Type	SI Derived Units	Measurement
0x18	DIN	Bit mapped digital inputs

8.3.1.2 DIO Data Type/Format

DIO Data Type/Format							
7	6	5	4	3	2	1	0
Smart Sensor	Writeable	Factory Calibrate	reserved	Data Type			
0	0	0	0	6 == Floating point			

8.3.1.2.1 Data Type

The 4-bit Data Type field determines the type of data of the specific sensor.

8.3.1.2.2 Factory Calibrate

The Factory Calibrate bit is not used for DIO types.

8.3.1.2.3 Writeable

This indicates that the sensor value may be overwritten. Not used on DIO inputs.

8.3.1.3 DIO Input Configuration

DIO Input Configuration							
7	6	5	4	3	2	1	0
Available	Assigned	Apply Scaling	Lock	Sub Channel Selection			
0	0	1	?	0x03 == bits 0 and 1			

8.3.1.3.1 Lock

If set, the user-specified units of measure string (4 character maximum) will be used in place of the default **DIN**.

8.3.1.3.2 Apply Scaling

If set, the user-defined Offset and Gain values will be used to adjust the sensor reading:

$$\text{Result} = (\text{Raw Reading} * \text{Gain}) + \text{Offset}$$

8.3.1.3.3 Assigned

The Assigned bit will always read as 0.

8.3.1.3.4 Available

The Available bit will always read as 0.

8.3.1.4 DIO Device Configuration

The DIO Device Configuration allows enabling each of the 2 input bits and selecting whether the input is active HIGH (reads as 1 when input is not grounded) or active LOW (reads as 1 when input is grounded).

DIO Device Configuration							
7	6	5	4	3	2	1	0
Reserved				DIN 1		DIN 0	
0	0	0	0	ENABLE	INVERT	ENABLE	INVERT
				1	1	1	1

8.3.1.4.1 Invert

If the Invert bit is set the input is active LOW.

8.3.1.4.2 Enable

If the Enable bit is set the input is enabled.

8.3.2 DIO IPSO Definition

The DIO input IPSO definition provides signal range, measured min/max values, IPSO object type information.

Offset	Name	Value	Description
0xa8	Sensor Type	3349	Bit Mapped Digital
0xaa	Precision	0	Provides reading of xxx
0xac	Sensor Trigger	??	Write 0x0001 force reset of min / max
0xb0	Min Measured	??	Minimum reading since the last reset
0xb4	Max Measured	??	Maximum reading since the last reset
0xb8	Min Range	0	Minimum reading
0xbc	Max Range	3	Maximum reading

8.3.2.1 Sensor Trigger Function

The Sensor Trigger function is used to reset the IPSO min/max values as well as controlling the Calibration process.

Sensor Trigger Function							
7	6	5	4	3	2	1	0
0	0	0	0	0	0	0	Reset Min/Max
15	14	13	12	11	10	9	8
0	0	0	0	0	0	0	0

Setting the Reset Min/Max bit to 1 will reset the Min/Max values recorded by the IPSO process.

No User Calibration process is supported on the DIO inputs and all Configuration bits should be written as 0.

8.4 Output Configuration Registers

Outputs share a common structure which consists of 3-fields mapped to a 16-bit unsigned integer, accessible in the Smart Sensor register map.

Output	Name	Modbus Address	I2C Address	Size	Typical Description
0	Output 0 Descriptor	0xf09a	0x0134	uint16	PWM 0 or 4-20 mA
1	Output 1 Descriptor	0xf09b	0x0136	uint16	PWM 1 (see below)
2	Output 2 Descriptor	0xf09c	0x0138	uint16	Phantom (non-configurable)
3	Output 3 Descriptor	0xf09d	0x013a	uint16	Phantom (non-configurable)

Refer to the specific output type for further information.

8.4.1 Scaling Minimum / Maximum Values

When Sensor Mapping is used the user may specify the input signal range through the Scaling Minimum and Scaling Maximum parameters. There is one pair of registers for each of the 4 possible outputs.

Sensor	Name	Modbus Address	I2C Address	Size	Description
0	Output 0 Low Scale	0xf1f0	0x03e0	float	Sets lower input range
	Output 0 High Scale	0xf1f2	0x03e4	float	Sets upper input range
1	Output 1 Low Scale	0xf1f4	0x03e8	float	Sets lower input range
	Output 1 High Scale	0xf1f6	0x03ec	float	Sets upper input range
2	Output 2 Low Scale	0xf1f8	0x03f0	float	Sets lower input range
	Output 2 High Scale	0xf1fa	0x03f4	float	Sets upper input range
3	Output 3 Low Scale	0xf1fc	0x03f8	float	Sets lower input range
	Output 3 High Scale	0xf1fe	0x03fc	float	Sets upper input range

When either the Low Scale or High Scale value changes, an internal calculation is performed to calculate the linear transformation to be applied to the sensor reading.

8.4.2 Output Values

Outputs use *float* values which represent the percentage of full scale. If the output is not mapped, the value written (0 – 100%) is identical to the value that is read back.

If the output is mapped, the scaling values are used to transform the minimum input value to 0% and the maximum input value to 100%.

Output	Name	Modbus Address	I2C Address	Size	Description
0	Output 0 Value	0xf078	0x00f0	float	Percent of full-scale value (0-100%)
1	Output 1 Value	0xf07a	0x00f4	float	Percent of full-scale value (0-100%)
2	Output 2 Value	0xf07c	0x00f8	float	Percent of full-scale value (0-100%)
3	Output 3 Value	0xf07e	0x00fc	float	Percent of full-scale value (0-100%)

8.4.3 Output Names

Each output has a name. The default names for the outputs are **Output_0** through **Output_3**. The default names may be overwritten, such as 'Stack_Lite' or 'Control_Valve'. Names are restricted to 16 characters.

Output	Name	Modbus Address	I2C Address	Size	Description
0	Output 0 Name	0xf078	0xf720	char[16]	Defaults to Output_0
1	Output 1 Name	0xf07a	0xf728	char[16]	Defaults to Output_1
2	Output 2 Name	0xf07c	0xf730	char[16]	Defaults to Output_2
3	Output 3 Name	0xf07e	0xf738	char[16]	Defaults to Output_3

The Output names are retained until a factory reset occurs.

It is strongly recommended that:

1. Spaces within the name should be replaced with the '_' character.
2. All output names on a particular device are unique – if duplicate functions are supported append a '_x' string, where x represents the instance. For example, *Stack_Lite_1* and *Stack_Lite_2* could be used if 2 stack lights are being connected.

8.4.4 Process Temperature

The process fluid temperature can be obtained by reading the below register. The value is returned as a single precision floating point (4 bytes).

Name	Modbus Address	I2C Address	Size	Description
Process Temperature	0xF01E	0x003C	float	Process Temperature

8.5 4-20 mA Output Configuration

4-20 mA outputs are widely used due to several advantages over-voltage outputs:

1. Higher noise immunity
2. Ability to power the sensing device using the measurement current – provided total power is less than ~ 3.5 mA X minimum loop voltage.
3. Automatic wire break detection – if the signal wires break the current drops to 0 mA, allowing the control system to detect the fault.
4. Automatic wire short detection – if the signal wires are shorted the current will exceed the specified 20 mA, allowing the control system to detect the fault.

The HANI™ Clamp Temperature Sensor 4-20 mA Loop Powered device requires a minimum loop voltage of 8.0 volts, allowing the device to be powered using conventional 4-20 mA control signals. The factory default configuration connects the measured temperature to the 4-20 mA output signal.

4-20 mA Output Configuration																	
7	6	5	4		3	2	1		0								
Output Configuration																	
0	0	0	System Error		High Range Error		Low Range Error										
			3.8 mA	0	3.8 mA	0	3.8 mA	0	21.5 mA	1							
			21.5 mA	1	21.5 mA	1	21.5 mA	1	Pass-thru	2 (3)							
			Pass-thru	2 (3)	Pass-thru	2 (3)	Pass-thru	2 (3)	Pass-thru	2 (3)							
15	14	13	12		11	10	9		8								
Output Type																	
Sensor Mapping				Mapping Enabled		Output Type											
No Mapping	0	-	-	Not Enabled	0	<table border="1" style="margin: auto;"> <tr> <td colspan="4" style="text-align: center;">4-20 mA</td> </tr> <tr> <td style="text-align: center;">0</td> <td style="text-align: center;">1</td> <td style="text-align: center;">0</td> <td style="text-align: center;">0</td> </tr> </table>				4-20 mA				0	1	0	0
4-20 mA																	
0	1	0	0														
Sensor 0	1	0	0	Enabled	1												
Sensor 1	1	0	1	Enabled	1												
Sensor 2	1	1	0	Enabled	1												
Sensor 3	1	1	1	Enabled	1												

8.5.1 High Range / Low Range

The High Range and Low Range configuration values determine what 4-20 mA signal is generated if the signal is above or below the specified input range. The pass-thru option indicates that the output signal is not clamped.

If the Measured Value exceeds the user-defined Input Maximum an *Over-Range* condition exists. The 4-20 mA output may be configured to generate a Fault High (21.5 mA) current or a Fault Low (3.8 mA) current when an Over Range condition occurs.

Similarly, if the Measured Value is less than the user-defined Input Minimum an *Under-Range* condition exists, and the output may be configured to generate either a Fault High or Fault Low output.

A Loop Error occurs if the applied voltage of the 4-20 mA loop drops below the specified minimum loop voltage and the output will be driven to a low Error level of ~ 3.5 mA.

8.5.2 System Error

The System Error setting defines whether the output is driven to a low current or high current if an internal system error occurs.

8.5.3 Output Type

The Output Type is fixed as a 4-20 mA output.

8.5.4 Mapping Enabled

If set, the read-only Mapping Enabled bit indicates that the output may be optionally directly mapped to a sensor input. If the Mapping Enabled bit is clear no mapping is supported, and the Sensor Mapping field is ignored.

8.5.5 Output Mapping

The Output Mapping value may select 'no mapping' or Sensor 0 through 3. If no mapping is selected the 4-20 mA output may be directly controlled by writing a value from 0 – 100 % (0 mA to 24 mA) to the internal Output Value. If a Sensor is selected the 4-20 mA output will be scaled to track the measured sensor value between the Scale Low and Scale High range.

If no sensor mapping is in place the output value is determined by the percent activation applied (0 – 100 %). For example, 50% excitation generates an output current of 12 mA, whereas a 75% activation generate an output of $(75 / 100) * 24 \text{ mA} = 18 \text{ mA}$.

8.5.6 Scaling Minimum/Maximum Values

When Sensor Mapping is used with the 4-20mA output, the user may specify the input signal range through the Scaling Minimum and Scaling Maximum parameters.

Name	Modbus Address	I2C Address	Size	Description
Scaling Minimum	0xf1f0	0x03e0	float	Sets lower input range
Scaling Maximum	0xf1f2	0x03e4	float	Sets upper input range

 **Note:** Due to the Loop Power requirements specifying an output value below 15% (3.5 mA) will typically be clamped at 3.6 mA.

8.5.7 4-20 mA Loop Powered Error

A Loop Error occurs if the applied voltage of the 4-20 mA loop drops below the specified minimum loop voltage and the output will be driven to a low Error level of ~ 3.5 mA.

8.6 Digital Output Configuration

The Digital output option provides two output signals which may be configured for ON/OFF, PWM, or SERVO outputs through the Output Configuration registers. The remaining outputs are assigned as phantom devices which are non-configurable.

The highlighted entries show typical default configurations.

Digital Output Configuration																
7			6		5		4		3	2	1	0				
Output Configuration																
			Servo Range		Active State		Rate									
												1.0 – 2.0	0	LOW	0	
			0.5 – 2.5	1	HIGH	1										
												100 Hz	0	0	0	
												10 Hz	0	0	1	
												1 Hz	0	1	0	
												0.1 Hz	0	1	1	
												50 Hz	1	0	0	
33 Hz	1	0						1								
					25 Hz	1	1	0								
					20 Hz	1	1	1								
15			14		13		12		11	10	9	8				
Output Type																
Sensor Mapping				Mapping Enable				Output Type								
No Mapping		0	-	-	Not		0	Null		0	0	0	0			
Sensor 0	1	0	0	Enabled		1	ON/OFF		0	0	0	1				
Sensor 1	1	0	1	Enabled		1	PWM		0	0	1	0				
Sensor 2	1	1	0					Servo		0	0	1	1			
Sensor 3	1	1	1													

8.6.1 Rate

The Rate determines the repetition rate, or frequency, of the Digital Output. For On/Off outputs the rate field is ignored.

8.6.1.1 PWM Rate

The Digital output supports the following PWM frequencies:

PWM Rate	Name	Description
0	100 Hz	PWM signal has constant 100 Hertz frequency (10 msec repetition rate) with 0 – 100 % duty cycle
1	10 Hz	PWM signal has constant 10 Hertz frequency (100 msec repetition rate) with 0 – 100 % duty cycle
2	1 Hz	PWM signal has constant 1 Hertz frequency (1 sec repetition rate) with 0 – 100 % duty cycle
3	0.1 Hz	PWM signal has constant 0.1 Hertz frequency (10 second repetition rate) with 0 – 100 % duty cycle

8.6.1.2 SERVO Rate

Smart Sensor probes support the following SERVO frequencies:

PWM Rate	Name	Description
0	100 Hz	PWM signal has constant 100 Hertz frequency (10 msec repetition rate) with 0 – 100 % duty cycle
4	50 Hz	PWM signal has constant 50 Hertz frequency (20 msec repetition rate) with 0 – 100 % duty cycle

8.6.2 Output Type

Smart Sensor probes support NULL (0), ON/OFF (1), PWM (2) and SERVO (3) outputs. When set to NULL the output signal will be left in a high impedance state. When set to ON/OFF the Rate and Servo Range controls have no effect. When the SERVO type is selected the Duty-Cycle is restricted so the output signal is either 0.5 – 2.5 msec or 1.0 to 2.0 msec based on the Servo Range bit.

8.6.3 Active State

Smart Sensor digital outputs may be configured as Active HIGH or Active LOW. When set to 1 (Active High), the output will be high impedance when active. When set to 0 (Active Low), the output will be low impedance (~ 0.0 volts) when active. The Factory reset value is 0 (Low).

8.6.4 Mapping Enabled

The read-only Mapping Enabled bit indicates that the output may be optionally directly mapped to a sensor input based on the Sensor Mapping field. If the Mapping Enabled bit is clear no mapping is supported, and the Sensor Mapping field is ignored.

8.6.5 Output Mapping

The Output Mapping value may select 'no mapping' or any of Sensor 0..3. If no mapping is selected the output may be directly controlled by writing a value from 0 – 100 % to the internal Output Value. If a Sensor is selected and the hardware supports the mapping the output will track the selected sensor value, scaled by the Output Minimum and Output Maximum values.

If Output Mapping is enabled for PWM outputs the scaling values are used such that a signal input at or below the Scaling Low-value results in a 0% output and a signal input at or above the Scaling High-value results in a 100% PWM duty cycle.

If Output Mapping is enabled for SERVO outputs the scaling values are used such that a signal input at or below the Scaling Low-value results in a minimum (0.5 or 1.0 msec) pulse width and a signal input at or above the Scaling High-value results in a maximum (2.0 or 2.5 msec) pulse width.

WARRANTY/DISCLAIMER

OMEGA ENGINEERING, INC. warrants this unit to be free of defects in materials and workmanship for a period of **13 months** from date of purchase. OMEGA's WARRANTY adds an additional one (1) month grace period to the normal **one (1) year product warranty** to cover handling and shipping time. This ensures that OMEGA's customers receive maximum coverage on each product.

If the unit malfunctions, it must be returned to the factory for evaluation. OMEGA's Customer Service Department will issue an Authorized Return (AR) number immediately upon phone or written request. Upon examination by OMEGA, if the unit is found to be defective, it will be repaired or replaced at no charge. OMEGA's WARRANTY does not apply to defects resulting from any action of the purchaser, including but not limited to mishandling, improper interfacing, operation outside of design limits, improper repair, or unauthorized modification. This WARRANTY is VOID if the unit shows evidence of having been tampered with or shows evidence of having been damaged as a result of excessive corrosion; or current, heat, moisture or vibration; improper specification; misapplication; misuse or other operating conditions outside of OMEGA's control. Components in which wear is not warranted, include but are not limited to contact points, fuses, and triacs.

OMEGA is pleased to offer suggestions on the use of its various products. However, OMEGA neither assumes responsibility for any omissions or errors nor assumes liability for any damages that result from the use of its products in accordance with information provided by OMEGA, either verbal or written. OMEGA warrants only that the parts manufactured by the company will be as specified and free of defects. OMEGA MAKES NO OTHER WARRANTIES OR REPRESENTATIONS OF ANY KIND WHATSOEVER, EXPRESSED OR IMPLIED, EXCEPT THAT OF TITLE, AND ALL IMPLIED WARRANTIES INCLUDING ANY WARRANTY OF MERCHANTABILITY AND FITNESS FOR A PARTICULAR PURPOSE ARE HEREBY DISCLAIMED. LIMITATION OF LIABILITY: The remedies of purchaser set forth herein are exclusive, and the total liability of OMEGA with respect to this order, whether based on contract, warranty, negligence, indemnification, strict liability or otherwise, shall not exceed the purchase price of the component upon which liability is based. In no event shall OMEGA be liable for consequential, incidental or special damages.

CONDITIONS: Equipment sold by OMEGA is not intended to be used, nor shall it be used: (1) as a "Basic Component" under 10 CFR 21 (NRC), used in or with any nuclear installation or activity; or (2) in medical applications or used on humans. Should any Product(s) be used in or with any nuclear installation or activity, medical application, used on humans, or misused in any way, OMEGA assumes no responsibility as set forth in our basic WARRANTY/DISCLAIMER language, and, additionally, purchaser will indemnify OMEGA and hold OMEGA harmless from any liability or damage whatsoever arising out of the use of the Product(s) in such a manner.

RETURN REQUESTS/INQUIRIES

Direct all warranty and repair requests/inquiries to the OMEGA Customer Service Department. BEFORE RETURNING ANY PRODUCT(S) TO OMEGA, PURCHASER MUST OBTAIN AN AUTHORIZED RETURN (AR) NUMBER FROM OMEGA'S CUSTOMER SERVICE DEPARTMENT (IN ORDER TO AVOID PROCESSING DELAYS). The assigned AR number should then be marked on the outside of the return package and on any correspondence.

The purchaser is responsible for shipping charges, freight, insurance and proper packaging to prevent breakage in transit.

FOR **WARRANTY** RETURNS, please have the following information available BEFORE contacting OMEGA:

1. Purchase Order number under which the product was PURCHASED,
2. Model and serial number of the product under warranty, and
3. Repair instructions and/or specific problems relative to the product.

FOR **NON-WARRANTY** REPAIRS, consult OMEGA for current repair charges. Have the following information available BEFORE contacting OMEGA:

1. Purchase Order number to cover the COST of the repair,
2. Model and serial number of the product, and
3. Repair instructions and/or specific problems relative to the product.

OMEGA's policy is to make running changes, not model changes, whenever an improvement is possible. This affords our customers the latest in technology and engineering.

OMEGA is a trademark of OMEGA ENGINEERING, INC.

© Copyright 2019 OMEGA ENGINEERING, INC. All rights reserved. This document may not be copied, photocopied, reproduced, translated, or reduced to any electronic medium or machine-readable form, in whole or in part, without the prior written consent of OMEGA ENGINEERING, INC.

Where Do I Find Everything I Need for Process Measurement and Control? **OMEGA...Of Course!** *Shop online at omega.com*

TEMPERATURE

- Thermocouple, RTD & Thermistor Probes, Connectors, Panels & Assemblies
- Wire: Thermocouple, RTD & Thermistor
- Calibrators & Ice Point References
- Recorders, Controllers & Process Monitors
- Infrared Pyrometers

PRESSURE, STRAIN AND FORCE

- Transducers & Strain Gages
- Load Cells & Pressure Gages
- Displacement Transducers
- Instrumentation & Accessories

FLOW/LEVEL

- Rotameters, Gas Mass Flowmeters & Flow Computers
- Air Velocity Indicators
- Turbine/Paddlewheel Systems
- Totalizers & Batch Controllers

pH/CONDUCTIVITY

- pH Electrodes, Testers & Accessories
- Benchtop/Laboratory Meters
- Controllers, Calibrators, Simulators & Pumps
- Industrial pH & Conductivity Equipment

DATA ACQUISITION

- Communications-Based Acquisition Systems
- Data Logging Systems
- Wireless Sensors, Transmitters, & Receivers
- Signal Conditioners
- Data Acquisition Software

HEATERS

- Heating Cable
- Cartridge & Strip Heaters
- Immersion & Band Heaters
- Flexible Heaters
- Laboratory Heaters

ENVIRONMENTAL MONITORING AND CONTROL

- Metering & Control Instrumentation
- Refractometers
- Pumps & Tubing
- Air, Soil & Water Monitors
- Industrial Water & Wastewater Treatment
- pH, Conductivity & Dissolved Oxygen Instruments