

USER'S GUIDE

LVN-40 & LVN-50 Series

Liquid Level Switch



omega.com | info@omega.com

For latest product manuals:
omega.com/en-us/pdf-manuals

1 YEAR
WARRANTY

CONTACT

Omega Engineering, Inc.

omega.com/contact-us

Toll-Free:

1-800-826-6342 (USA & Canada only)

Customer Service:

1-800-622-2378 (USA & Canada only)

Engineering Service:

1-800-872-9436 (USA & Canada only)

Telephone:

(203) 359-1660

Fax:

(203) 359-7700

Email: info@omega.com

For other locations visit:

omega.com/worldwide

Table of Contents

1. Important Information	4
2. General Description	5
3. Specifications	5
4. Single Station Level Switches with "NPT" Mounting.....	6

1. Important Information

Product must be maintained and installed in strict accordance with the National Electrical Code and Omega Instructions. Failure to observe this warning could result in serious injuries or damages.

Caution

The pressure and temperature limitations shown for the specified level switches must not be exceeded. These pressures and temperatures must take into consideration possible system surge pressures/temperatures and their frequencies.

The liquids used must be compatible with the materials of construction. Specifications of material will be given upon request. Life expectancy of switch contacts varies with applications. Ambient temperature changes do affect switch set points, since specific gravities of liquids vary with temperature.

Level switches have been designed to be shock and vibration resistant; however, shock and vibration should be minimized.

Excessive contaminants in fluid may inhibit float operation and occasional wipe-down may be necessary. Troubleshooting and maintenance of level switches should be in strict compliance with procedures set forth in the troubleshooting and maintenance sections of the technical brochure or an installation, operation, and maintenance bulletin.

Level switches must not be field-repaired.

Physical damage to product may render product unserviceable.

2. General Description

Constructed entirely of 316 SS, the LVN-40 Single Station Level Switch is specifically designed to withstand the effects of a wide range of chemicals. The unit has a maximum operating temperature of 300 °F and can be used to meet many level control applications, including medical and water purification requirements. Its small float displacement permits high accuracy and reliability in shallow tanks and reservoirs.

The LVN-50 Series Level Switches offer superlative performance and dependability under the most severe operating conditions. The sensor incorporates a larger float displacement and all stainless steel construction for consistent level monitoring in liquids pressurized to a maximum 1000 PSIG. Ideal for level sensing in chemical plants and systems, models are available for temperatures up to 300 °F.

These Switches are sealed with potting compound so that the switches will meet or exceed a NEMA-6 rating, making them suitable for submersion with years of worry free operation in moisture-laden environments.

Caution

This instrument must not be subjected to temperatures, pressure, or electrical loads exceeding those appearing on the name plate, and specifications listed.

3. Specifications

Stem Material: 316 SS

Float Material: 316 SS

Operating Temperature: -40 to 149 °C (-40 to 300 °F)

Maximum Pressure Rating: 900 psi to 1000 psi

Mounting: 1/8" NPT for the LVN-40 and LVN-50
1/4" NPT for the LVN-52

Switch: SPST

Switch Actuation: Approximately 1/2 the distance from the end of the stem to mounting, or halfway point of the float travel.

Lead Wires: 20 awg, 24" PVC

Specific Gravity of Float: LVN-40: 0.72
LVN-50: 0.70
LVN-52: 0.64

4. Single Station Level Switches with "NPT" Mounting

Install units vertically in tank top or bottom using Methods 1, 2, 3, or 4 (below).

Note

Units will operate normally inclined up to 30 °.

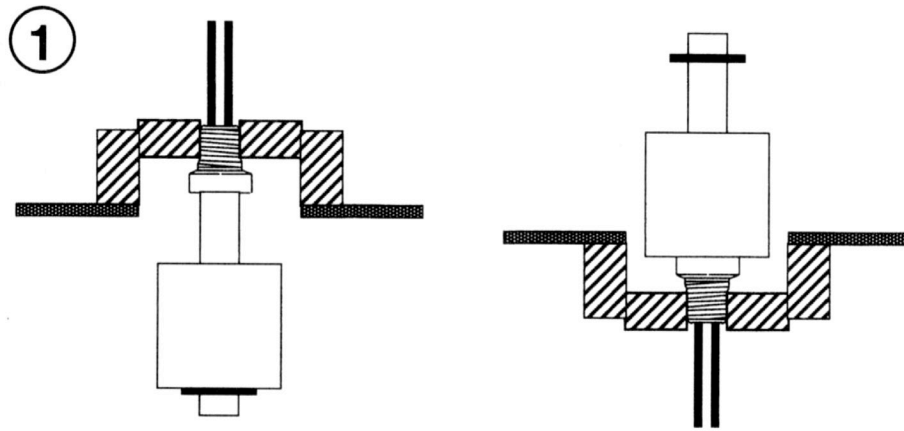

Figure 1

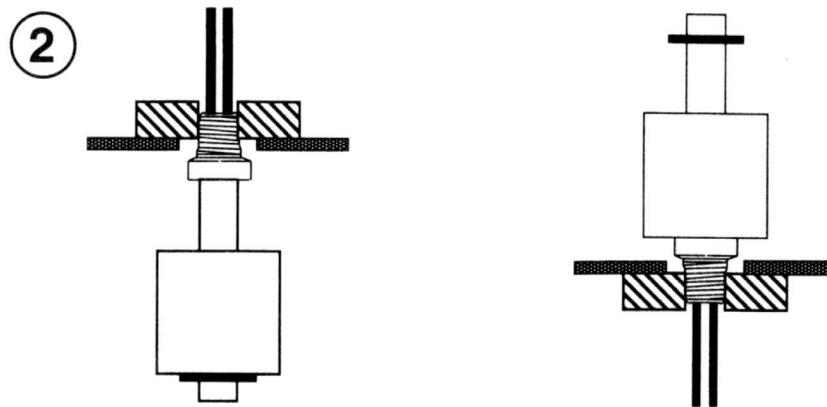
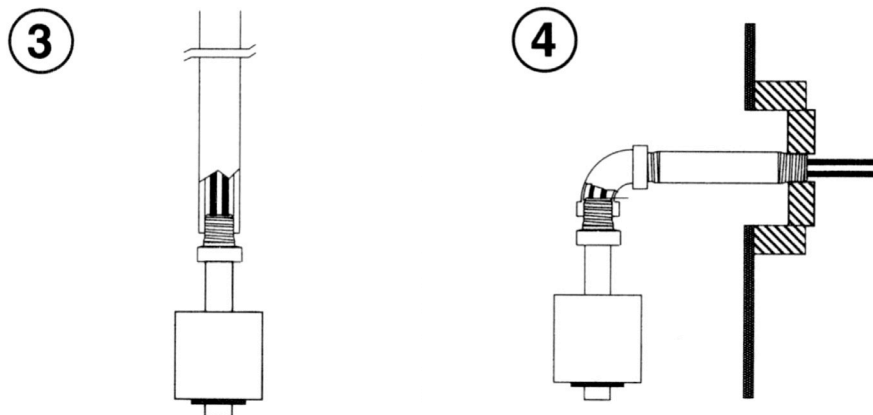

Figure 2



Figures 3 and 4

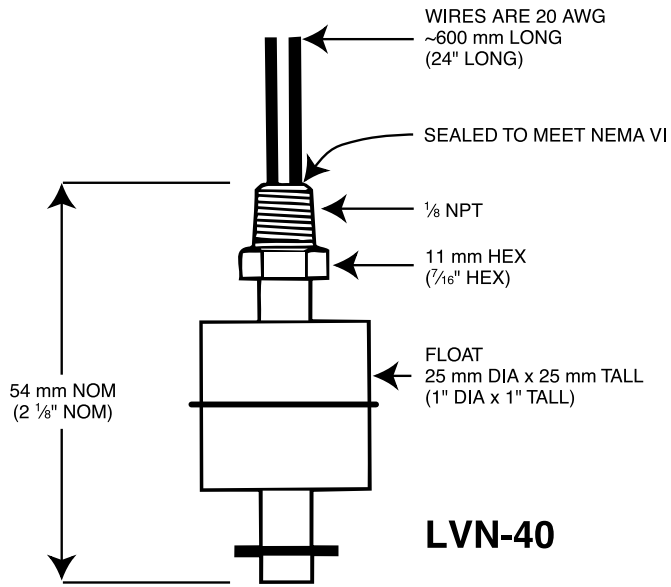
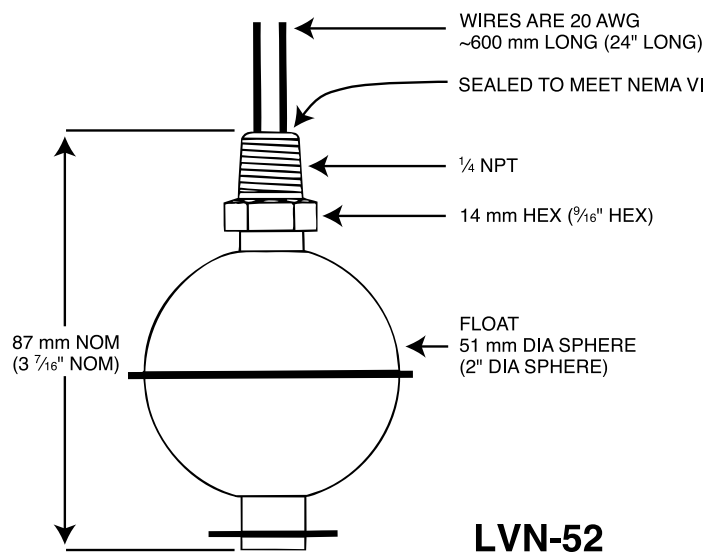
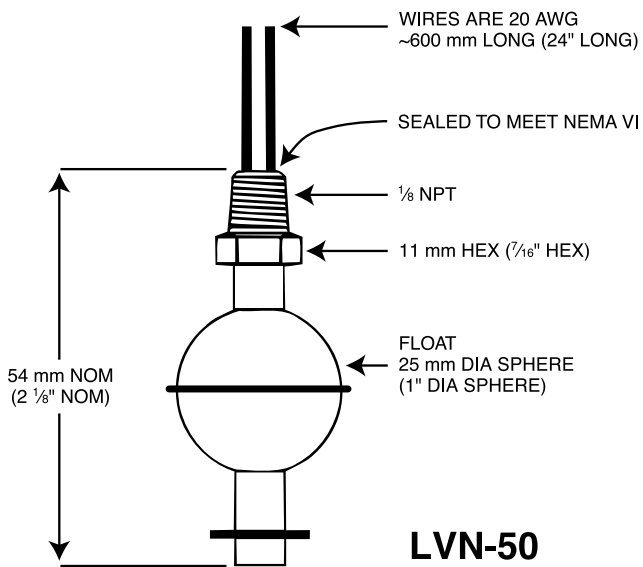

Figure 5



Figures 6 and 7

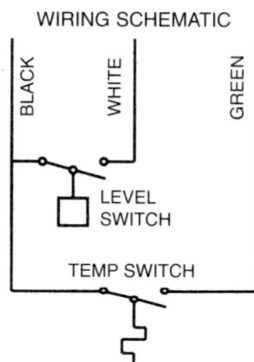

Figure 8

WARRANTY/DISCLAIMER

OMEGA ENGINEERING, INC. warrants this unit to be free of defects in materials and workmanship for a period of **13 months** from date of purchase. OMEGA's WARRANTY adds an additional one (1) month grace period to the normal **one (1) year product warranty** to cover handling and shipping time. This ensures that OMEGA's customers receive maximum coverage on each product.

If the unit malfunctions, it must be returned to the factory for evaluation. OMEGA's Customer Service Department will issue an Authorized Return (AR) number immediately upon phone or written request. Upon examination by OMEGA, if the unit is found to be defective, it will be repaired or replaced at no charge. OMEGA's WARRANTY does not apply to defects resulting from any action of the purchaser, including but not limited to mishandling, improper interfacing, operation outside of design limits, improper repair, or unauthorized modification. This WARRANTY is VOID if the unit shows evidence of having been tampered with or shows evidence of having been damaged as a result of excessive corrosion; or current, heat, moisture or vibration; improper specification; misapplication; misuse or other operating conditions outside of OMEGA's control. Components in which wear is not warranted, include but are not limited to contact points, fuses, and triacs.

OMEGA is pleased to offer suggestions on the use of its various products. However, OMEGA neither assumes responsibility for any omissions or errors nor assumes liability for any damages that result from the use of its products in accordance with information provided by OMEGA, either verbal or written. OMEGA warrants only that the parts manufactured by the company will be as specified and free of defects. OMEGA MAKES NO OTHER WARRANTIES OR REPRESENTATIONS OF ANY KIND WHATSOEVER, EXPRESSED OR IMPLIED, EXCEPT THAT OF TITLE, AND ALL IMPLIED WARRANTIES INCLUDING ANY WARRANTY OF MERCHANTABILITY AND FITNESS FOR A PARTICULAR PURPOSE ARE HEREBY DISCLAIMED. LIMITATION OF LIABILITY: The remedies of purchaser set forth herein are exclusive, and the total liability of OMEGA with respect to this order, whether based on contract, warranty, negligence, indemnification, strict liability or otherwise, shall not exceed the purchase price of the component upon which liability is based. In no event shall OMEGA be liable for consequential, incidental or special damages.

CONDITIONS: Equipment sold by OMEGA is not intended to be used, nor shall it be used: (1) as a "Basic Component" under 10 CFR 21 (NRC), used in or with any nuclear installation or activity; or (2) in medical applications or used on humans. Should any Product(s) be used in or with any nuclear installation or activity, medical application, used on humans, or misused in any way, OMEGA assumes no responsibility as set forth in our basic WARRANTY/DISCLAIMER language, and, additionally, purchaser will indemnify OMEGA and hold OMEGA harmless from any liability or damage whatsoever arising out of the use of the Product(s) in such a manner.

RETURN REQUESTS/INQUIRIES

Direct all warranty and repair requests/inquiries to the OMEGA Customer Service Department. BEFORE RETURNING ANY PRODUCT(S) TO OMEGA, PURCHASER MUST OBTAIN AN AUTHORIZED RETURN (AR) NUMBER FROM OMEGA'S CUSTOMER SERVICE DEPARTMENT (IN ORDER TO AVOID PROCESSING DELAYS). The assigned AR number should then be marked on the outside of the return package and on any correspondence.

The purchaser is responsible for shipping charges, freight, insurance and proper packaging to prevent breakage in transit.

FOR **WARRANTY** RETURNS, please have the following information available BEFORE contacting OMEGA:

1. Purchase Order number under which the product was PURCHASED,
2. Model and serial number of the product under warranty, and
3. Repair instructions and/or specific problems relative to the product.

FOR **NON-WARRANTY** REPAIRS, consult OMEGA for current repair charges. Have the following information available BEFORE contacting OMEGA:

1. Purchase Order number to cover the COST of the repair,
2. Model and serial number of the product, and
3. Repair instructions and/or specific problems relative to the product.

OMEGA's policy is to make running changes, not model changes, whenever an improvement is possible. This affords our customers the latest in technology and engineering.

OMEGA is a trademark of OMEGA ENGINEERING, INC. © Copyright OMEGA ENGINEERING, INC. All rights reserved. This document may not be copied, photocopied, reproduced, translated, or reduced to any electronic medium or machine-readable form, in whole or in part, without the prior written consent of OMEGA ENGINEERING, INC.



omega.com

M-3558/0324

