

1 YEAR
WARRANTY

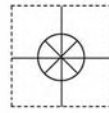

User's Guide



Shop online at

omega.com[®]

Ω OMEGA[®]

omega.com

e-mail: info@omega.com

For latest product manuals:

omegamanual.info

ISO 9001
CERTIFIED
CORPORATE QUALITY

STAMFORD, CT

ISO 9001
CERTIFIED
CORPORATE QUALITY

MANCHESTER, UK

LVCN-131 & LVCN-141 Series Flow Switch Remote Controller



OMEGAnet® Online Service omega.com	Internet e-mail info@omega.com
--	--

Servicing North America:

U.S.A.: ISO 9001 Certified Omega Engineering, Inc., One Omega Drive, P.O. Box 4047
Stamford, CT 06907-0047 USA
Toll Free: 1-800-826-6342 TEL: (203) 359-1660
FAX: (203) 359-7700 e-mail: info@omega.com

Canada: 976 Bergar
Laval (Quebec), Canada H7L 5A1
Toll-Free: 1-800-826-6342 TEL: (514) 856-6928
FAX: (514) 856-6886 e-mail: info@omega.ca

For immediate technical or application assistance:

U.S.A. and Canada: Sales Service: 1-800-826-6342/1-800-TC-OMEGA®
Customer Service: 1-800-622-2378/1-800-622-BEST®
Engineering Service: 1-800-872-9436/1-800-USA-WHEN®

Mexico: En Español: 001 (203) 359-7803 FAX: (001) 203-359-7807
info@omega.com.mx e-mail: espanol@omega.com

Servicing Europe:

Benelux: Managed by the United Kingdom Office
Toll-Free: 0800 099 3344 TEL: +31 20 347 21 21
FAX: +31 20 643 46 43 e-mail: sales@omega.nl

Czech Republic: Frystatska 184
733 01 Karviná, Czech Republic
Toll-Free: 0800-1-66342 TEL: +420-59-6311899
FAX: +420-59-6311114 e-mail: info@omegashop.cz

France: Managed by the United Kingdom Office
Toll-Free: 0800 466 342 TEL: +33 (0) 161 37 29 00
FAX: +33 (0) 130 57 54 27 e-mail: sales@omega.fr

Germany/Austria: Daimlerstrasse 26
D-75392 Deckenpfronn, Germany
Toll-Free: 0 800 6397678 TEL: +49 (0) 7059 9398-0
FAX: +49 (0) 7056 9398-29 e-mail: info@omega.de

United Kingdom: ISO 9001 Certified OMEGA Engineering Ltd.
One Omega Drive, River Bend Technology Centre, Northbank
Irlam, Manchester M44 5BD England
Toll-Free: 0800-488-488 TEL: +44 (0)161 777-6611
FAX: +44 (0)161 777-6622 e-mail: sales@omega.co.uk

It is the policy of OMEGA Engineering, Inc. to comply with all worldwide safety and EMC/EMI regulations that apply. OMEGA is constantly pursuing certification of its products to the European New Approach Directives. OMEGA will add the CE mark to every appropriate device upon certification. The information contained in this document is believed to be correct, but OMEGA accepts no liability for any errors it contains, and reserves the right to alter specifications without notice.
WARNING: These products are not designed for use in, and should not be used for, human applications.

The general-purpose flow controller is offered in two configurations for low-flow pump and process protection. The LVCN-141 Series accepts one flow sensor input and provides one 10A relay for low flow control. The LVCN-131 Series accepts two flow sensor inputs and provides two 10A relays for dual low flow control. Package this flow controller with our liquid or gas flow switch sensors. For field mount installation, add a single or dual controller NEMA box.

Features

- Fail-Safe relay control of pumps, valves or alarms with a 0 to 60 second delay.
- Easy setup with LED indicators for sensor(s), power and relay status.
- 35mm DIN rail mount polypropylene enclosure with removable terminal strips.
- Invert switch changes relay state from NO to NC without rewiring.
- AC powered

Table of Contents

Specifications:	4
Dimensions:.....	4
Safety Precautions:	5
Components:.....	5
Make a Fail-Safe System:	6
Controller Logic:	6
Getting Started:.....	7
Guide to Controls:.....	7
Electrical.....	8
VAC Power Input Wiring:	8
Relay Input Wiring:	8
Changing from 120 to 240 VAC.....	8
Wiring:.....	9
Connecting Switches to Input Terminals:	9
Installation	9
Application Examples.....	10
LED Indication:	10
Low Flow Alarm:.....	11
Dual Flow Alarms:	11
Flow Switch Calibration:	12
Set Points:	12
Appendix	13
Controller Logic.....	13
Troubleshooting.....	13
Relay Latch Logic (LVCN-131 Series only)	14

Supply voltage: 120 / 240 VAC, 50 - 60 Hz.
 Consumption: 5 Watts max.
 Sensor inputs: LVCN-141: (1) flow switch
 LVCN-131: (2) flow switches
 Sensor supply: 24 VDC @ 100 mA
 LED indication: Sensor, power & relay status
 Contact type: LVCN-141: (1) SPDT Relay
 LVCN-131: (2) SPDT Relays
 Contact rating: 250 VAC @ 10A
 Contact output: Selectable NO or NC
 Contact delay: 0 to 60 seconds
 Electronics temp.: F: -40° to 158°
 C: -40° to 70°
 Enclosure rating: 35mm DIN (EN 50 022)
 Enclosure material: PP (U.L. 94 VO)
 Fail safety: Power fail-safe
 Classification: General purpose
 Compliance: CE: EN 61326 EM / EN 61010-1
 Safety

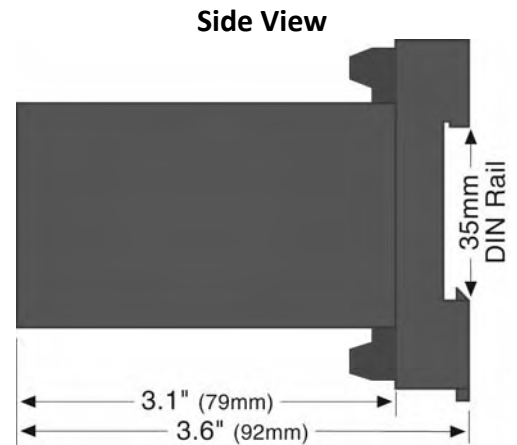
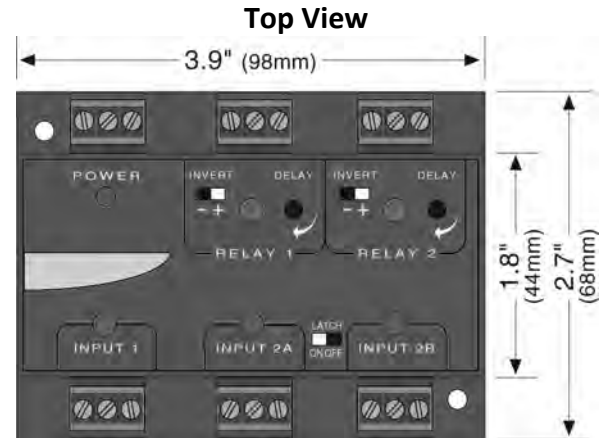

LVCN-141 series faceplate: 1 sensor input, 1 relay output.

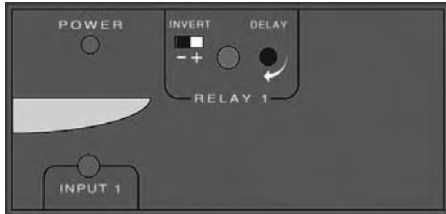

LVCN-131 series faceplate: 2 sensor input, 2 relay outputs.
 One relay for each sensor input.



The LVCN-131 Series can also be used as a level controller with 3 sensor inputs and 2 relay outputs. One relay is latching and the other is a single input relay.

Internal Controller Logic

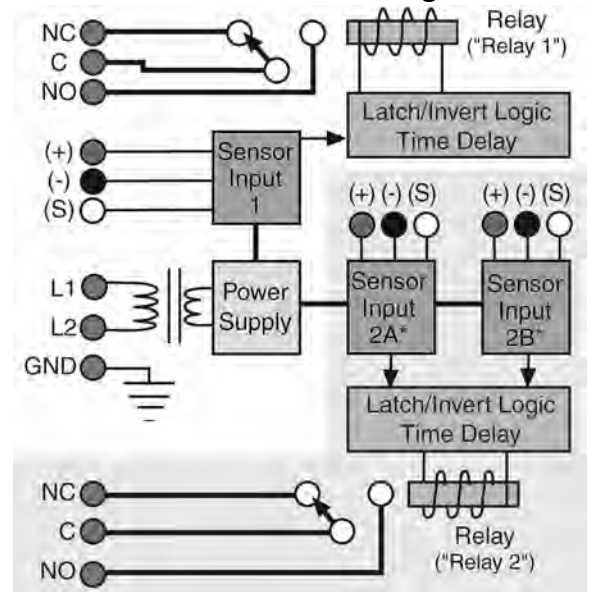

- ⚠ **About This Manual:** PLEASE READ THE ENTIRE MANUAL PRIOR TO INSTALLING OR USING THIS PRODUCT. This manual includes information on three different models of Remote Relay Flow Controllers from OMEGA ENGINEERING: LVCN-141 and LVCN-131 series. Many aspects of installation and use are similar between the three models. Where they differ, the manual will note it. Please refer to the part number on the controller you have purchased as you read.
- ⚠ **User's Responsibility for Safety:** OMEGA ENGINEERING manufactures several models of controller, with different mounting and switching configurations. It is the user's responsibility to select a controller model that is appropriate for the application, install it properly, perform tests of the installed system, and maintain all components.
- ⚠ **Electrical Shock Hazard:** It is possible to contact components on the controller that carry high voltage, causing serious injury or death. All power to the controller and the relay circuit(s) it controls should be turned OFF prior to working on the controller. If it is necessary to make adjustments during powered operation, use extreme caution and use only insulated tools. Making adjustments to powered controllers is not recommended. Wiring should be performed by qualified personnel in accordance with all applicable national, state and local electrical codes.
- ⚠ **Flammable or Explosive Applications:** *The entire LVCN-131/-141 series remote mount flow controllers should not be used with explosive or flammable liquids, which require an intrinsically safe or explosion proof.* If you are unsure of the suitability of a controller for your installation, consult your Omega Engineering representative for further information.
- ⚠ **Install In a Dry Location:** The controller housing is not designed to be immersed. When installed properly, it should be mounted in such a way that it does not normally come into contact with liquid. Refer to an industry reference to ensure that compounds that may splash onto the controller housing will not damage it. Such damage is not covered by the warranty.
- ⚠ **Relay Contact Rating:** The relay is rated for a 10 amp resistive load. Many loads (such as a motor during start-up or incandescent lights) are reactive and may have an inrush current characteristic that may be 10 to 20 times their steady-state load rating. The use of a contact protection circuit may be necessary for your installation if the 10 amp rating does not provide an ample margin for such inrush currents.

Components:

- LVCN-141 - Single Input, Single Relay Output 120 VAC Flow/No-Flow Controller
- LVCN-141-CE - Single Input, Single Relay Output 120 VAC Flow/No-Flow Controller w/CE Compliance
- LVCN-131 - Dual Input, Dual Relay Output 120 VAC Flow/No-Flow Controller
- LVCN-131-CE - Dual Input, Dual Relay Output 120 VAC Flow/No-Flow Controller w/ CE Compliance
- Owner's Manual

Make a Fail-Safe System: Design a fail-safe system that accommodates the possibility of relay or power failure. If power is cut off to the controller, it will de-energize the relay. Make sure that the de-energized state of the relay is the safe state in your process. For example, if controller power is lost, a pump filling a tank will turn off if it is connected to the Normally Open side of the relay.

While the internal relay is reliable, over the course of time relay failure is possible in two modes: under a heavy load the contacts may be “welded” or stuck into the energized position, or corrosion may buildup on a contact so that it will not complete the circuit when it should. In critical applications, redundant backup systems and alarms must be used in addition to the primary system. Such backup systems should use different sensor technologies where possible.

While this manual offers some examples and suggestions to help explain the operation of OMEGA ENGINEERING products, such examples are for information only and are not intended as a complete guide to installing any specific system.

Controller Logic:

LVCN-141 Series: The LVCN-141 series features a single sensor input and a single relay output. Connect the switch input to Input 1 terminal. Wire the device you want to control to Relay 1 terminal.

LVCN-131 Series: The LVCN-131 series features a three (3) sensor inputs and a two (2) relay output. In a majority of applications, the LVCN-131 series will be used as a 2 input / 2 relay output controller. In this case, Sensor Input 1 directly controls Relay 1 and Sensor Input 2A directly controls Relay 2.

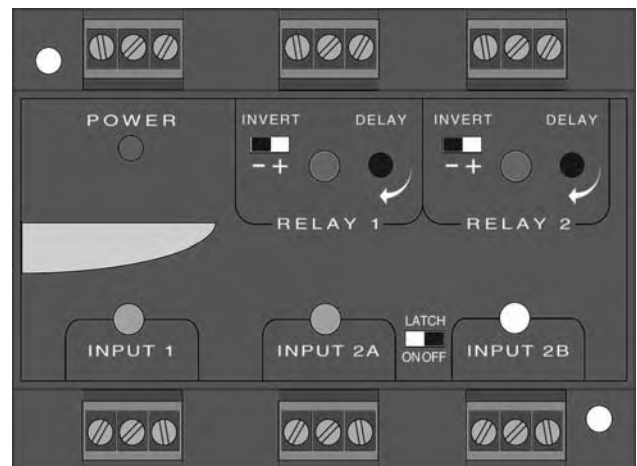
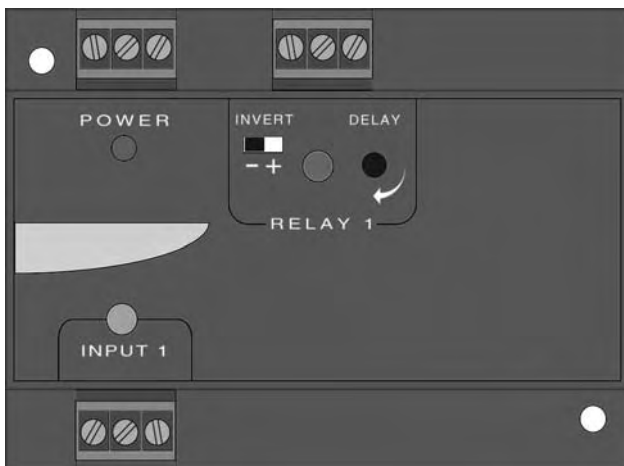

Note: If the latch switch is turned ON, then Relay 2 requires both Inputs 2A & 2B to be in the same state before it will switch. This relay logic is ideal for automatic filling or emptying of tanks and is not used for flow / no-flow applications. If using the LVCN-131 series as a flow / no-flow controller, make sure the Latch switch is turned OFF.

The LVCN-131/-141 Series may be used with almost any Omega Engineering flow with a relay output (FST-200 & FST-300 Series). The relay is a single pole, double throw type; the controlled device can be connected to either the normally open or normally closed side of the relay. A time delay from 0 to 60 seconds can be set before the relay responds to the sensor input. Typical applications for the LVCN-131/-141 Series are pump protection, no-flow indication or chemical injection.

Guide to Controls: Below is a listing and the location of the different components for the controller:

1. **Power indicator:** This green LED lights when AC power is ON.
2. **Relay indicator:** This red LED will light whenever the controller energizes the relay, in response to the proper condition at the sensor input(s) and after the time delay.
3. **AC Power terminals:** Connection of 120 VAC power to the controller. The setting may be changed to 240 VAC if desired. This requires changing internal jumpers; this is covered in the Installation section of the manual. Polarity (neutral and hot) does not matter.
4. **Relay terminals (NC, C, NO):** Connect the device you wish to control (pump, alarm etc.) to these terminals: supply to the COM terminal, and the device to the NO or NC terminal as required. The switched device should be a non-inductive load of not more than 10 amps; for reactive loads the current must be derated or protection circuits used. When the red LED is ON and the relay is in the energized state, the NO terminal will be closed and the NC terminal will be open.
5. **Time delay:** Use potentiometer to set delay from 0.15 to 60 seconds. Delay occurs during switch make and switch break.
6. **Input indicators:** Use these LEDs for indicating Flow or No-Flow status of switch. When switch is Closed, LED will be Amber. When switch is Open, LED will either be OFF. **Note:** Consult the manual for the flow switch to determine exact wiring as well as switch polarity (Open or Closed during Flow).
7. **Invert switch:** This switch reverses the logic of the relay control in response to the switch: conditions that used to energize the relay will now de-energize the relay and vice versa.
8. **Latch switch (LVCN-131 series only):** This switch determines how the relay will be energized in response to either one input (Input 2A) or two inputs (Inputs 2A and 2B). When LATCH is OFF, the relay responds to sensor Input 2A only; when LATCH is ON, the relay will energize or de-energize only when both switches (2A and 2B) are in the same state (both open or both closed). **Note:** In a majority of flow / no-flow applications, the latch will be turned OFF.
9. **Input terminals:** Connect the switch wires to these terminals: (+) is a 24 VDC, 100 mA power supply, (-) is the return path from the sensor and (S) is a powered switch input (14 VDC, 25mA). Consult the flow switch manual for switch polarity (Ex: Open or Closed for Flow) as well as wiring information.

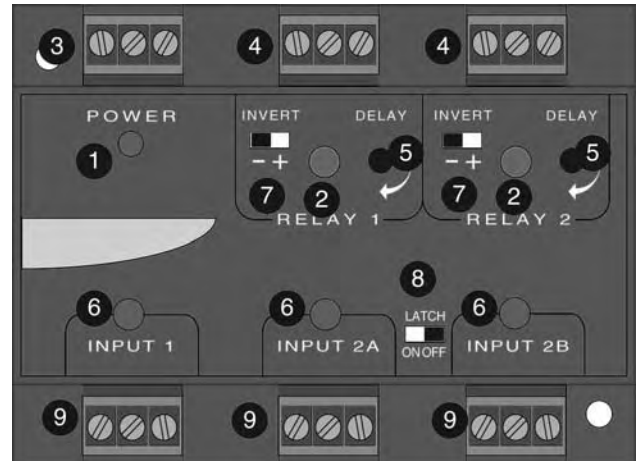

VAC Power Input Wiring: Observe the POWER SUPPLY label on the LVCN-131/-141 series. The label identifies the power requirement (120 or 240 VAC) and the terminal wiring. **Note:** Polarity does not matter with the AC input terminal.

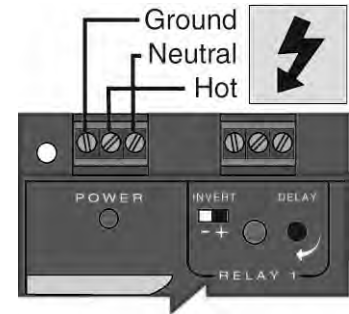
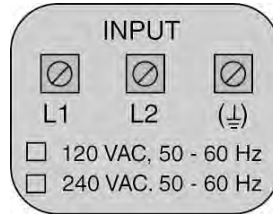
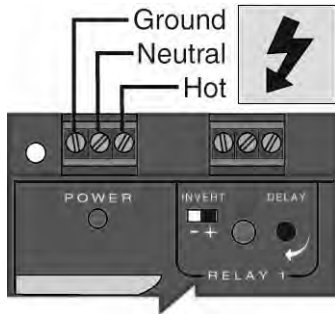

Relay Input Wiring: The relay is a dry-contact single pole, double throw (SPDT) type rated at 250 VAC, 10 Amps. The relay is designed to switch power on and off to a device. There is no active power within the relay contacts alone. Power must be introduced from secondary source or from the power being used by the controller.

Power from a secondary source

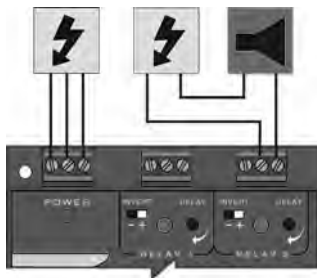

Power from the same source as the controller

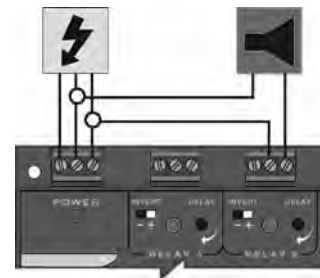

The two terminal Normally Open (NO) and Normally Closed (NC) will be used in different applications. Remember that the "normal" state is when the relay coil is de-energized and the Red relay LED is Off / de-energized. Both terminals share the Common (C) terminal. When relay is de-energized, C to NO will be open and C to NC will be closed. When relay is energized, C to NO will be closed and C to NC will be open. If power is removed to the controller, the relay will return to a de-energized state.

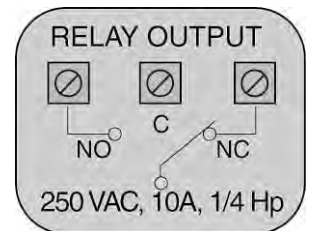

Changing from 120 to 240 VAC:

1. Remove the back panel of the controller and gently slide the printed circuit board from the housing. Use caution when removing the PCB.
2. Located jumpers JW1, JW2 and JW3 on the PCB.
3. To change to 240 VAC, remove jumpers from JW1 and JW2 and place a single jumper across JW3. To change to 120 VAC, remove jumper JW3 and place jumpers across JW1 and JW2.
4. Gently return PCB into housing and replace back panel.

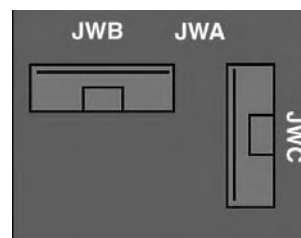

**120 VAC
Configuration**

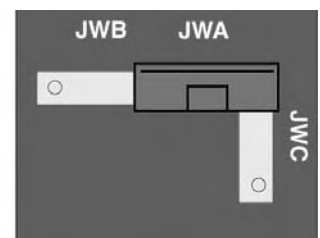

**240 VAC
Configuration**

Connecting flow switches to input terminals: The type of flow switch from Omega Engineering that is compatible with the LVCN-131/-141 series of controller is either the FST-200 or FST-300 series. The flow switches have a relay output and 4 wires as the output (Red, Black, Green and White). See the illustration below to indicate wiring for your switch and the polarity of the switch output. **Note:** the Shield wire will be used only for long cable runs or where excessive electrical noise is present.

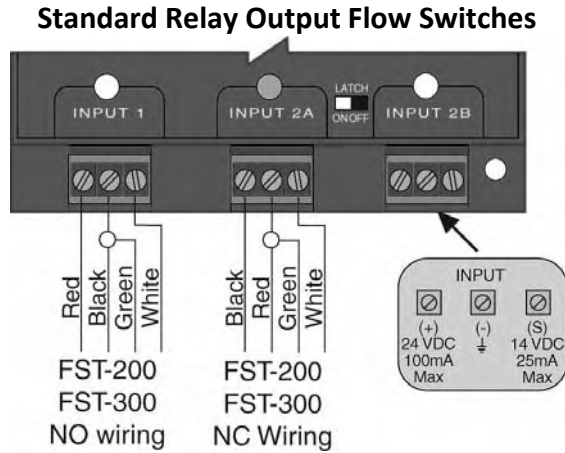

Panel DIN Rail Mounting: The controller may be mounted by either a back panel using two screws through mounting holes located at the corners of the controller or by snapping the controller on 35 mm DIN Rail.

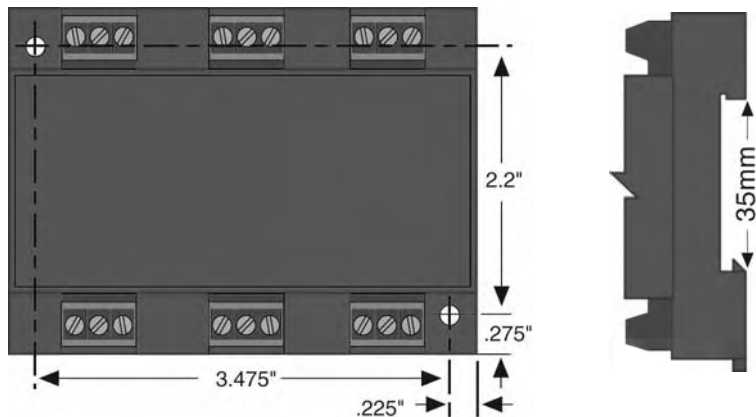

Note: Always install the controller in a location where it does not come into contact with liquid.

LED Indication: Use LED's located above the input terminals to indicate whether the switch is in a Flow or No-Flow state. With the flow switch wired NC, the Amber LED indicates *No-Flow* and no LED indicates *flow*. Wiring the switch NO (reversing the Red and Black wires), the Amber LED indicates *Flow* and no LED indicates *No-Flow*.

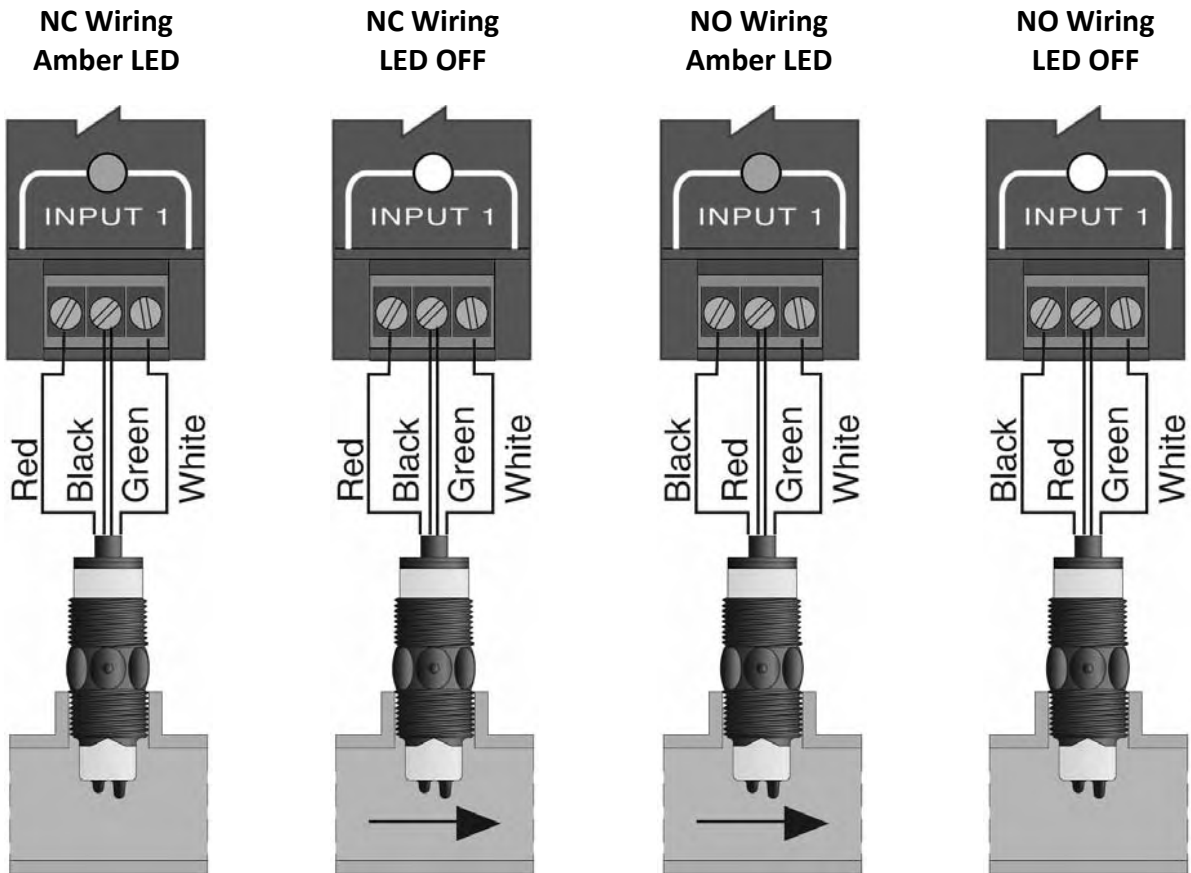

Low Flow Alarm: The goal is to indicate when the flow rate falls below a certain point. If it does, an alarm is supposed to sound, alerting the operator of a low flow condition. The flow switch is wired to Input 1 and the alarm is wired through Relay 1.

If power is accidentally cut to the controller, the sensor's ability to notify the operator of a low flow condition could be lost. The system must alert the operator not only to low flow, but to controller power loss. To do this, connect the hot lead of the alarm to the NC side of the relay terminal of the controller. If power is lost, the relay will be de-energized, and the alarm will sound (if there is still power to the alarm circuit itself). The alarm circuit should have a non-interruptible power supply or some other indicator or backup alarm to warn of a power failure in the alarm circuit.

In this application, the normal status is when the sensor is in the flow condition, and the relay will be energized holding the alarm circuit Open.

- If the switch is wired NC, the input LED will be OFF and the relay LED will be ON. So for this wiring configuration, Invert should be set to the ON position.
- If the switch is wired NO, the input LED and the relay LED will be ON simultaneously. So for this wiring configuration, Invert should be set to the OFF (-) position.

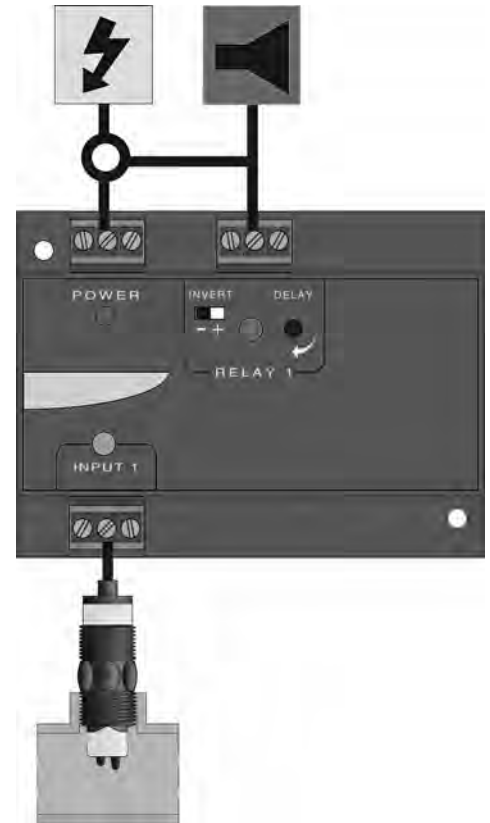

Dual Flow Alarm: The goal is to indicate when the flow rate falls below a certain point on two different lines. If it does, an alarm is supposed to sound, alerting the operator of a low flow condition for the specific line. For Line #1, the flow switch is wired to Input 1 and the alarm is wired through Relay 1. For Line #2, the flow switch is wired to Input 2A and the alarm is wired through Relay 2.

Accidental power cut to the controller must be taken into account as in the Low Flow Alarm example seen above. Follow the same logic for Low Flow Alarm as with Dual Flow Alarm.

In this application, the normal status is when the sensor is in the flow condition, and the relay will be energized holding the alarm circuit Open.

- If the switches are wired NC, the input LED will be OFF and the relay LED will be ON. So for this wiring configuration, Invert should be set to the ON position.
- If the switches are wired NO, the input LED and the relay LED will be ON simultaneously. So for this wiring configuration, Invert should be set to the OFF (-) position.

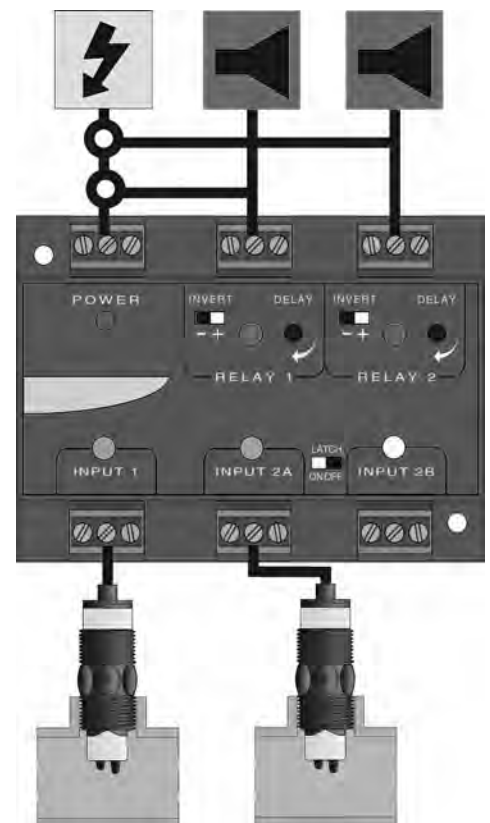

Set Points: If the preset factory calibration is not adequate for your application, follow the calibration steps listed below. **Note:** the switch's internal LED will be on when the switch detects no-flow and will off when the switch detects flow.

1. Install the fitting and flow switch as described in the Installation section of this manual. Turn the flow switch and controller power on and adjust the flow rate to the application setting. If the medium to be sensed is likely to be subject to high temperature variations, the flow switch should be set at the highest normal temperature likely to be encountered.
2. Locate the potentiometer knob at the top of the flow switch. The red LED is visible through the potentiometer. (If the LED is on, slowly adjust the potentiometer counterclockwise, with a small flat head screwdriver until the LED turns off.) The adjustment is a single turn 270° potentiometer. The initial response time of the flow switch after adjustment is 1 to 10 seconds. Adjust the potentiometer in slow increments and wait for the response. If the LED is off, slowly adjust the potentiometer clockwise until the light turns on. Then turn the potentiometer counterclockwise to bring the LED off at a reliable setting. Remember, adjust the potentiometer in slow increments and wait for the response.
3. Verify that the new calibration is correct by lowering the system flow rate below the set point and check to see that the red LED turns on. Then increase the flow rate above the set point and verify that the red LED turns off accordingly.



**Liquid Switch
FST-200 Series**

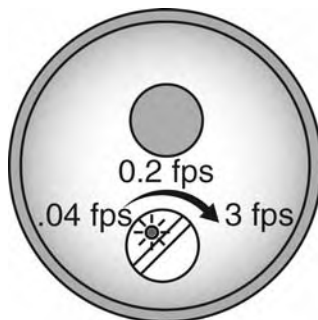

**Gas Switch
FST-300 Series**

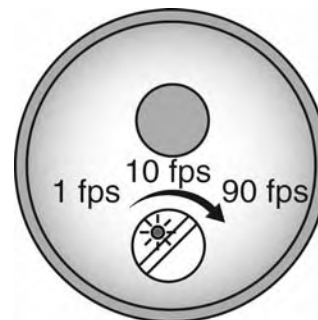

Controller Logic: Please use the following guide to understand the operation of the controllers.

1. **Power LED:** Make sure the Green power LED is ON when power is supplied to the controller.
2. **Input LED:** For NC switch wiring, the input LED on the controller will be Amber when the switch reads no-flow and OFF when the switch reads flow.
3. **Invert Operation:** When the input LED turn OFF and ON, the relay LED will also switch. With invert OFF, the relay LED will be ON when the input LED is ON and OFF when the input LED is OFF. With invert ON, the relay LED will be OFF when the input LED is ON and ON when the input LED is OFF.
4. **Relay Operation:** The relay may be wired either NO or NC. The normal state of the relay is when its LED is OFF. With the LED ON, the relay is in the energized mode and all terminal connections are reversed.

Troubleshooting:

PROBLEM	SOLUTION
Controller is powered, but nothing happens.	First check the Power LED to make sure it is Green. If not, check the wiring, power and make sure the terminal is seated correctly over the 6-pins.
A Flow or No-Flow condition is met but the relay did not switch.	Check the relay by switching the invert switch. Confirm that relay click on and off as well as the relay LED.
The Flow or No-Flow is not switching at the correct flow rate.	The flow switch may need to be adjusted. Review the Flow Switch Calibration section on the previous page for instructions on setting the actual flow switch. Note: access to the flow switch adjustment is difficult and requires the removal of the PCB assembly. Use caution when performing this step.
Trying to start the flow but the controller keeps turning the flow off.	To restart a flow condition, the sensor needs to sense an actual flow condition before changing the relay in the controller. A flow switch over-ride may need to be added across the relay contacts that allows for a true flow to occur before switching back to the controller. The use of a moment switch is recommended for the over-ride switch.
Relay LED does not match my flow condition.	The relay LED can be switched by either the reversing the wiring of the sensor to the controller or by flipping the invert switch. This means that the relay LED can either be set to turn on during a flow condition or to turn off during a no-flow condition. This is all dependent on the wiring and the invert position.
Relay LED does not match the sensor's LED indicator.	The sensor's LED will always be ON during a No-Flow state and OFF during a Flow state, regardless of the switches wiring. As per above the input LED can be inverted to any condition. In some applications, they will match and in others they will be opposite. This is all dependent on the application parameter/setup.

Relay Latch Logic (Relay 2, LVCN-131 Series only): The relay can either be an independent relay (high or low level alarm) or a latching relay (automatic fill or empty) with latch ON. With Latch OFF, the relay will only respond to the Input 2A. Input 2B will be ignored. This configuration is ideal for alarming, such as flow, no-flow, leak detection, high level or low level.

When the Latch switch is ON, Relay 2 requires that both Inputs 2A and 2B to be in the same state before the relay will switch.

In an auto fill application, when the bottom switch is dry (top switch is also dry) the relay will energize. The relay will remain in an energized state until the top switch becomes wet (bottom switch is also wet). At this point, the relay will de-energize and remain de-energized until the bottom switch becomes dry again.

The same logic applies for auto empty applications. The only change is that the relay will energize when the top is wet (bottom is also wet) and de-energize when the bottom is dry (top is also dry).

In both scenarios, when the level is between the two sensors, the relay will not change state, regardless of is the liquid is rising or falling. This logic is ideal for the controlling of liquid between to unique/different set points. The differential is controlled by the location of the two sensors.

With Latch ON, the relay will actuate when Input 2A and Input 2B are in the same condition. The relay will not change its condition until both inputs reverse their state.

Invert OFF		Latch OFF
Input 2A	Input 2B	Relay
ON	No Effect	ON
OFF	No Effect	OFF

Invert OFF		Latch OFF
Input 2A	Input 2B	Relay
ON	No Effect	OFF
OFF	No Effect	ON

Caution: Some sensors may have their own inverting capability (wired NO or NC). This will change the logic of the invert switch. Check your system design.

Invert OFF		Latch ON
Input 2A	Input 2B	Relay
ON	ON	ON
OFF	ON	No Change
ON	OFF	No Change
OFF	OFF	OFF

Invert ON		Latch ON
Input 2A	Input 2B	Relay
ON	ON	OFF
OFF	ON	No Change
ON	OFF	No Change
OFF	OFF	ON

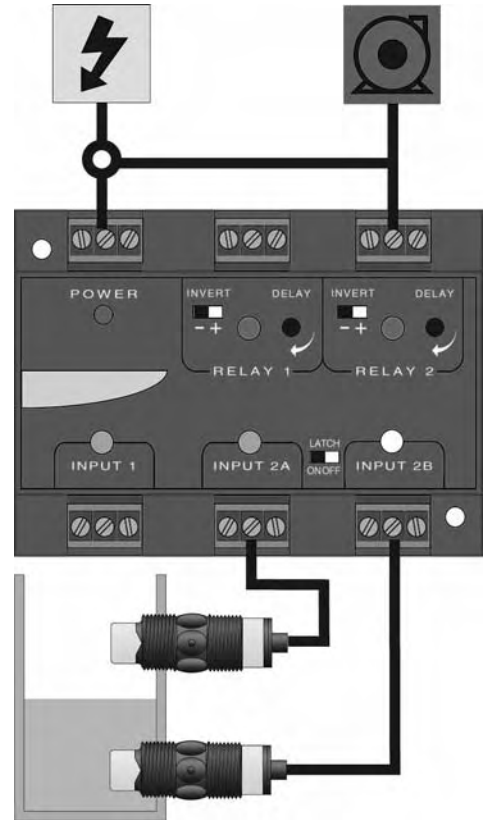



WARRANTY/DISCLAIMER

OMEGA ENGINEERING, INC. warrants this unit to be free of defects in materials and workmanship for a period of **13 months** from date of purchase. OMEGA's WARRANTY adds an additional one (1) month grace period to the normal **one (1) year product warranty** to cover handling and shipping time. This ensures that OMEGA's customers receive maximum coverage on each product.

If the unit malfunctions, it must be returned to the factory for evaluation. OMEGA's Customer Service Department will issue an Authorized Return (AR) number immediately upon phone or written request. Upon examination by OMEGA, if the unit is found to be defective, it will be repaired or replaced at no charge. OMEGA's WARRANTY does not apply to defects resulting from any action of the purchaser, including but not limited to mishandling, improper interfacing, operation outside of design limits, improper repair, or unauthorized modification. This WARRANTY is VOID if the unit shows evidence of having been tampered with or shows evidence of having been damaged as a result of excessive corrosion; or current, heat, moisture or vibration; improper specification; misapplication; misuse or other operating conditions outside of OMEGA's control. Components in which wear is not warranted, include but are not limited to contact points, fuses, and triacs.

OMEGA is pleased to offer suggestions on the use of its various products. However, OMEGA neither assumes responsibility for any omissions or errors nor assumes liability for any damages that result from the use of its products in accordance with information provided by OMEGA, either verbal or written. OMEGA warrants only that the parts manufactured by the company will be as specified and free of defects. OMEGA MAKES NO OTHER WARRANTIES OR REPRESENTATIONS OF ANY KIND WHATSOEVER, EXPRESSED OR IMPLIED, EXCEPT THAT OF TITLE, AND ALL IMPLIED WARRANTIES INCLUDING ANY WARRANTY OF MERCHANTABILITY AND FITNESS FOR A PARTICULAR PURPOSE ARE HEREBY DISCLAIMED. LIMITATION OF LIABILITY: The remedies of purchaser set forth herein are exclusive, and the total liability of OMEGA with respect to this order, whether based on contract, warranty, negligence, indemnification, strict liability or otherwise, shall not exceed the purchase price of the component upon which liability is based. In no event shall OMEGA be liable for consequential, incidental or special damages.

CONDITIONS: Equipment sold by OMEGA is not intended to be used, nor shall it be used: (1) as a "Basic Component" under 10 CFR 21 (NRC), used in or with any nuclear installation or activity; or (2) in medical applications or used on humans. Should any Product(s) be used in or with any nuclear installation or activity, medical application, used on humans, or misused in any way, OMEGA assumes no responsibility as set forth in our basic WARRANTY/DISCLAIMER language, and, additionally, purchaser will indemnify OMEGA and hold OMEGA harmless from any liability or damage whatsoever arising out of the use of the Product(s) in such a manner.

RETURN REQUESTS/INQUIRIES

Direct all warranty and repair requests/inquiries to the OMEGA Customer Service Department. BEFORE RETURNING ANY PRODUCT(S) TO OMEGA, PURCHASER MUST OBTAIN AN AUTHORIZED RETURN (AR) NUMBER FROM OMEGA'S CUSTOMER SERVICE DEPARTMENT (IN ORDER TO AVOID PROCESSING DELAYS). The assigned AR number should then be marked on the outside of the return package and on any correspondence.

The purchaser is responsible for shipping charges, freight, insurance and proper packaging to prevent breakage in transit.

FOR **WARRANTY** RETURNS, please have the following information available BEFORE contacting OMEGA:

1. Purchase Order number under which the product was PURCHASED,
2. Model and serial number of the product under warranty, and
3. Repair instructions and/or specific problems relative to the product.

FOR **NON-WARRANTY** REPAIRS, consult OMEGA for current repair charges. Have the following information available BEFORE contacting OMEGA:

1. Purchase Order number to cover the COST of the repair,
2. Model and serial number of the product, and
3. Repair instructions and/or specific problems relative to the product.

OMEGA's policy is to make running changes, not model changes, whenever an improvement is possible. This affords our customers the latest in technology and engineering.

OMEGA is a registered trademark of OMEGA ENGINEERING, INC.

© Copyright 2009 OMEGA ENGINEERING, INC. All rights reserved. This document may not be copied, photocopied, reproduced, translated, or reduced to any electronic medium or machine-readable form, in whole or in part, without the prior written consent of OMEGA ENGINEERING, INC.

Where Do I Find Everything I Need for Process Measurement and Control?

OMEGA...Of Course!

Shop online at omega.comSM

TEMPERATURE

- M Thermocouple, RTD & Thermistor Probes, Connectors, Panels & Assemblies
- M Wire: Thermocouple, RTD & Thermistor
- M Calibrators & Ice Point References
- M Recorders, Controllers & Process Monitors
- M Infrared Pyrometers

PRESSURE, STRAIN AND FORCE

- M Transducers & Strain Gages
- M Load Cells & Pressure Gages
- M Displacement Transducers
- M Instrumentation & Accessories

FLOW/LEVEL

- M Rotameters, Gas Mass Flowmeters & Flow Computers
- M Air Velocity Indicators
- M Turbine/Paddlewheel Systems
- M Totalizers & Batch Controllers

pH/CONDUCTIVITY

- M pH Electrodes, Testers & Accessories
- M Benchtop/Laboratory Meters
- M Controllers, Calibrators, Simulators & Pumps
- M Industrial pH & Conductivity Equipment

DATA ACQUISITION

- M Data Acquisition & Engineering Software
- M Communications-Based Acquisition Systems
- M Plug-in Cards for Apple, IBM & Compatibles
- M Datalogging Systems
- M Recorders, Printers & Plotters

HEATERS

- M Heating Cable
- M Cartridge & Strip Heaters
- M Immersion & Band Heaters
- M Flexible Heaters
- M Laboratory Heaters

ENVIRONMENTAL MONITORING AND CONTROL

- M Metering & Control Instrumentation
- M Refractometers
- M Pumps & Tubing
- M Air, Soil & Water Monitors
- M Industrial Water & Wastewater Treatment
- M pH, Conductivity & Dissolved Oxygen Instruments