

2 YEAR
WARRANTY

NIST

Ω OMEGA™ **User's Guide**



***Shop online at
omega.com***

e-mail: info@omega.com
***For latest product manuals:
www.omegamanual.info***

BB701 **Blackbody Calibrator**



omega.com info@omega.com

Servicing North America:

**U.S.A.
Headquarters:**

Omega Engineering, Inc.

Toll-Free: 1-800-826-6342 (USA & Canada only)

Customer Service: 1-800-622-2378 (USA & Canada only)

Engineering Service: 1-800-872-9436 (USA & Canada only)

Tel: (203) 359-1660

Fax: (203) 359-7700

e-mail: info@omega.com

For Other Locations Visit omega.com/worldwide

Table of Contents

Section	Page
Section 1 Introduction	1-1
1.1 Precautions	1-1
1.2 Safety Warnings and IEC Symbols	1-1
1.3 General Description	1-2
Section 2 Installation	2-1
2.1 Unpacking and Inspection	2-1
2.2 Mounting	2-1
2.3 Ambient Temperature	2-2
2.4 Power Connection	2-2
Section 3 Operation	3-1
3.1 Front Panel Controls and Indicators	3-1
3.2 Back Panel Connections	3-3
3.3 Changing the Temperature Setpoint	3-4
3.4 Changing the Controller Parameters	3-4
3.5 Heat-Up/Cool-Down Cycle Time Graphs	3-5
3.6 Target Plate Air Purge	3-6
Section 4 Serial Communication	4-1
Section 5 Maintenance	5-1
5.1 Calibration	5-1
5.2 Cleaning	5-1
5.2.1 Main Body	5-1
5.2.2 Target Plate	5-1
5.2.3 Fan	5-1
5.3 Fuse Replacement	5-1
Section 6 Reference Probe	6-1
Section 7 Specifications	7-1
Section 8 Troubleshooting Guide	8-1
Section 9 Glossary of Terms Used in This Manual	9-1

Table of Figures

Figure Description:.....	Page:
1. I.E.C. Symbols	1-2
1. The Effect of Increased Ambient Temperature on Operating Temperatures	1-2
3. Front Panel	3-1
4. Back Panel	3-3
5. Menu Hierarchy Showing Factory Default Settings	3-4
6. Changing The Controller's Parameter Settings	3-5
7. Heat Up/Cool Down Transition Time Table	3-5
8. Connecting the BB701 to a Computer's Serial Port	4-1
9. Internal Reference Probe Connections	6-1

Section 1 - Introduction

Your BB700 Series Blackbody Calibration Source has been designed for ease of use and reliability whenever you have the need to test or calibrate non-contact infrared temperature instruments. It is important that you read this manual completely and follow all safety precautions before operating this instrument.

1.1 Precautions

- Follow all safety precautions and operating instructions outlined in this manual.
- Never leave your calibrator unattended when in use.
- Keep out of reach of children.
- Never touch the target plate when hot.
- Never place any object within 3 inches of the cavity opening when hot.
- Do not operate in flammable or explosive environments.
- Never operate with a power cord other than the one provided with your unit.
- Remove and or disconnect main power cord before attempting any maintenance or fuse replacement.
- Do not connect and or operate this unit to a non-grounded, non-polarized outlet or power source.
- Do not connect the serial port or reference probe port to equipment with exposed, hazardous, live voltages.

NOTE:

There are no user serviceable parts inside your unit. Attempting to repair or service your unit may void your warranty.

1.2 Safety Warnings and IEC Symbols

This device is marked with international safety and hazard symbols in accordance with IEC 1010. It is important to read and follow all precautions and instructions in this manual before operating or commissioning this device as it contains important information relating to safety and EMC. Failure to follow all safety precautions may result in injury and or damage to your calibrator. Use of this device in a manner not specified by the manufacturer may impair protection provided within the unit.

IEC symbols

Description

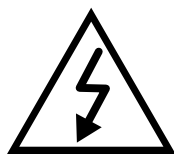

Caution, risk of electric shock



Caution, refer to accompanying documents



Caution, hot surface



230 VAC @50Hz (European Models)
115 VAC @60Hz (Domestic Models)

Figure 1. IEC symbols

1.3 General Description

The Model BB701 is a portable, rugged, bench-top, hot/cold blackbody calibration source with a built-in precision PID digital controller. The calibrator is used to test and calibrate infrared pyrometers. The large 2.5 inch Diameter target plate has an emissivity of 0.95 and can be set to any temperature between -18 to 149°C (+0 to 300°F).

Section 2 - Installation

2.1 Unpacking

Remove the packing list and verify that you have received all your equipment. If you have any questions about the shipment, please call our Customer Service Department.

We can also be reached on the Internet.

When you receive the shipment, inspect the container and equipment for any signs of damage. Note any evidence of rough handling in transit. Immediately report any damage to the shipping agent.

NOTE:

The carrier will not honor any damage claims unless all shipping material is saved for inspection. After examining and removing contents, save packing material and carton in the event reshipment is necessary.

The following items are supplied in the box:

- BB701 Blackbody Calibration Source
- User's Manual
- Calibration Certificate
- Power Cord
- Connector

2.2 Mounting

Mount the unit on a bench, table top or shelf in a horizontal position and operate at least ten inches from any air obstructions to the fan, front panel, rear panel, and top of the unit. Operate the unit in an ambient environment between the specified 4.4 to 43°C (40 to 110°F).

2.3 Ambient Temperature

The target plate of the BB701 can achieve any temperature within the specified temperature range of -18 to 149°C (+0 to 300°F) when being operated in normal ambient temperature environments. The maximum specified target plate temperature of 149°C (300°F) can be achieved over the entire specified ambient temperature range. However, the lower target plate temperatures are more difficult to attain at increased ambient temperatures. As long as the ambient temperature does not exceed 29.4°C (85°F), the target plate will achieve its lower limit temperature of -18°C (0°F). The minimum target plate temperature the unit can achieve is proportionally worse with increased ambient temperature.

An increase of 1°C is accompanied by an increase in minimum target plate temperature of 0.3°C (An increase of 1°F is accompanied by an increase in minimum target plate temperature of 0.5°F).

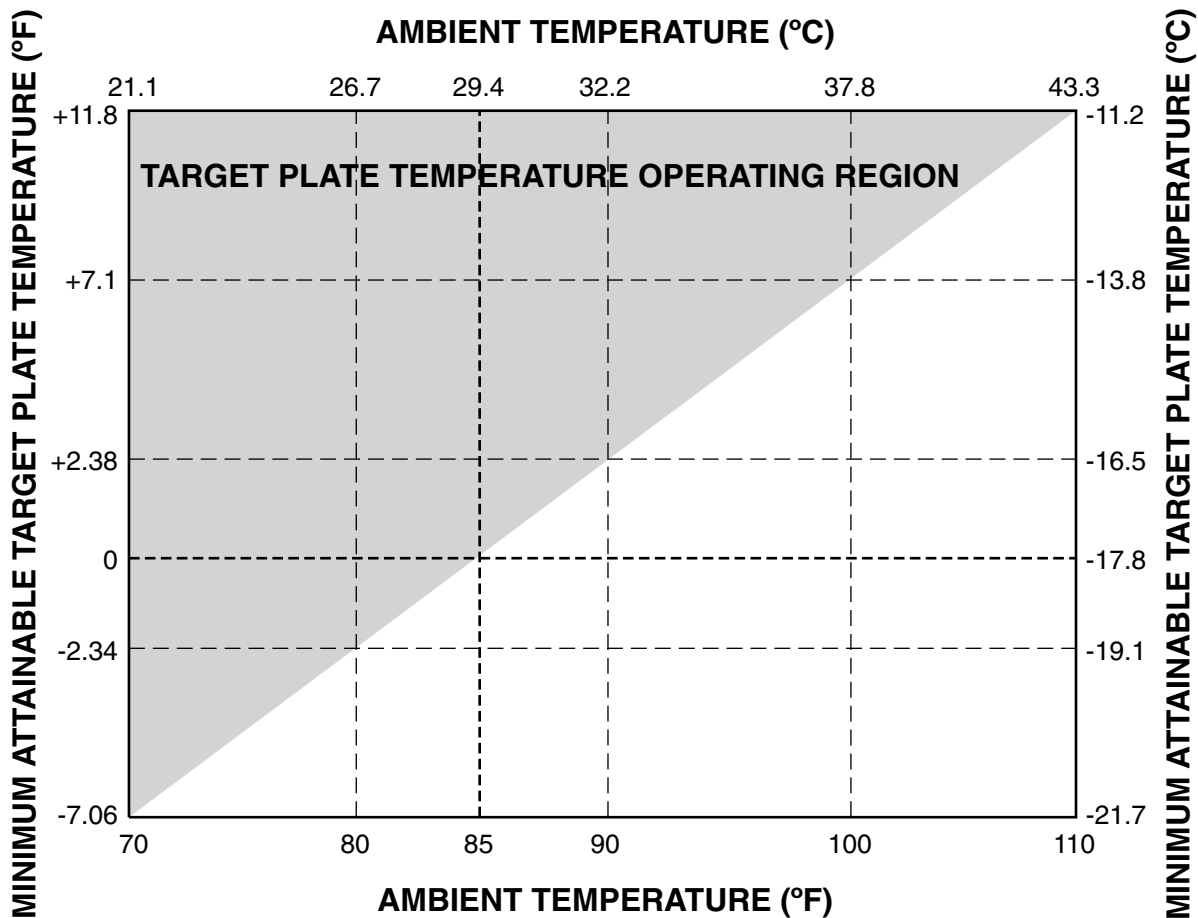

Figure 2. The Effect of Increased Ambient Temperature on Operating Temperatures

2.4 Power Connection

Standard (115 VAC~, 50/60 Hz models)

The BB701 comes with a standard North American 3-prong AC power cord. Do not use any other power cord other than the one provided. This cord provides the proper grounding and has been safety tested by the proper safety agencies.

Domestic (230 VAC~, 50/60 Hz models)

On 230 VAC~, 50Hz models a European style power cord with the proper color code and approvals is provided with stripped wire ends for connection to the proper connector used in your country or local area. This connector is not provided.

CAUTION:

Electrical connections and wiring should be performed only by suitably trained personnel.

Section 3 - Operation

3.1 Front Panel Controls and Indicators

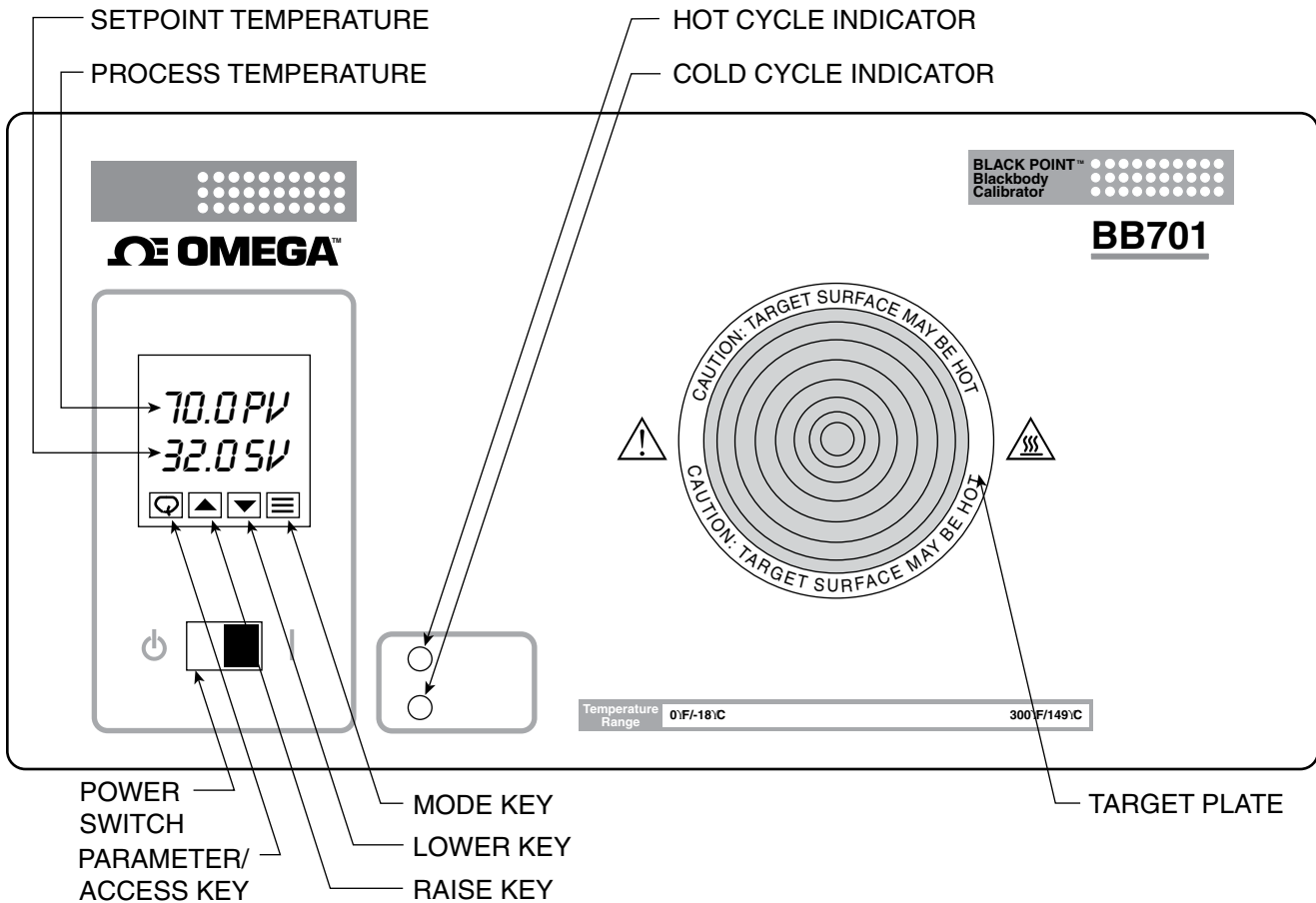

Figure 3. Front Panel

Process Temperature:

This field displays the current temperature of the target plate.

Setpoint Temperature:

This field displays the desired target plate temperature. Once the target plate reaches this desired temperature, both displays will read the same value.

Hot Cycle Indicator:

When this Amber L.E.D. is illuminated, the unit is heating up the target plate.

Cold Cycle Indicator:

When this Blue L.E.D. is illuminated, the unit is cooling down the target plate.

NOTE:

P.I.D. Control:

Proportional, integral, derivative control (P.I.D.) is a temperature control algorithm used in high-end temperature controllers. The controller causes the process to attain the desired temperature by turning the process on or off. The process may be a heater or refrigerator. As the process temperature approaches the setpoint temperature the hot or cold process will be pulsed to reduce the corrective measures and minimize overshooting. The controller provides a visual representation of the process status through LED indicators. An indicator may be lit continuously, blink or shut off entirely to indicate that the process is on, being pulsed, or off, respectively.



Parameter / Access Key:

Press to scroll through menu parameters



Raise Key:

Press to increase the selected parameter or scroll upward in the list of possible settings.



Lower Key:

Press to decrease the selected parameter or scroll downward in the list of possible settings.



Mode Key:

Press to save settings and exit a menu level.

Target Plate:

The 2.5" target plate is a near ideal blackbody source. The emissivity of the plate is 0.95. When calibrating an IR pyrometer, hold the pyrometer perpendicular to the target plate for optimal performance. The proper distance between the IR pyrometer and the target plate depends on the field of view of the pyrometer. If the pyrometer is too far away it will scan unwanted surfaces outside of the perimeter of the target plate. Holding the pyrometer too close could introduce undesirable heat to the IR detector of the pyrometer.

3.2 Back Panel Connections

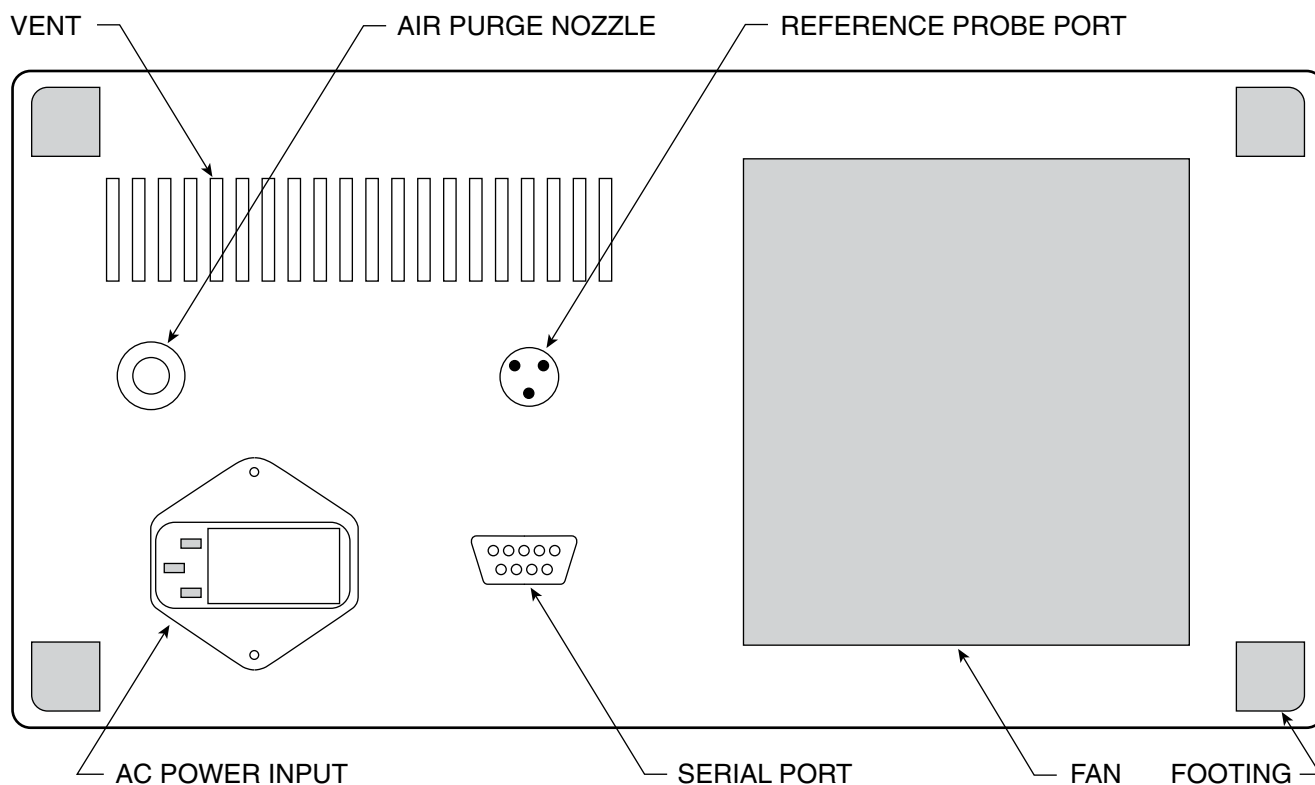

Figure 4. Back Panel

AC Power Input:

The customer connects the power cord to the AC Power Input. As a safety precaution, the power cord cannot be connected if the fuse compartment is open. Refer to Section 5.3 for information on fuse replacement.

Reference Probe Port:

The reference probe port enables the user to monitor the target plate temperature with an external instrument. The wires are connected to a platinum 3-wire RTD. Refer to Section 6 for a pinout.

Air Purge Nozzle:

A dry gas source can be connected to this nozzle in order to minimize condensation on the target plate when operating at low temperatures. Refer to Section 3.6 for detailed information.

Serial Port:

The female DB-9 port allows the customer to make a 3-wire RS232 interface with the BB701. A detailed description of this port is described in Section 4.

3.3 Changing the Temperature Setpoint

The layout of the front panel is shown in Figure 3. The BB701 incorporates a PID digital setpoint controller. The upper display indicates the blackbody target plate temperature known as (PV) Process Variable, while the lower display indicates the programmed setpoint known as (SV) Setpoint Variable. Making changes to the setpoint, units can be made via the ▲ and ▼ keys. Holding a key in, continuously, will cause the setpoint temperature to advance more quickly to a desired value. Three scanning speeds are provided: slow, medium and fast. The minimum and maximum setpoints are locked at 0 and 300°F, respectively. While these max. and min. settings are changeable (see “Changing the Internal Parameters,” Section 3.4), it is strongly advised not to adjust these parameters.

3.4 Changing the Controller Parameter Settings

The BB701 operates at its optimum performance when left with its factory parameter settings. The only internal parameter that the operator should feel the need to change is the engineering units (°C or °F), display resolution (XXX, XXX.X or X.XX) or serial communications parameters. Below are two diagrams:

- Menu Hierarchy Showing Factory Default Settings
- Changing The Controller's Parameter Settings.

Menu 00	Menu 01	Menu 02	Menu 03	Menu 04	Menu 05		
Key Lock	SETPOINT	Ac.Cd = 02	Ac.Cd = 03	Ac.Cd = 04	Ac.Cd = 05		
	Ac.Cd						
	Gn.o1	128	ALr1	id.no	01	SnSr	d
	Gr.o2	1.1	ALr2	bAUd	12.o.7	Sn.00	
	rAtE	03	Cy.t1	00	CAL.L	dEC.P	
	rSEt	12	Cy.t2	00	CAL.H	FILt	
	H.Hys		SP.tt	OFF		OUt.1	Ht.P
	HyS.1		L.SP.L	0.0		OUt.2	CL.P
	C.HyS		L.SCL			CoL.t	nor
	HyS.2		U.SP.L	300.0		A1.HL	HI
	C.SPr		H.SCL			A1.Pd	Pr
	SPr.2					A1.OP	OFF
	dPnG	NI				A2.HL	LO
						A2.Pd	Pr
						A2.OP	OFF
						Unit	F

Figure 5. Menu Hierarchy Showing Factory Default Settings

NOTE

Only the boldface parameters are active for the default mod of operation. The other parameters are not valid for operation with the BB701. They are only listed for the sake of complete documentation of the controller.







1. Press the  key to enter the programming mode. The lower display will alternately display the menu level and "Ac.Cd."
2. Use the  and  keys to change to the desired menu level.
3. Once you have chosen the desired menu use the  key to scroll through the parameters. To change the setting of a given parameter, use the  and  keys.
4. To save settings press the  key. The controller now exits the programming menu and return to the normal operating mode.
5. To change settings on other menu levels, you must re-enter the programming menu (from step #1).

Figure 6. Changing the Controller's Parameter Settings

3.5 Heat-Up/Cool-Down Cycle Transition Times

The following table shows the amount of time required to change the target plate temperature from one setpoint to another. The starting temperature is shown along the left side. The final temperature is shown along the top. All transition times are approximate.

		FINAL TEMPERATURE					
		-18°C	0°C	37.8°C	93.3°C	148.9°C	
		0°F	32°F	100°F	200°F	300°F	
START TEMP.	-18°C	0°F	6.0 min.	1.5 min.	2.0 min.	3.0 min.	7.0 min.
	0°C	32°F	6.0 min.	1.5 min.	1.5 min.	3 min.	7 min.
	37.8°C	100°F	13.5 min.	3.0 min.	3.0 min.	2.5 min.	6.5 min.
	93.3°C	200°F	21.5 min.	7.0 min.	3.0 min.	2.5 min.	5.0 min.
	148.9°C	300°F	22.0 min.	8.5 min.	4.5 min.	2.5 min.	5.0 min.

Figure 7. Heat Up/Cool Down Transition Time Table

3.6 Target Plate Air Purge

The BB701 comes with a nitrogen air purge collar that surrounds the target plate. When connected to a nitrogen gas source the target plate is kept free of condensation at lower temperatures. Snow is likely to form on the plate when it is kept at temperatures below freezing temperature. Snow or condensation will change a target's emissivity. This can lead to inaccuracies unless the infrared pyrometer is corrected for this emissivity change.

It is therefore recommended that the user take advantage of this feature. Use dry gas or Nitrogen with a dew point below -20°C (-4.0°F). The rate of gas inlet should be 0.25 to 0.50 m^3/hr . (5 to 10 ft^3/hr .). Do not exceed the maximum gas inlet rate. The port will accept any flexible tubing (vinyl, rubber, PTFE, latex) with an 1/4" outer diameter, such as OMEGA™ #TYVY-1418-100-A.

Section 4 - RS232 Communication

The RS232 communications port allows bi-directional data transfer via a three conductor cable consisting of signal ground, receive input, and transmit output. It is recommended that less than fifty feet of cable be used between the computer and this instrument.* Note that multiple instruments cannot be tied to the same port in this configuration. The RS232 port is optically isolated to eliminate ground loop problems.

Below is a pinout diagram for the serial port of the BB701 as well as the pinout for a 9-pin PC serial port. Use a straight DB9 (female) to DB9 (male) connector cable to connect your computer to the BB701. The cable should be attached only when the computer and BB701 are off.

Only parameters in the parameter list should be modified or queried via the serial port. Other parameters can be viewed or queried from the controller, directly. It is highly recommended that baud rate for the controller be modified on the controller, directly. Note that both the BB701 and the computer must be communicating with the same serial communications parameters to establish a working communication link.

The serial communications feature can be tested using any standard terminal emulation package. Note that this controller does not time out waiting for the next character to be transmitted. Be sure not to use the XON/XOFF or hardware handshaking. Lastly, it should be noted that following a complete transmission to the BB701, a response is sent back. If the message was valid, the changed or queried parameter is echoed back (following the same format). If the message was not according to acceptable format or was attempting to force a parameter out of range, an "ERROR" message is echoed.

*This will assure performance of the BB701 within the CISPR11/EN55011:1991 standards, under the E. M. C.

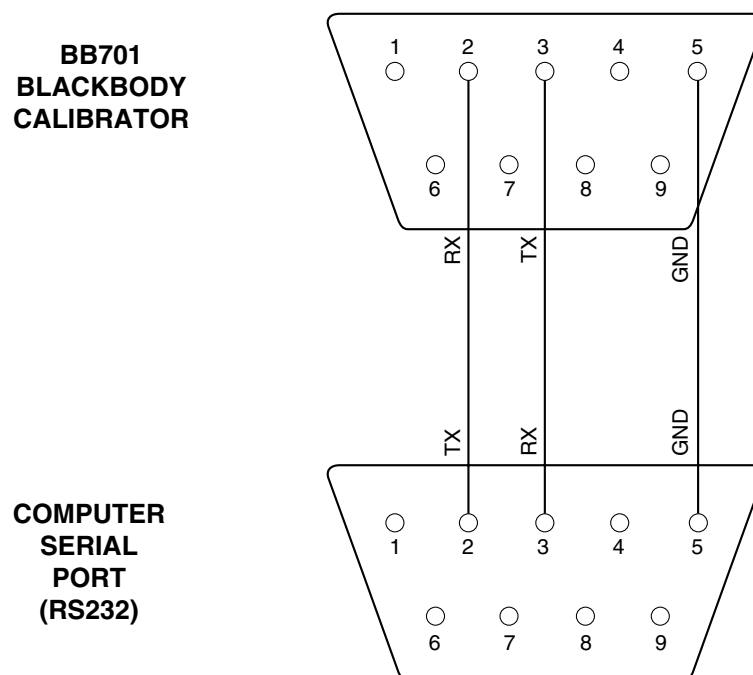

Figure 8. Connecting the BB701 to a Computer's Serial Port

Parameter List (only relevant parameters shown):

PAR#:	Parameter:	Range/Units:
00	Process Temp.	Input determined
01	Setpoint	Input determined
19	Baud Selection	bAUD

Baud Selections:

Code:	Baud:	Parity:	Data Bits:	Stop Bits:
3.o.7	300	odd	7	2
6.o.7	600	odd	7	2
12.o.7	1200	odd	7	2 (factory default settings)
24.o.7	1200	odd	7	2
3.n.8	300	no	8	1
6.n.8	600	no	8	1
12.n.8	1200	no	8	1
24.n.8	2400	no	8	1

General Message Format:

#[controller id][command][parameter number]<new value><units>[CR/LF]

Definitions:

- This character initiates an "escape sequence" that the controller will recognize.

[controller id] – Up to 2 numeric characters, "00" to "99" (factory default="01")

[command] – 1 character, upper case or lower case

"R" – To read a parameter from the controller

"M" – To temporarily modify a controller parameter (lost upon shutdown)

"E" – To modify a controller parameter in non-volatile mem. (saved even after shutdown)

[parameter #] – Up to 2 numeric characters, "00" to "99"

<new value> - This control word is used only when entering or modifying a parameter.

Up to 6 characters may be entered. The first character can be a space, a "+", or a "-". The next 4 characters are for entering the new value parameter value. Be sure to use the exact same field format as is currently being used. (i.e. if the

XXX.X format is used to express temperature, be sure to enter a new value that conforms to the same format).

<units> - This optional control word is used to specify units, C for °C (F for °F).

[CR/LF] – Every transmission must be terminated with a carriage return [CR] character.

The line feed [LF] character is optional.

Section 5 - Maintenance

5.1 Calibration

This unit has been fine tuned at the factory and calibrated to give optimum performance of its full temperature range. It is recommended that the unit be returned annually for re-calibration.

5.2 Cleaning



CAUTION:

Remove all electrical connections and power before attempting any maintenance or cleaning.

5.2.1 Main Body

Only a damp soft rag with a mild cleaning solution should be used to clean the main body of this unit.

5.2.2 Target Plate

Do not attempt to clean the target plate. The target plate has a special coating applied and cleaning may change the emissivity and performance of your unit.

5.2.3 Fan

The fan filter should be removed and cleaned as a minimum, monthly, by washing the filter with warm water and then blowing dry with air. It can be removed by firmly pulling the black plastic frame outward. The internal protective grill that is seated against the fan can be cleaned with a soft bristle brush.

5.3 Fuse Replacement



WARNING:

Disconnect all power from source before attempting fuse replacement.



CAUTION:

For continued protection against the risk of fire replace with only the same size, type and rating fuse indicated here and on the rear panel of your unit.

For model: BB701 use

1 ea. 250 VAC~, F1A (Fast-Acting, 4 Amp)
UL./CSA APPROVED (.25 dia. x 1.25 long).

For model: BB701 -230VAC

use 2 ea. 250 VAC~, F1.25A (Fast-Acting, 2 Amp)
VDE APPROVED (5mm dia. x 20mm long).

Section 6 - Reference Probe

An RTD probe has been embedded into the target plate heater assembly to be used as a reference. A connector has been provided with your calibrator for connection to this reference probe.

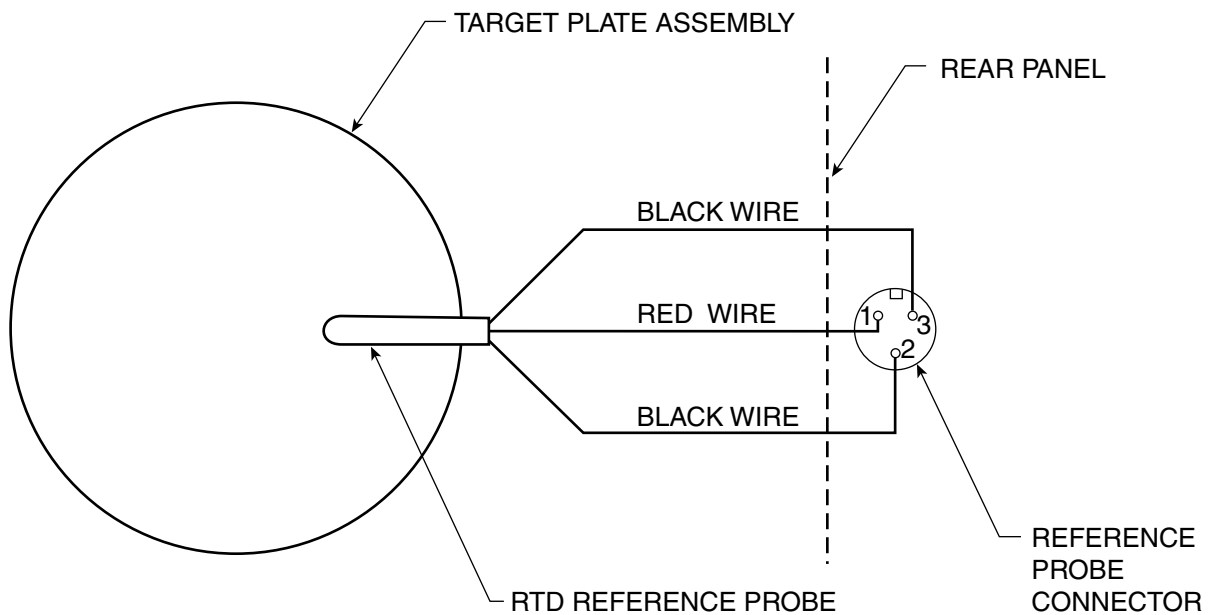

Figure 9. Internal Reference Probe Connections

Section 7 - Specifications

Target Plate Temperature Range:	-18.8 to 150°C (+0 to 300°F).
Accuracy:	±0.8°C + 1 Digit (±1.4°F) [worst case]
Display Accuracy:	±0.3°C (±0.6°F) [over entire scale]
RTD Accuracy:	±0.375°C (±0.75°F) [worst case]
Stability:	± 0.1°F or less
Ambient Environmental Conditions	
Temperature:	4.4 to 29.4°C (40 to 85°F) [target plate reaches 0°F] 4.4 to 43.3°C (40 to 110°F) [target plate reaches 11.8°F]
Humidity:	0 to 90% RH, non-condensing
Target Plate Size:	63.5mm (2.5")
Cavity Emissivity:	0.95
Internal Control Sensor:	Platinum RTD, 100 ohm, .00385
Calibration Reference Sensor:	Platinum RTD, 100 ohm, .00385
Warm-up Time:	5 min., from ambient to 149°C (300°F)
Cool-Down Time:	5 min., from ambient to -18°C (0°F)
Power Requirements by Model	
BB701:	115 VAC~, 50/60 Hz, 175W
BB701-230VAC:	230 VAC~, 50/60 Hz, 175W
Size:	19.5 x 35.5 x 36.5 mm (7.75" H x 14.128" W x 15.5" L)
Weight:	4.5 kg (28 lb)
Installation Category	II

Section 8 - Troubleshooting Guide

Problem	Solution
1. Unit will not turn on.	<ol style="list-style-type: none">Check all electrical connections.Check rear panel fuses.Unit requires service, contact our customer service department.
2. Unit turns on but the target plate will not get hot.	<ol style="list-style-type: none">Check that you have entered a setpoint above the ambient temperature.Verify that the controller is set to its factory default settings.Unit requires service, contact our customer service department.
3. Unit turns on but the target plate will not get cold.	<ol style="list-style-type: none">Check that you have entered a setpoint below the ambient temperature.Verify that the controller is set to its factory default settings.Unit requires service, contact our customer service department.
4. Controller display shows "Error" and the target plate will not get hot or cold.	<ol style="list-style-type: none">Unit requires service, contact our customer service department.
5. Target plate temperature will not stabilize to within $\pm .1^{\circ}\text{F}$ of the setpoint temperature.	<ol style="list-style-type: none">Verify that the controller is set to its factory default settings.Unit requires service, contact our customer service department.
6. Unable to communicate with the unit through the RS232 connection port.	<ol style="list-style-type: none">Check that you have made the proper wiring connections between your unit and computer.Check for proper communication parameter settings in the controller and your computer, (i.e. Baud, Parity, etc.)Check that your message string contains the correct letters and characters for the command you want to send.Unit requires service, contact our customer service department.

Section 9 - Glossary of Terms Used in This Manual

Blackbody

A theoretical object that radiates the maximum amount of energy at a given temperature, and absorbs all the energy incident upon it.

Calibration

The process of adjusting an instrument or compiling a deviation chart so that its reading can be correlated to the actual value being measured.

Emissivity

The ratio of energy emitted by a surface to the energy emitted by a blackbody at the same temperature.

IEC

International Electrotechnical Commission

Infrared (IR)

A range of the electromagnetic spectrum extending beyond red visible light from 760 nanometers to 1000 microns.

PID

Proportional, Integral, Derivative. A three mode control action where the controller has time proportioning, integral (auto reset) and derivative rate action.

RTD

Resistance temperature detector

The OMEGA Family of Blackbody Calibrators

Listed below is a selection guide of OMEGA's current line of blackbody calibration sources in addition to the one you have selected. This family of rugged, portable and accurate calibrators cover a wide range of temperatures, target plate sizes and features making them perfect for infrared pyrometer field service testing and laboratory calibrations.

BB701 Hot/Cold Blackbody Calibration Source Temperature Range: -18 to 150°C (0 to 300°F) Emissivity: .95 Cavity Size: 64mm (2.5 inches)	(DOC # 1733) Accuracy: $\pm 0.8^{\circ}\text{C}$ ($\pm 1.4^{\circ}\text{F}$) Ambient Temp.: 4 to 43°C (40 to 110°F) Power: 120 or 230 VAC 50/60 Hz, 175W
BB702 2.5" Target Plate Blackbody Calibration Source Temperature Range: amb. 10 to 216°C (amb. 20 to 420°F) Emissivity: .95 Cavity Size: 64mm (2.5 inches)	(DOC # 1733) Accuracy: $\pm 0.5^{\circ}\text{C}$ ($\pm 0.9^{\circ}\text{F}$, $\pm 0.25\%$ of rdg.) Ambient Temp.: 0 to 50°C (32 to 122°F) Power: 120 or 230 VAC 50/60 Hz, 75W
BB703 Mini Blackbody Calibration Source Temperature Range: amb. 10 to 400°C (amb. 20 to 752°F) Emissivity: .95 Cavity Size: 28.6mm (1.125 inches)	(DOC # 1789) Accuracy: $\pm 1.4^{\circ}\text{C}$ ($\pm 2.5^{\circ}\text{F}$) Ambient Temp.: 32 to 104°C (0 to 40°F) Power: 120 or 230 VAC 50/60 Hz, 175W
BB704 4" Target Plate Blackbody Calibration Source Temperature Range: 100 to 399°C (212 to 750°F) Emissivity: .95 Cavity Size: 44.45mm (1.75 inches)	(DOC # 1788) Accuracy: $\pm 0.8^{\circ}\text{C}$ ($\pm 1.4^{\circ}\text{F}$) Ambient Temp.: 0 to 50°C (32 to 122°F) Power: 120 or 230 VAC 50/60 Hz, 425W
BB705 Laboratory Grade Blackbody Calibration Source Temperature Range: 100 to 1046°C (212 to 1915°F) Emissivity: .985 or better Cavity Size: 44mm (1.75 inches)	(DOC # 1759) Accuracy: $\pm 0.25\%$ of reading $\pm 1.0^{\circ}\text{C}$ ($\pm 1.8^{\circ}\text{F}$) Ambient Temp.: 32 to 110°F Power: 120 or 230 VAC 50/60 Hz, 1100W
BB-4A High Temperature Blackbody Calibration Source Temperature Range: 100 to 982°C (212 to 1800°F) Emissivity: .98 to .99 Cavity Size: 22mm (.88 inches)	(DOC # 1730) Accuracy: $\pm 0.25\%$ of reading $\pm 1.0^{\circ}\text{C}$ ($\pm 1.8^{\circ}\text{F}$) Ambient Temp.: 0 to 50°C (32 to 122°F) Power: 120 or 230 VAC 50/60 Hz, 400W

Please call our sales or customer service department for information and pricing on any new models available.

WARRANTY/DISCLAIMER

OMEGA ENGINEERING, INC. warrants this unit to be free of defects in materials and workmanship for a period of **25 months** from date of purchase. OMEGA's WARRANTY adds an additional one (1) month grace period to the normal **two (2) year product warranty** to cover handling and shipping time. This ensures that OMEGA's customers receive maximum coverage on each product.

If the unit malfunctions, it must be returned to the factory for evaluation. OMEGA's Customer Service Department will issue an Authorized Return (AR) number immediately upon phone or written request. Upon examination by OMEGA, if the unit is found to be defective, it will be repaired or replaced at no charge. OMEGA's WARRANTY does not apply to defects resulting from any action of the purchaser, including but not limited to mishandling, improper interfacing, operation outside of design limits, improper repair, or unauthorized modification. This WARRANTY is VOID if the unit shows evidence of having been tampered with or shows evidence of having been damaged as a result of excessive corrosion; or current, heat, moisture or vibration; improper specification; misapplication; misuse or other operating conditions outside of OMEGA's control. Components in which wear is not warranted, include but are not limited to contact points, fuses, and triacs.

OMEGA is pleased to offer suggestions on the use of its various products. However, OMEGA neither assumes responsibility for any omissions or errors nor assumes liability for any damages that result from the use of its products in accordance with information provided by OMEGA, either verbal or written. OMEGA warrants only that the parts manufactured by the company will be as specified and free of defects. OMEGA MAKES NO OTHER WARRANTIES OR REPRESENTATIONS OF ANY KIND WHATSOEVER, EXPRESSED OR IMPLIED, EXCEPT THAT OF TITLE, AND ALL IMPLIED WARRANTIES INCLUDING ANY WARRANTY OF MERCHANTABILITY AND FITNESS FOR A PARTICULAR PURPOSE ARE HEREBY DISCLAIMED. LIMITATION OF LIABILITY: The remedies of purchaser set forth herein are exclusive, and the total liability of OMEGA with respect to this order, whether based on contract, warranty, negligence, indemnification, strict liability or otherwise, shall not exceed the purchase price of the component upon which liability is based. In no event shall OMEGA be liable for consequential, incidental or special damages.

CONDITIONS: Equipment sold by OMEGA is not intended to be used, nor shall it be used: (1) as a "Basic Component" under 10 CFR 21 (NRC), used in or with any nuclear installation or activity; or (2) in medical applications or used on humans. Should any Product(s) be used in or with any nuclear installation or activity, medical application, used on humans, or misused in any way, OMEGA assumes no responsibility as set forth in our basic WARRANTY/DISCLAIMER language, and, additionally, purchaser will indemnify OMEGA and hold OMEGA harmless from any liability or damage whatsoever arising out of the use of the Product(s) in such a manner.

RETURN REQUESTS/INQUIRIES

Direct all warranty and repair requests/inquiries to the OMEGA Customer Service Department. BEFORE RETURNING ANY PRODUCT(S) TO OMEGA, PURCHASER MUST OBTAIN AN AUTHORIZED RETURN (AR) NUMBER FROM OMEGA'S CUSTOMER SERVICE DEPARTMENT (IN ORDER TO AVOID PROCESSING DELAYS). The assigned AR number should then be marked on the outside of the return package and on any correspondence.

The purchaser is responsible for shipping charges, freight, insurance and proper packaging to prevent breakage in transit.

FOR **WARRANTY** RETURNS, please have the following information available BEFORE contacting OMEGA:

1. Purchase Order number under which the product was PURCHASED,
2. Model and serial number of the product under warranty, and
3. Repair instructions and/or specific problems relative to the product.

FOR **NON-WARRANTY** REPAIRS, consult OMEGA for current repair charges. Have the following information available BEFORE contacting OMEGA:

1. Purchase Order number to cover the COST of the repair,
2. Model and serial number of the product, and
3. Repair instructions and/or specific problems relative to the product.

OMEGA's policy is to make running changes, not model changes, whenever an improvement is possible. This affords our customers the latest in technology and engineering.

OMEGA is a trademark of OMEGA ENGINEERING, INC.

© Copyright 2017 OMEGA ENGINEERING, INC. All rights reserved. This document may not be copied, photocopied, reproduced, translated, or reduced to any electronic medium or machine-readable form, in whole or in part, without the prior written consent of OMEGA ENGINEERING, INC.

Where Do I Find Everything I Need for Process Measurement and Control? **OMEGA...Of Course!** *Shop online at omega.com*

TEMPERATURE

- ☑ Thermocouple, RTD & Thermistor Probes, Connectors, Panels & Assemblies
- ☑ Wire: Thermocouple, RTD & Thermistor
- ☑ Calibrators & Ice Point References
- ☑ Recorders, Controllers & Process Monitors
- ☑ Infrared Pyrometers

PRESSURE, STRAIN AND FORCE

- ☑ Transducers & Strain Gages
- ☑ Load Cells & Pressure Gages
- ☑ Displacement Transducers
- ☑ Instrumentation & Accessories

FLOW/LEVEL

- ☑ Rotameters, Gas Mass Flowmeters & Flow Computers
- ☑ Air Velocity Indicators
- ☑ Turbine/Paddlewheel Systems
- ☑ Totalizers & Batch Controllers

pH/CONDUCTIVITY

- ☑ pH Electrodes, Testers & Accessories
- ☑ Benchtop/Laboratory Meters
- ☑ Controllers, Calibrators, Simulators & Pumps
- ☑ Industrial pH & Conductivity Equipment

DATA ACQUISITION

- ☑ Communications-Based Acquisition Systems
- ☑ Data Logging Systems
- ☑ Wireless Sensors, Transmitters, & Receivers
- ☑ Signal Conditioners
- ☑ Data Acquisition Software

HEATERS

- ☑ Heating Cable
- ☑ Cartridge & Strip Heaters
- ☑ Immersion & Band Heaters
- ☑ Flexible Heaters
- ☑ Laboratory Heaters

ENVIRONMENTAL MONITORING AND CONTROL

- ☑ Metering & Control Instrumentation
- ☑ Refractometers
- ☑ Pumps & Tubing
- ☑ Air, Soil & Water Monitors
- ☑ Industrial Water & Wastewater Treatment
- ☑ pH, Conductivity & Dissolved Oxygen Instruments