

CE



User's Guide

Shop online at



www.omega.com
e-mail: info@omega.com



FP1400 Digital Paddle Wheel Flow Meter



OMEGAnet® Online Service www.omega.com	Internet e-mail info@omega.com
---	--

Servicing North America:

- USA:**
ISO 9001 Certified
One Omega Drive, Box 4047
Stamford CT 06907-0047
Tel: (203) 359-1660 FAX: (203) 359-7700
e-mail: info@omega.com
- Canada:**
976 Bergar
Laval (Quebec) H7L 5A1
Tel: (514) 856-6928 FAX: (514) 856-6886
e-mail: info@omega.ca

For immediate technical or application assistance:

- USA and Canada:** Sales Service: 1-800-826-6342 / 1-800-TC-OMEGA®
Customer Service: 1-800-622-2378 / 1-800-622-BEST®
Engineering Service: 1-800-872-9436 / 1-800-USA-WHEN®
TELEX: 996404 EASYLINK: 62968934 CABLE: OMEGA
- Mexico:** En Español ol: (001) 203-359-7803 e-mail: espanol@omega.com
FAX: (001) 203-359-7807 info@omega.com.mx

Servicing Europe:

- Benelux:** Postbus 8034, 1180 LA Amstelveen, The Netherlands
Tel: +31 (0)20 3472121 FAX: +31 (0)20 6434643
Toll Free in Benelux: 0800 0993344
e-mail: sales@omegaeng.nl
- Czech Republic:** Rude arm-dy 1868, 733 01 Karvin- 8
Tel: +420 (0)59 6311899 FAX: +420 (0)59 6311114
Toll Free: 0800-1-66342 e-mail: info@omegashop.cz
- France:** 11, rue Jacques Cartier, 78280 Guyancourt, France
Tel: +33 (0)1 61 37 29 00 FAX: +33 (0)1 30 57 54 27
Toll Free in France: 0800 466 342
e-mail: sales@omega.fr
- Germany/Austria:** Daimlerstrasse 26, D-75392 Deckenpfronn, Germany
Tel: +49 (0)7056 9398-0 FAX: +49 (0)7056 9398-29
Toll Free in Germany: 0800 639 7678
e-mail: info@omega.de
- United Kingdom:** One Omega Drive, River Bend Technology Centre
ISO 9002 Certified Northbank, Irlam, Manchester
M44 5BD United Kingdom
Tel: +44 (0)161 777 6611
Toll Free in United Kingdom: 0800-488-48 FAX: +44 (0)161 777 6622
e-mail: sales@omega.co.uk

It is the policy of OMEGA to comply with all worldwide safety and EMC/EMI regulations that apply. OMEGA is constantly pursuing certification of its products to the European New Approach Directives. OMEGA will add the CE mark to every appropriate device upon certification.

The information contained in this document is believed to be correct, but OMEGA Engineering, Inc. accepts no liability for any errors it contains, and reserves the right to alter specifications without notice.

WARNING: These products are not designed for use in, and should not be used for, patient-connected applications.

NOTE: Omega reserves the right to change designs and dimensions at its sole discretion at any time without notice. For certified dimensions please contact Omega®.

TABLE OF CONTENTS

1.	UNPACKING THE FP1400 FLOW METER.....	1
1.1	Inspect Package for External Damage.....	1
1.2	Unpack the FP1400 meter.....	1
1.3	Returning Merchandise for Repair.....	1
2.	FP1400 FLOW METERS TECHNICAL DATA.....	1
2.1	Principles of Operation.....	1
2.2	Electrical Connections.....	2
2.2.1	Power Supply Connections.....	3
2.2.2	Analog Output Signals Connections.....	3
2.2.3	Flow Sensor Pulse Output Signals Connections.....	4
2.2.4	Programmable optically isolated Output Signals Connections.....	5
2.2.5	Communication Parameters and Connections.....	6
2.3	FP1400 Flow Meter Specification.....	7
2.4	FP1400 Maintenance.....	9
2.4.1	Sensors.....	9
2.4.2	FP1400 Paddle Wheel Disassembly.....	9
3.	LCD KEYPAD OPERATION: DATA ENTRY AND CONFIGURATION.....	11
3.1	Display Indications (applicable for LCD options only).....	11
3.1.1	FP1400 with RTD option Process Information Screens.....	12
3.1.2	FP1400 without RTD option Process Information Screens.....	14
3.2	Menu Sequence.....	15
3.3	Parameter Summary and Data Entry.....	17
4.	PARAMETER ENTRY.....	25
4.1	Submenu Program protection.....	25
4.2	Submenu Flow Meter Info.....	26
4.2.1	Full Scale Flow.....	26
4.2.2	Communication Interface.....	26
4.2.3	RTD hardware option.....	27
4.2.4	Analog Flow Output settings.....	27
4.2.5	Analog Temperature Output settings.....	27
4.2.6	Flow Meter EEPROM data base version.....	28
4.2.7	Flow Meter Firmware version.....	28
4.2.8	Flow Meter Serial number.....	28
4.2.9	Flow Meter Model number.....	28
4.2.10	Fluid Name.....	29
4.2.11	Flow Meter Calibration Date.....	29
4.2.12	Flow Meter Calibration Date Due.....	29
4.2.13	Flow Meter User Tag Name.....	29

4.3	Submenu Measuring Units.....	30
4.3.1	User Defined Measuring Unit.....	32
4.3.1.a	User Defined Unit Factor Numeric entry.....	32
4.3.1.b	User Defined Unit Time Base Tabular entry.....	32
4.3.1.c	User Defined Unit Density support Tabular entry.....	33
4.4	Submenu Flow Alarm.....	33
4.4.1	Flow Alarm Mode Tabular entry.....	33
4.4.2	Low Flow Alarm Numerical entry.....	34
4.4.3	High Flow Alarm Numerical entry.....	34
4.4.4	Flow Alarm Action Delay Numerical entry.....	35
4.4.5	Flow Alarm Action Latch Tabular entry.....	35
4.5	Submenu Temperature Alarm (*optional).....	36
4.5.1	Temperature Alarm Mode Tabular entry.....	36
4.5.2	Low Temperature Alarm Numerical entry.....	36
4.5.3	High Temperature Alarm Numerical entry.....	37
4.5.4	Temperature Alarm Action Delay Numerical entry.....	38
4.5.5	Temperature Alarm Action Latch Tabular entry.....	38
4.6	Submenu Main Totalizer.....	39
4.6.1	Main Totalizer Mode Tabular entry.....	39
4.6.2	Main Totalizer Flow Start Numerical entry.....	40
4.6.3	Main Totalizer Event Volume Numerical entry.....	40
4.6.4	Main Totalizer Reset Tabular entry.....	40
4.7	Submenu Pilot Totalizer.....	41
4.7.1	Pilot Totalizer Mode Tabular entry.....	41
4.7.2	Pilot Totalizer Flow Start Numerical entry.....	42
4.7.3	Pilot Totalizer Event Volume Numerical entry.....	42
4.7.4	Pilot Totalizer Reset Tabular entry.....	42
4.8	Submenu Optical Outputs Numerical entry.....	43
4.9	Submenu Flow Meter Configuration.....	44
4.9.1	Submenu Flow Meter Low Flow Cut-off Numerical entry.....	44
4.9.2	Submenu Pulse Number Measure Interval Numerical entry.....	44
4.9.3	Submenu Flow Meter Calibration Factor Numerical entry.....	45
4.9.4	Submenu Flow Meter Measure Mode Tabular entry.....	45
4.9.5	Submenu Noise Reduction Filter Damping Time Numerical entry.....	46
4.9.6	Submenu Noise Reduction Filter Sample Number Numerical entry.....	46
4.9.7	Submenu Flow Linearizer Tabular entry.....	47
4.9.8	Submenu Fluid Density Numerical entry.....	47
4.9.9	Submenu Pilot Calibration timer Tabular entry.....	47
4.10	Submenu LCD Back Light Numerical Entry.....	48
4.11	Submenu Alarm Events Log.....	48
4.11.1	Submenu Alarm Events Log Status.....	50
4.11.2	Submenu Alarm Events List.....	51
4.11.3	Submenu Alarm Events Log Mask.....	51
4.12	Submenu Diagnostic.....	51

4.12.1	Submenu Raw Pulses Count.....	52
4.12.2	Submenu Pulse Frequency.....	52
4.12.3	Submenu Raw RTD reading (RTD option only).....	52
4.12.4	Submenu DAC_A Flow Output.....	52
4.12.5	Submenu DAC_B Temperature Output.....	53
4.12.6	Submenu CPU Temperature.....	53
4.12.7	Submenu Raw VCC Reading.....	53
5.	ANALOG OUTPUT SIGNALS.....	53
5.1	Analog Output Signals configuration.....	53
5.2	Analog Output Signals calibration.....	54
5.2.1	Initial Setup.....	55
5.2.2	Flow 0-5 Vdc analog output calibration.....	56
5.2.3	Flow 4-20 mA analog output calibration.....	56
5.2.4	Temperature 0-5 Vdc analog output calibration*.....	57
5.2.5	Temperature 4-20 mA analog output calibration*.....	57
6.	FP1400 FLOW CALIBRATION PROCEDURES.....	58
6.1	Connections and Initial Warm Up.....	58
6.2	Flow Meter Span Calibration.....	59
6.3	Flow Meter Linearization Table Calibration.....	59
7.	RS485/RS232 SOFTWARE INTERFACE COMMANDS.....	61
7.1	General.....	61
7.2	Commands Structure.....	61
7.3	ASCII Commands Set.....	63
8.	TROUBLESHOOTING.....	71
8.1	Common Conditions.....	71
APPENDIX I	FP1400 EEPROM Variables.....	73
APPENDIX II	Component Diagram Top Side.....	76
	Component Diagram Bottom Side.....	76
APPENDIX III	Dimensional Drawing.....	77

1. UNPACKING THE FP1400

1.1 Inspect Package for External Damage

Remove the Packing List and verify that you have received all equipment. If you have any questions about the shipment, please call the Omega® Customer Service Department at 1-800-622-2378 or (203) 359-1660. Your FP1400 Paddle Wheel Meter was carefully packed in a sturdy cardboard carton, with anti-static cushioning materials to withstand shipping shock. Upon receipt, inspect the package for possible external damage. In case of external damage to the package contact the shipping company immediately.

1.2 Unpack the FP1400 Meter

Open the carton carefully from the top and inspect for any sign of concealed shipping damage. In addition to contacting the shipping carrier please forward a copy of any damage report to Omega® directly. When unpacking the instrument please make sure that you have all the items indicated on the Packing List. Please report any shortages promptly.

1.3 Returning Merchandise for Repair

Please contact an Omega® customer service representative and request a Return Authorization Number (AR). It is mandatory that any equipment returned for servicing be purged and neutralized of any dangerous contents including but not limited to toxic, bacterially infectious, corrosive or radioactive substances. No work shall be performed on a returned product unless the customer submits a fully executed, signed SAFETY CERTIFICATE. Please request form from the Service Manager.

2. FP1400 FLOW METERS TECHNICAL DATA

2.1 Principles of Operation

FP1400 liquid flow meters consist of a meter body that is installed in-line in a conduit system. Inside, between the inlet and the outlet connections is a rotary wheel with permanent magnets embedded at 180 degrees in paddles.

Fluid flowing through the meter causes the paddle to spin. A magnetic sensor picks up the frequency of pulses, and the readings are proportional to the liquid flow taking place. The number of pulses per unit time interval and a K-factor (pulses/unit of flow) facilitate determining the volumetric rate of flow through the meter.

Additionally, the FP1400 Flow Meter incorporates a Microcontroller driven circuitry and non-volatile memory that stores all hardware specific variables. The flow rate can be displayed in 29 different volumetric or mass flow engineering units. Flow meter parameters and functions can be programmed remotely via the RS232/RS485 interface or locally via optional LCD/KeyPad. FP1400 flow meters support various functions including: two programmable flow totalizers, low, high or range flow and temperature* alarms, 2 programmable optically isolated outputs, 0-5 Vdc / 4-20 mA analog outputs (jumper selectable) for each process (flow and temperature*) variable, self diagnostic alarm. Optional local 2x16 LCD* read-out with adjustable back light provides flow rate, temperature*, total volume reading in currently selected engineering units, diagnostic events indication and feature a password protected access to the process parameters to ensure against tampering or resetting.

2.2 Electrical Connections

FP1400 flow meter is supplied with "M16" cylindrical 12 pin connector. Pin diagram is presented in figure b-1.

PIN	FP1400 FUNCTION	TYPE
A	Plus Power Supply (+ DC power 11 to 26 Vdc)	+Power
B	Minus Power Supply, (- DC power 11 to 26 Vdc), Digital Common	-Power, Common
C	Flow Sensor Pulse Output (active), 3.3Vdc 3K min. load impedance	Output Only
D	Digital Communication interface, RS485 (-) (Optional RS232 TX)	Input /Output
E	Digital Communication interface, RS485 (+) (Optional RS232 RX)	Input /Output
F	Optical Output No.1 Plus (+) (passive)	Input
G	Optical Output No.1 Minus (-) (passive)	Return for Pin F
H	Optical Output No.2 Plus (+) (passive)	Input
J	Optical Output No.2 Minus (-) (passive)	Return for Pin H
K	Common, Analog Signal Ground For Pins L & M, (4-20 mA return)	Signal Common
L	Temp. Analog Output Plus (+) 0-5 Vdc or 4-20 mA, jmp. selectable	Output Only
M	Flow Analog Output Plus (+), 0-5 Vdc or 4-20 mA, jmp. selectable	Output Only

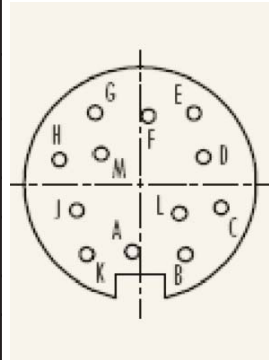
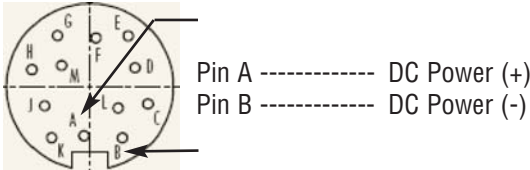

Figure b-1, FP1400 12 Pin "M16" Connector Configuration

2.2.1 Power Supply Connections

The power supply requirements for FP1400 flow meter are: 11 to 26 Vdc 100 mV maximum peak to peak output noise, (unipolar power supply).



CAUTION: Do not apply power voltage above 26Vdc. Doing so will cause FP1400 damage or faulty operation.



Make sure power is OFF when connecting or disconnecting any cables in the system.

The (+) and (-) power inputs are each protected by a 300mA M (medium time-lag) resettable fuse. If a shorting condition or polarity reversal occurs, the fuse will cut power to the flow transducer circuit. Disconnect the power to the unit, remove the faulty condition, and reconnect the power. The fuse will reset once the faulty condition has been removed.

Use of the FP1400 flow meter in a manner other than that specified in this manual or in writing from Omega®, may impair the protection provided by the equipment.

2.2.2 Analog Output Signals Connections



CAUTION: When connecting the load to the output terminals, do not exceed the rated values shown in the specifications. Failure to do so might cause damage to this device. Be sure to check if the wiring and the polarity of the power supply is correct before turning the power ON. Wiring error may cause damage or faulty operation.

FP1400 series Flow Meters are equipped with either calibrated 0-5 or calibrated 4-20 mA output signals (jumper selectable). This linear output signal represents 0-100% of the flow meter's full scale range.



WARNING: The 4-20 mA current loop output is self-powered (sourcing type, non-isolated). Do NOT connect an external voltage source to the output signals.



WARNING: Observe jumper configuration before connecting 4-20 mA current loop load. Failure to make proper jumper configuration (see Figure 5-1) may cause damage for output circuitry. Do NOT connect an external voltage source to the output signals.

Flow 0-5 VDC or 4-20 mA output signal connection:

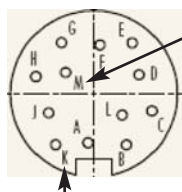

Pin M ----- (+) Plus Flow Analog Output
Pin K ----- (-) Minus Flow Analog Output

Temperature 0-5 VDC or 4-20 mA output signal connection (optional):

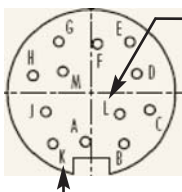

Pin L ----- (+) Plus Temperature Analog Output
Pin K ----- (-) Minus Temperature Analog Output

To eliminate the possibility of noise interference, use a separate cable entry for the DC power and analog signal lines (pins L, M, K on “M16” connector).

2.2.3 Flow Sensor Pulse Output Signals Connections

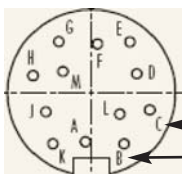

Pin C ----- (+) Flow Sensor Pulse Output (active), 3.3Vdc
Pin B ----- DC Power (-), Digital Common



WARNING: The flow sensor pulse output is self-powered (open drain, pulled up with 10K resistor to internal 3.3Vdc rail). Do NOT connect an external voltage source to the pulse output signals. Use load with input impedance more than 30K is recommended.

2.2.4 Programmable optically isolated Output Signals Connections

Optocoupler #1 (pins F and G):

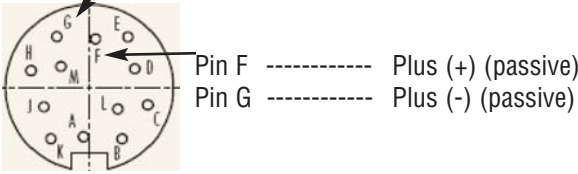

Optocoupler #2 (pins H and J):

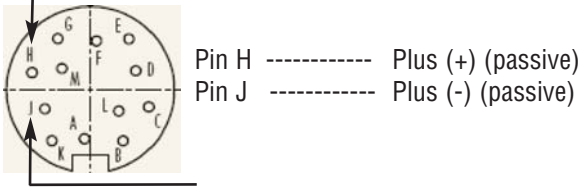

WARNING: Optically isolated outputs require application of DC voltage across terminals. Do not exceed maximum allowed limits for voltage and current provided below:

Digital Output Optocoupler

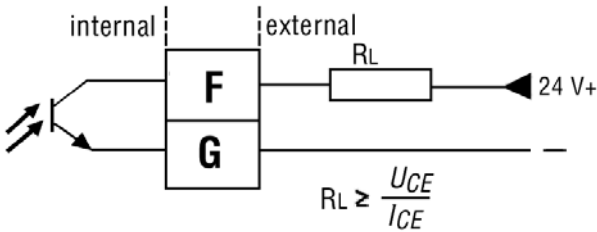

2.2.5 Communication Parameters and Connections

The digital interface operates via RS485 (optional RS232) and provides access to applicable internal data including: flow, temperature, totalizers and alarm settings, flow linearizer table, fluid density and engineering units selection.

Communication Settings for RS485/RS232 communication interface:

Baud rate:	-----	9600 baud
Stop bit:	-----	1
Data bits:	-----	8
Parity:	-----	None
Flow Control:	-----	None

RS485 communication interface connection:

The RS485 converter/adaptor must be configured for: multidrop, 2 wire, half duplex mode. The transmitter circuit must be enabled by TD or RTS (depending on which is available on the converter/adaptor). Settings for the receiver circuit should follow the selection made for the transmitter circuit in order to eliminate echo.

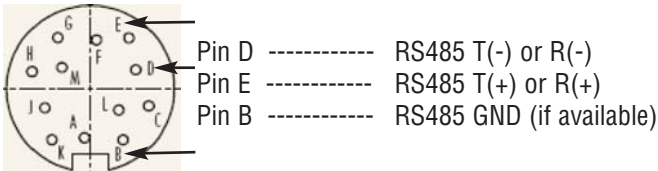

RS232 communication interface connection:

Crossover connection has to be established:



2.3 FP1400 Flow Meter Specification

FLOW MEDIUM: Please note that FP1400 Flow Meters are designed to work only with liquids. Never try to measure flow rates of dry gas.

CALIBRATIONS: Performed at standard conditions [14.7 psia (101.4 kPa) and 70 °F (21.1 °C)] unless otherwise requested or stated.

VISCOSITY: Calibrated to 1 cPoise (water). Meters can be used for fluids up to 50 cPoise with field calibration (maximum flow range may be affected).

ENVIRONMENTAL (PER IEC 664): Installation Level II; Pollution Degree II.

FLOW ACCURACY (INCLUDING LINEARITY): $\pm 1\%$ of FS.

REPEATABILITY: $\pm 0.25\%$ of full scale.

TEMPERATURE ACCURACY (INCLUDING LINEARITY)*: ± 0.5 °C.

FLOW RESPONSE TIME: Approximately 1 seconds (above 10% of full scale flow), approximately 2 seconds (below 10% of full scale flow).

MAXIMUM PRESSURE: 10 bar (150 psi).

MAXIMUM PRESSURE DROP: See Table 2.3.1 for pressure drops associated with various models and flow rates.

FLUID AND AMBIENT TEMPERATURE: 14 °F to 140 °F (-10 °C to 60 °C).

OUTPUT SIGNALS: Linear 0-5 Vdc (3000 ohms min load impedance);
Linear 4-20 mA (500 ohms maximum loop resistance).
Maximum noise 20mV peak to peak (for 0-5 Vdc output).
Flow Pulse Output: 3.3 Vdc amplitude (3000 ohms min load impedance).

OPTICALLY ISOLATED OUTPUTS: UCE 40Vdc, ICE 150 mA.

FLOW METER INPUT POWER: 11 to 26 Vdc, 100 mV maximum peak to peak output noise. Power consumption: +12Vdc (150 mA maximum); +24Vdc (100 mA maximum); Circuit board have built-in polarity reversal protection, 300mA resettable fuse provide power input protection.

COMMUNICATIONS PARAMETERS (RS232/RS485):

Baud rate: 9600 baud
 Stop bit: 1
 Data bits: 8
 Parity: None
 Flow Control: None

DISPLAY*: Optional local 2x16 characters LCD with adjustable backlight (2 lines of text).

KEY PAD*: Optional 4 push button key pad.

CE COMPLIANCE: EMC Compliance with 89/336/EEC as amended. Emission Standard: EN 55011:1991, Group 1, Class A Immunity Standard: EN 55082-1:1992

(* - optional feature)

Table 2.3.1 FP1400 Flow Meter Flow Ranges and Pressure Drop

FLOW RATE FOR FP1400					
METER SIZES	FLOW RATE H ₂ O		INLET/OUTLET PORTS FEMALE NPT	MAXIMUM PRESSURE DROP	
	[L/min]	Gal/min		Bar	PSI
FP1402 /FP1412/ FP1402-RTD /FPR1412-RTD	0.15-18.9	0.04-5	3/8"	1	15
FP1404 /FP1414/ FP1404-RTD /FP1414-RTD	0.3-37.6	0.08-10	1/2"	1.4	20
FP1406 /FP1416/ FP1406-RTD /FP1416-RTD	0.6-64.4	0.15-17	3/4"	1.4	20
FP1408 /FP1418/ FP1408-RTD /FP1418-RTD	1.3-132.5	0.35-35	1"	1.4	20

Table 2.3.2 FP1400 Flow Meter wetted materials

WETTED MATERIALS		
	POLYPROPYLENE MODELS	PVDF MODELS
BODY	Polypropylene	PVDF
LID	Acrylic	PVDF
PADDLE WHEEL	PVDF Nickel Tungsten Carbide	PVDF Zirconia Ceramic
BEARINGS	Sapphire Jewels	Sapphire Jewels
O-RINGS	EPDM	PTFE
PLATINUM RTD	316 stainless steel casing	316 stainless steel casing

2.4 FP1400 MAINTENANCE



CAUTION: Some of the IC devices used in the flow meter signal conditioning circuitry are static sensitive and may be damaged by improper handling. When adjusting or servicing the signal converter, use of a grounded wrist strap is recommended to prevent inadvertent damage to the integral solid state circuitry. The flow meter signal conditioning circuitry uses complex electronic circuit components. Generally, due to the complexity of troubleshooting integrated circuit devices, maintenance beyond the PCB assembly level is not recommended. Also, caution must be used when connecting test probes, as even a momentary accidental short circuit may damage or destroy an integrated circuit device.

2.4.1 Sensors

In rare instances, due to electrical damage, the pulse sensor or RTD need to be replaced by disconnecting the signal cable connector from the PCB and unscrewing it and installing a replacement. This procedure can be done only by factory authorized personnel.

2.4.2 FP1400 Paddle Wheel and Bearings Replacement

To replace the paddle wheel, disconnect the meter from electrical and liquid lines. Unscrew 4 screws that hold the lid in place. Remove the lid by lifting it up and move the wheel out. The Wheel's embedded shaft is supported at each end by sapphire bearings to minimize friction and facilitate very low flow rate measurements (see Figure 2-1). Reassembly is made ensuring that the shaft end is inserted gently into the bottom bearing. Check to see if the wheel is free to spin before the lid is installed. Gently put the lid over the opening and gently spin it by hand until the upper bearing, installed in the lid, drops into the place. Hold the lid down and check for free spinning by lightly blowing into the port; or lightly shake and listen if both shaft ends got into the bearings. Make sure the O-ring is in its seat, insert four cap screws and gradually tighten them. Bearings are made of sapphire, which rarely needs replacement, unless they were physically shattered. Bearings highly susceptible to careless disassembly and reassembly practices. While the unit is disassembled for paddle wheel replacement, bearing could be replaced with bear-



CAUTION: Never use compressed air or gases to test the meter, as this would damage the Bearings.

PARTS LIST

	PARTS	FP1400 MATERIALS	FP1400 MATERIALS
1	LOWER BLOCK	POLYPROPYLENE	PVDF
2	JEWEL BEARING (2 required)	PVDF SAPPHIRE	
3	PADDLE WHEEL	PVDF & NICKEL TUNGSTEN CARBIDE	PVDF & ZIRCONIA CERAMIC
4	LID	ACRYLIC	PVDF
5	JUMPER COMPARTMENT PLUG	POLYPROPYLENE	
6	SCREW 8-32 (4 required)	STAINLESS STEEL	
7	O-RING	EPDM	PTFE
8	SCREW 6-32	STAINLESS STEEL	

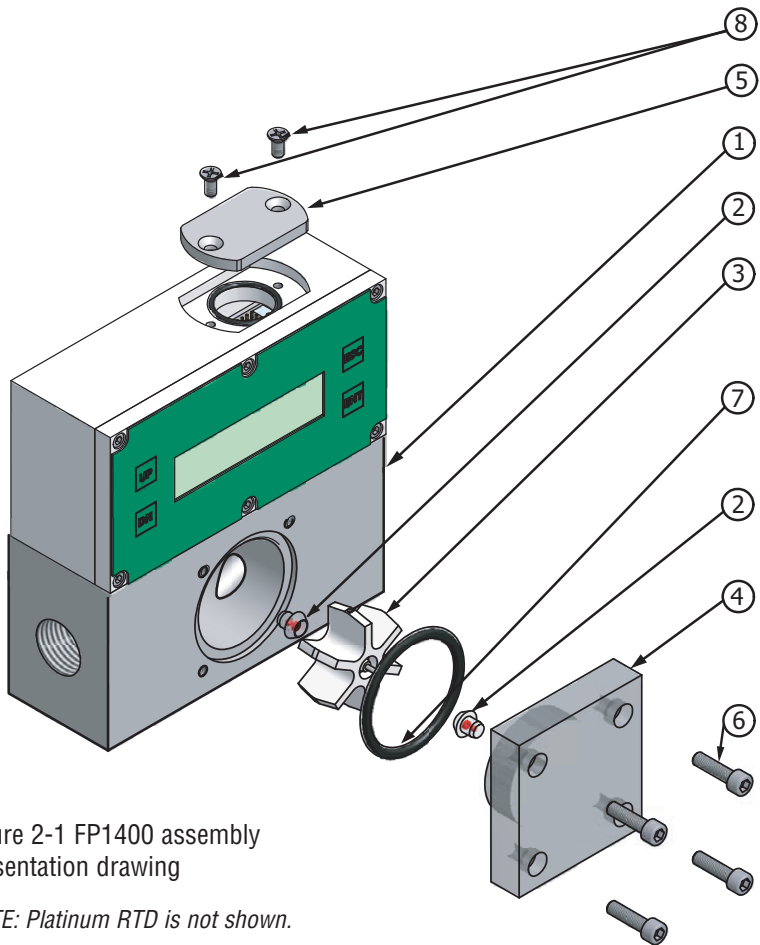

Figure 2-1 FP1400 assembly presentation drawing

NOTE: Platinum RTD is not shown.

3. LCD KEYPAD OPERATION: DATA ENTRY AND CONFIGURATION (applicable for LCD options only)

3.1 Display Indications

Initially, after the power is first turned on, the flow meter model number is shown in the first line of the display and the revisions for EPROM table and firmware in the second line. Subsequently the actual process information is displayed. The instantaneous flow rate is displayed on the first line in percent or in direct reading units with flow alarm status indication. For flow meters without RTD option, the main totalizer value, up to 9 digits (including decimal), is displayed in the second line with its corresponding units.

For flow meters with RTD option, the temperature reading value in deg C, is displayed in the second line with temperature alarm status indication. This display is designated as process information (PI) screen throughout the remainder of this manual.

The temperature value (applicable for RTD option only) in deg F can be displayed in the PI screen by pressing the ENT pushbutton. The temperature indication can be switched from deg C to deg F and back by pressing ENT pushbutton.

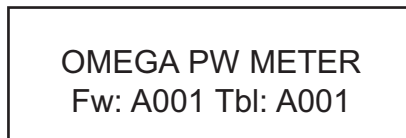

Figure 3.1: FP1400 first Banner Screen

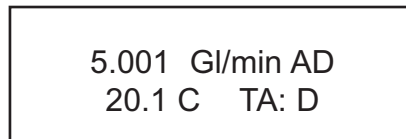

Figure 3.2: FP1400 with RTD option initial Process Information Screen



Note: Actual content of the LCD screen may vary depending on the model and device configuration.



Figure 3.3: FP1400 without RTD option initial Process Information Screen

Based on flow meter configuration (with or without RTD option), different parameters may be displayed in the PI screen by pressing the UP or DN pushbuttons.

3.1.1 FP1400 with RTD option Process Information Screens

Pressing UP and DN buttons from initial PI screen will switch display as following:

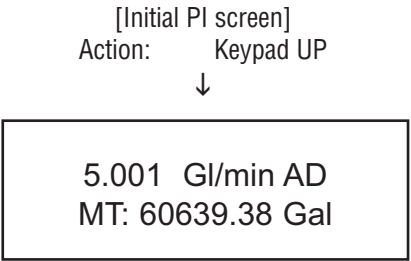

Figure 3.4: FP1400 with RTD option Process Information Screen with Main Totalizer

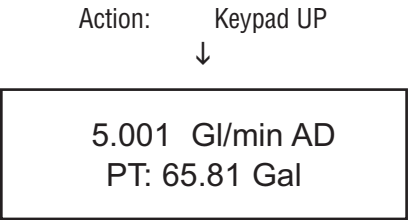

Figure 3.5: FP1400 with RTD option Process Information Screen with Pilot Totalizer

Action: Keypad UP



5.001 G/min AD
20.1 C *****Gal

Figure 3.6: FP1400 with RTD option PI Screen with flow range, temperature and Main Totalizer

Action: Keypad UP



MT: 60639.38 Gal
20.1 C 65.81 Gal

Figure 3.7: FP1400 with RTD option PI Screen with Main Totalizer, temperature and Pilot Totalizer

Action: Keypad UP



MT: 60639.38 Gal
PT: 65.81 Gal

Figure 3.8: FP1400 with RTD option PI Screen with Main and Pilot Totalizers

Action: Keypad UP



5.001 Gl/min AD
20.1 C TA: D

Figure 3.9: FP1400 with RTD option initial Process Information Screen

Pressing UP button, pages through the PI screens in the forward direction. Pressing DN button, pages through the PI screens in the reverse direction. When the last PI screen is reached, the firmware "wraps around" and scrolls to the initial PI screen once again.

3.1.2 FP1400 without RTD option Process Information Screens

Pressing UP and DN buttons from initial PI screen will switch display as following:

[Initial PI screen]
Action: Keypad UP



5.001 Gl/min AD
PT: 65.81 Gal

Figure 3.10: FP1400 without RTD option PI Screen with Main and Pilot Totalizer

Action: Keypad UP



MT: 60639.38 Gal
PT: 65.81 Gal

Figure 3.11: FP1400 without RTD option initial PI Screen with Main and Pilot Totalizer

Action: Keypad UP



5.001 GI/min AD MT: 60639.38 Gal

Figure 3.12: FP1400 without RTD option initial PI Screen with Flow rate and Main Totalizer

3.2 Menu Sequence

The listing below gives a general overview of the standard top-level display menu sequence when running firmware version A002. The ESC pushbutton is used to toggle between the process mode (PI screens) and the menu.

The listing in Section 3.2 shows the standard display menu sequence and sub-menus using the UP button to move through the menu items. The first message displayed the first time the ESC button is pressed after the converter is powered up is "Prog. Protection ON". Thereafter, pressing the ESC button while the flow meter is in monitoring mode (PI screens) will display the parameter that was last exited.

Program Protection may be turned "off" by pressing the ENT button when the Prog. Protection menu is displayed. The firmware will prompt with "Change Prog Prot". Pressing UP or DN button will toggle current protection status. If password is set to any value more than zero, the firmware will prompt with "Enter Prot Code". User has to enter up to 3 digits program protection code, in order to be able to access password protected menus. Once correct password is entered, program protection id turned off until unit is powered up again.

When the last menu item is reached, the firmware "wraps around" and scrolls to the first item on the menu once again (see Figure 3.12). The menu items in the first column are upper-level configuration mode functions. Submenu selections (shown indented in the second column) only appear if the associated upper level is selected by pressing the ENT push button. The allowable selections of submenu items which are selected by tabular means are shown in detail in Section 3.3

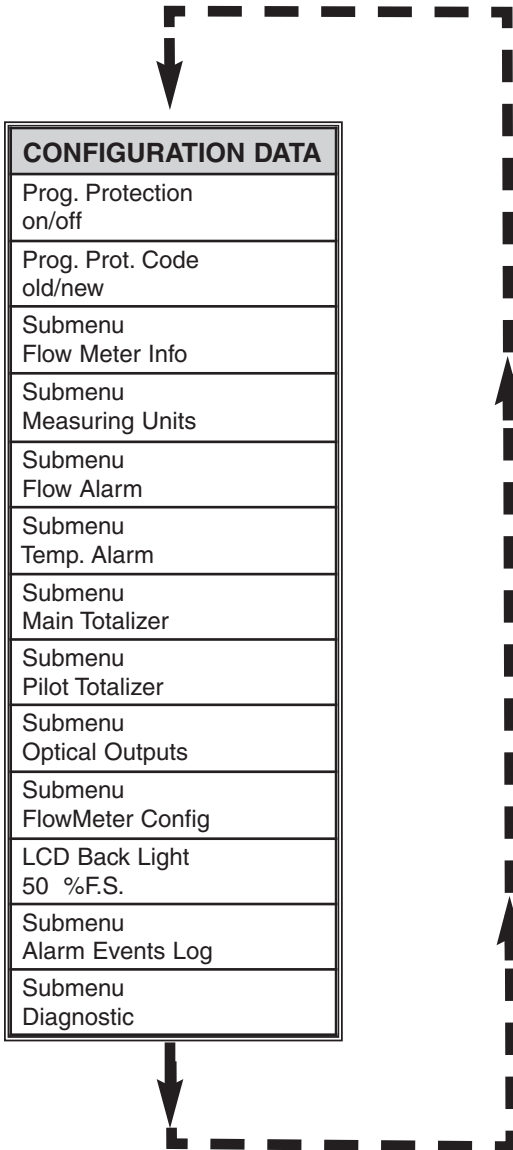

Figure 3.12 Upper level menu structure.

3.3 Parameter Summary and Data Entry

Submenu / Parameter	Entry mode	Description
<div style="border: 1px solid black; padding: 2px; width: fit-content;"> Prog. Protection off </div>	tabular/numeric	<p>Data entry is only possible by turning "Prog. Protection" off. When initially powered-up, "Prog. Protection" is "ON".</p>
<div style="border: 1px solid black; border-radius: 50%; width: 30px; height: 30px; display: flex; align-items: center; justify-content: center;"> ENT </div>	<div style="border: 1px solid black; padding: 2px; width: fit-content;"> Prog. Protection off </div>	on/off
	<div style="border: 1px solid black; padding: 2px; width: fit-content;"> PP-code? 0 </div>	<p>If a different program protection code (1-255) than "0" was entered (factory entry), this code must be entered first in order to turn off the program protection.</p>
	<div style="border: 1px solid black; padding: 2px; width: fit-content;"> Prog. Protection off </div>	<p>Once Program Protection has been turned off, parameters may be changed.</p>
<div style="border: 1px solid black; padding: 2px; width: fit-content;"> Prog. Protection Code ----- </div>	numeric	<p>After the Program Protection has been turned off the Program Protection code can be changed.</p>
<div style="border: 1px solid black; border-radius: 50%; width: 30px; height: 30px; display: flex; align-items: center; justify-content: center;"> ENT </div>	<div style="border: 1px solid black; padding: 2px; width: fit-content;"> Old PP Code? -- 0 </div>	<p>Enter old Program Protection code. 0 = factory entry.</p>
	<div style="border: 1px solid black; padding: 2px; width: fit-content;"> New PP Code: -- off </div>	<p>Enter new program protection code (0-255).</p>

Submenu / Parameter	Entry mode	Description
Sub Menu Flow Meter Info	Full Scale Flow: 18.92706 L/min	<div style="display: flex; align-items: center;"> <div style="border: 1px solid black; border-radius: 50%; padding: 2px 5px; margin-right: 10px;">ESC</div> <div>Exit submenu</div> </div> Read-only parameter.
ENT	Comm. Interface: RS-485 ADD:11	Read-only parameter.
	RTD Option: Installed	Read-only parameter.
	Analog Flow Out: 0-5 Vdc	Read-only parameter.
	Analog Temp Out: 0-5 Vdc	Read-only parameter.
	EEPROM Version: A002	Read-only parameter.
	Firmware Version: A001	Read-only parameter.
	Serial Number: 285024-1	Read-only parameter.
	Model Number: FP1400-ELR-A4	Read-only parameter.
	Fluid Name: WATER	Read-only parameter.
	Calibration Date: 22-JUL--09	Read-only parameter.
	Calib. Date Due: 22-JUL-10	Read-only parameter.

Submenu / Parameter	Entry mode	Description
Sub Menu Measuring Units	<div style="border: 1px solid black; padding: 5px; text-align: center;">User Tag Name: NOT ASSIGNED</div>	Read-only parameter.
	<div style="text-align: right; margin-bottom: 5px;">Select Menu</div> <div style="border: 1px solid black; padding: 5px; text-align: center;">Flow Range Units Gl/min</div> <div style="text-align: right; margin-bottom: 5px;">Select Unit</div> <div style="border: 1px solid black; padding: 5px; text-align: center;">Enter Flow Units: Gl/min</div> <div style="display: flex; justify-content: center; gap: 10px; margin-top: 5px;"> (UP) (DN) Change Units </div>	<p>(ESC) Exit submenu</p> <p>(ESC) Exit Unit Selection</p> <p>Tabular Entry</p> <p><small>% , mL/sec, mL/min, mL/hr, L/sec, L/min, L/hr, m3/sec, m3/min, m3/hr, l3/sec, l3/min, l3/hr, g/sec, g/min, g/hr, kg/sec, kg/min, kg/hr, Lb/sec, Lb/min, Lb/hr, GI/sec, GI/min, Gal/hr, t/sec, t/min, t/hr, USER (user defined)</small></p>
Sub Menu Flow Alarm	<div style="text-align: right; margin-bottom: 5px;">Select Menu</div> <div style="border: 1px solid black; padding: 5px; text-align: center;">Flow Alarm Mode Disabled</div> <div style="text-align: center; margin-bottom: 5px;">(UP)</div> <div style="text-align: right; margin-bottom: 5px;">Select Menu</div> <div style="border: 1px solid black; padding: 5px; text-align: center;">Low Flow Alarm 10.0%F.S.</div> <div style="text-align: center; margin-bottom: 5px;">(UP)</div> <div style="text-align: right; margin-bottom: 5px;">Select Menu</div> <div style="border: 1px solid black; padding: 5px; text-align: center;">High Flow Alarm 90.0 %F.S.</div> <div style="text-align: center; margin-bottom: 5px;">(UP)</div> <div style="text-align: right; margin-bottom: 5px;">Select Menu</div> <div style="border: 1px solid black; padding: 5px; text-align: center;">Flow Alarm Delay 1 Second</div> <div style="text-align: center; margin-bottom: 5px;">(UP)</div> <div style="text-align: right; margin-bottom: 5px;">Select Menu</div> <div style="border: 1px solid black; padding: 5px; text-align: center;">Flow Alarm Latch Disabled</div>	<p>Change Mode Select Mode Exit Mode Selection</p> <p>(UP) (DN) (ENT) (ESC)</p> <p>Numerical Entry</p> <p>Change Value Next Digit Select New Value Exit Low Flow Alarm Selection</p> <p>(UP) (DN) (ENT) (ESC)</p> <p>Numerical Entry</p> <p>Change Value Next Digit Select New Value Exit High Flow Alarm Selection</p> <p>(UP) (DN) (ENT) (ESC)</p> <p>Numerical Entry</p> <p>Change Value Next Digit Select New Value Exit Flow Alarm Delay Selection</p> <p>(UP) (DN) (ENT) (ESC)</p> <p>Tabular Entry</p> <p>Change Mode Select Mode Exit Mode Selection</p> <p>(UP) (DN) (ENT) (ESC)</p>

Submenu / Parameter	Entry mode	Description			
<div style="border: 1px solid black; padding: 5px; text-align: center;">Sub Menu Temp. Alarm</div>	<div style="border: 1px solid black; padding: 5px; text-align: center;">Temp Alarm Mode Disabled</div>	<p style="text-align: center;">Tabular Entry</p> <p>Change Mode Select Mode Exit Mode Selection</p> <p style="text-align: center;">(UP) (DN) (ENT) (ESC)</p>			
		<div style="border: 1px solid black; padding: 5px; text-align: center;">Low Temp Alarm 0.0 C</div>	<p style="text-align: center;">Numerical Entry</p> <p>Change Value Next Digit Select New Value Exit Low Temp Alarm Selection</p> <p style="text-align: center;">(UP) (DN) (ENT) (ESC)</p>		
		<div style="border: 1px solid black; padding: 5px; text-align: center;">High Temp Alarm 50.0 C</div>	<p style="text-align: center;">Numerical Entry</p> <p>Change Value Next Digit Select New Value Exit High Temp Alarm Selection</p> <p style="text-align: center;">(UP) (DN) (ENT) (ESC)</p>		
		<div style="border: 1px solid black; padding: 5px; text-align: center;">Temp Alarm Delay 0 Second</div>	<p style="text-align: center;">Numerical Entry</p> <p>Change Value Next Digit Select New Value Exit Temp Alarm Delay Selection</p> <p style="text-align: center;">(UP) (DN) (ENT) (ESC)</p>		
		<div style="border: 1px solid black; padding: 5px; text-align: center;">Temp Alarm Latch Disabled</div>	<p style="text-align: center;">Tabular Entry</p> <p>Change Mode Select Mode Exit Mode Selection</p> <p style="text-align: center;">(UP) (DN) (ENT) (ESC)</p>		
		<div style="border: 1px solid black; padding: 5px; text-align: center;">Sub Menu Main Totalizer</div>	<div style="border: 1px solid black; padding: 5px; text-align: center;">Main Total Mode Disabled</div>	<p style="text-align: center;">Tabular Entry</p> <p>Change Mode Select Mode Exit Mode Selection</p> <p style="text-align: center;">(UP) (DN) (ENT) (ESC)</p>	
				<div style="border: 1px solid black; padding: 5px; text-align: center;">MT Flow Start 5.0 %F.S.</div>	<p style="text-align: center;">Numerical Entry</p> <p>Change Value Next Digit Select New Value Exit MT Flow Start Selection</p> <p style="text-align: center;">(UP) (DN) (ENT) (ESC)</p>
				<div style="border: 1px solid black; padding: 5px; text-align: center;">MT Event Volume 0.0 Gal</div>	<p style="text-align: center;">Numerical Entry</p> <p>Change Value Next Digit Select New Value Exit MT Event Volume Selection</p> <p style="text-align: center;">(UP) (DN) (ENT) (ESC)</p>

Submenu / Parameter	Entry mode	Description
	Select Menu Reset Main Total Value? (ENT)	For 2 seconds only Press ENT Key to reset Totalizer! (ENT) Reset Totalizer
Sub Menu Pilot Totalizer (ENT)	Select Menu Pilot Total Mode Disabled (ENT) UP Select Menu PT Flow Start 10.0 %F.S. (ENT) UP Select Menu PT Event Volume 0.0 Gal (ENT) UP Select Menu Reset Pilot Total Value? (ENT)	Tabular Entry Change Mode Select Mode Exit Mode Selection (UP) (DN) (ENT) (ESC) Numerical Entry Change Value Next Digit Select New Value Exit PT Flow Start Selection (UP) (DN) (ENT) (ESC) Numerical Entry Change Value Next Digit Select New Value Exit PT Event Volume Selection (UP) (DN) (ENT) (ESC) For 2 seconds only Press ENT Key to reset Totalizer! (ENT) Reset Totalizer
Sub Menu Optical Outputs (ENT)	Select Menu Opt #1 Function Disabled (ENT) UP Select Menu Opt #2 Function Disabled (ENT)	Tabular Entry Change Function Select Function Exit Function Selection (UP) (DN) (ENT) (ESC) Change Function Select Function Exit Function Selection (UP) (DN) (ENT) (ESC) Following Function Settings are available: Disabled Low F. Alarm High F. Alarm F. Range H-L M Total Event P Total Event Low T. Alarm High T. Alarm T. Range H-L Diagnostic Manual On

Submenu / Parameter	Entry mode	Description
<div style="border: 1px solid black; padding: 5px; width: fit-content; margin: 0 auto;">Sub Menu Flow Meter Config</div>	<div style="text-align: center;"> Select Menu <div style="border: 1px solid black; padding: 5px; display: inline-block;">Low Flow Cut-off 1.000 %F.S.</div> ENT </div>	Numerical Entry Change Value: UP Next Digit: DN Select New Value: ENT Exit Low Flow Cut off Selection: ESC
	UP <div style="text-align: center;"> Select Menu <div style="border: 1px solid black; padding: 5px; display: inline-block;">Measure Interval 4000 ms</div> ENT </div>	Numerical Entry Change Value: UP Next Digit: DN Select New Value: ENT Exit Measure Interval Selection: ESC
	UP <div style="text-align: center;"> Select Menu <div style="border: 1px solid black; padding: 5px; display: inline-block;">Calibration-Fact 1508 Pulse/Gal</div> ENT </div>	Numerical Entry Change Value: UP Next Digit: DN Select New Value: ENT Exit Calibration Factor Selection: ESC
	UP <div style="text-align: center;"> Select Menu <div style="border: 1px solid black; padding: 5px; display: inline-block;">Measure Mode Pulse Width</div> ENT </div>	Tabular Entry Change Function: UP Select Function: DN Select New Value: ENT Exit Measure Mode Selection: ESC
	UP <div style="text-align: center;"> Select Menu <div style="border: 1px solid black; padding: 5px; display: inline-block;">NRF Damping Time 05 Second</div> ENT </div>	Numerical Entry Change Value: UP Next Digit: DN Select New Value: ENT Exit NRF Damping Time Selection: ESC
	UP <div style="text-align: center;"> Select Menu <div style="border: 1px solid black; padding: 5px; display: inline-block;">NRF Sample Numb 05</div> ENT </div>	Numerical Entry Change Value: UP Next Digit: DN Select New Value: ENT Exit NRF Sample Number Selection: ESC
	UP <div style="text-align: center;"> Select Menu <div style="border: 1px solid black; padding: 5px; display: inline-block;">Flow Linearizer Enabled</div> ENT </div>	Tabular Entry Change Function: UP Select Function: DN Select New Value: ENT Exit Flow Linearizer Selection: ESC
	UP <div style="text-align: center;"> Select Menu <div style="border: 1px solid black; padding: 5px; display: inline-block;">Fluid Density 1.12500 g/cm3</div> ENT </div>	Numerical Entry Change Value: UP Next Digit: DN Select New Value: ENT Exit Fluid Density Selection: ESC

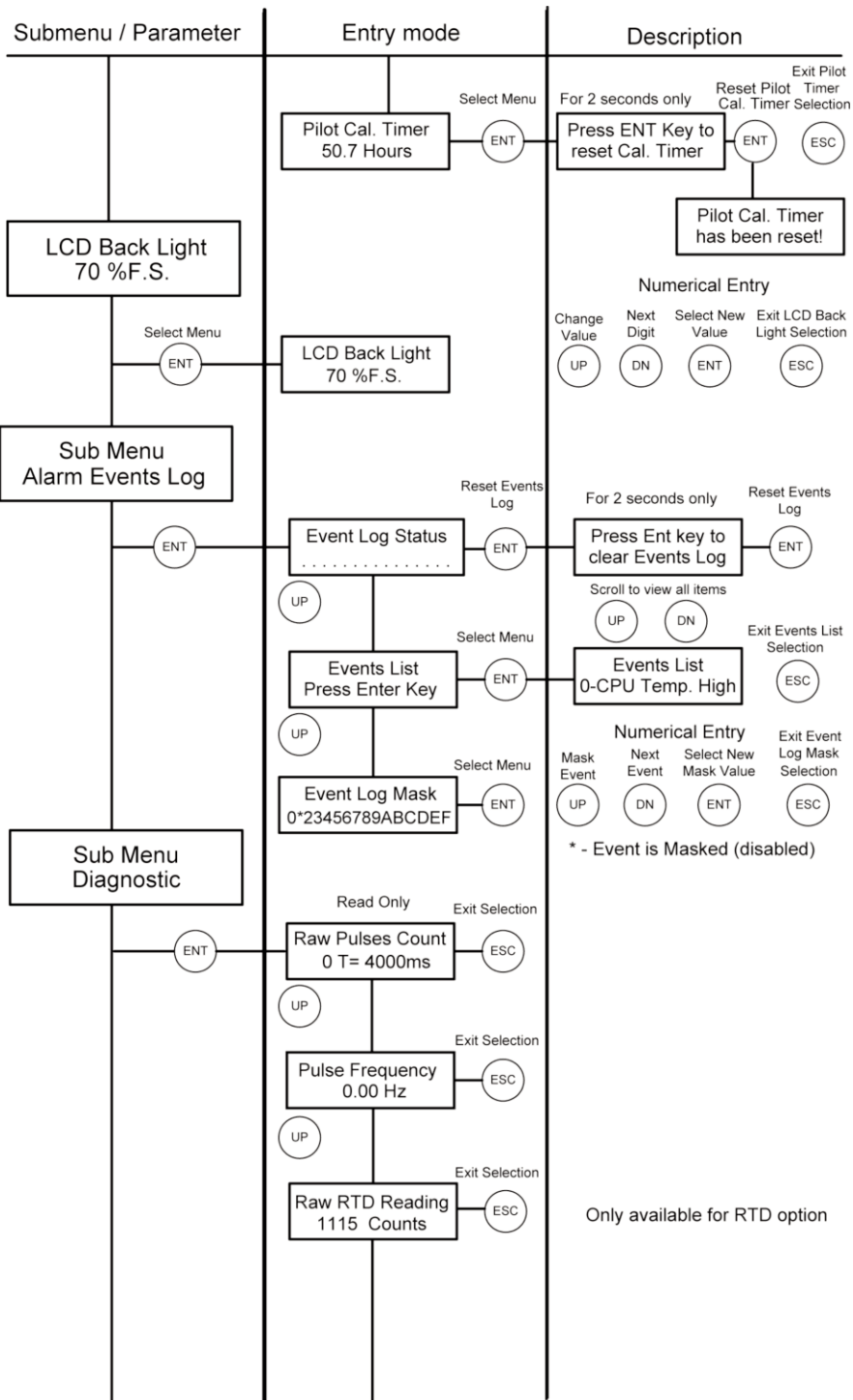

Submenu / Parameter

Entry mode

Description

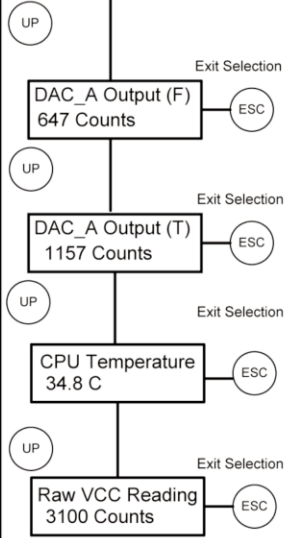

Only available for RTD option

4. PARAMETER ENTRY

There are two methods of data entry:

- Direct numerical number entry
- Tabular Input from a table menu.

If menu with direct numerical entry is selected use Up button to increment digit value from 0-9. Use Dn button to move cursor to another digit position. When desired value is entered use ENT button to accept (save in the EEPROM) new value.

If menu with tabular entry is selected, the available menu options can be set with the Up and Dn buttons and are accepted by pressing ENT button.



Note: During data entry the input values are checked for acceptability. If data is not acceptable, it is rejected and a message is generated indicating that the new data has not been accepted.

4.1 Submenu Program protection

After power has been turned on, programming parameters may only be changed by turning program protection "OFF". There are two ways to turn off the program protection:

1. If program protection code (PP-code) is on "0" (factory default), the program protection is turned off by pressing ENTER key.
2. If a PP-code (1 to 255) other than "0" has been entered, this code must be entered in order to turn the program protection "OFF".

The PP-code can be changed after the program protection has been turned off.

Prog. Protection code -----

In order to protect device configuration parameters when changing the PP-code the old PP-code must be entered after ENTER has been pressed.

Old PP-code? ----- 0

Press ENTER key after entry of old PP-code.

New PP-code ----- 0

Now enter the new PP-code (0-255) and press ENTER key. The new PP-code is now valid to turn off the program protection. If the PP-code is forgotten, it can be restored only via digital communication interface.

4.2 Submenu Flow Meter Info

This submenu contains information about the meter main configuration parameters. These items are informational only and may not be changed (read only).

4.2.1 Full Scale Flow

This display indicates the full scale range of the meter in L/min. The full scale range of the flow meter is related to the lower block inside diameter. It is set on the factory during calibration procedure. The full scale range of the meter is not user changeable. A typical display is shown below.

Full Scale Flow: 18.92706 L/min

4.2.2 Communication Interface

This display indicates type of the digital communication interface (RS232 or RS485) and device address (two hexadecimal characters of the address will be displayed only for RS485 interface option). All flow meters are shipped from the factory with default address 11. A typical display for device with RS485 option is shown below.

Comm. Interface: RS-485 ADD: 11

4.2.3 RTD hardware option

This display indicates presence of the RTD hardware. If second line of the screen indicates “Installed”, then flow meter is equipped with RTD with signal processing circuitry and ready for temperature measurement. A typical display for device with RTD option is shown below.

RTD Option:
Installed

4.2.4 Analog Flow Output settings

This display indicates which type of the jumper selectable Flow analog output is currently active. The device can be set for 0-5 Vdc or 4-20 mA output. A typical display for device with jumper configuration for 0-5 Vdc Flow output is shown below.

Analog Flow Out:
0-5 Vdc

4.2.5 Analog Temperature Output settings

This display indicates which type of the jumper selectable Temperature analog output is currently active. The device can be set for 0-5 Vdc or 4-20 mA output. A typical display for device with jumper configuration for 0-5 Vdc Temperature output is shown below.

Analog Temp Out:
0-5 Vdc



Note: Analog Temperature Output settings screen will be available on the devices which are not equipped with RTD option as well. In this case user should not be under impression that unit supports temperature measurement.

4.2.6 Flow Meter EEPROM data base version

This display indicates current version of the EEPROM data base. The EEPROM stores all flow meter configuration parameters. The Flow Meter EEPROM data base version is not user changeable. A typical display with EEPROM version is shown below.

EEPROM Version:
A001

4.2.7 Flow Meter Firmware version

This display indicates current version of the flow meter firmware. The Flow Meter Firmware version is not user changeable. A typical display with firmware version is shown below.

Firmware Version
A002

4.2.8 Flow Meter Serial number

This display indicates the serial number of the flow meter. This number is generated by the factory and is unique to the instrument. The flow meter serial number is not user-changeable. A typical display with flow meter serial number is shown below.

Serial Number:
245893-1

4.2.9 Flow Meter Model number

This display indicates the model number of the flow meter. The flow meter model number is not user-changeable. A typical display with flow meter model number is shown below.

Model Number:
FP1402-RTD

4.2.10 Fluid Name

This display indicates the name of the fluid the flow meter was calibrated for. The fluid name may be changed by user via digital communication interface. A typical display with fluid name is shown below.

Fluid Name:
WATER

4.2.11 Flow Meter Calibration Date

This display indicates the date when most recent calibration of the flow meter was performed. The calibration date may be changed by user via digital communication interface. A typical display with flow meter calibration date is shown below.

Calibration Date:

4.2.12 Flow Meter Calibration Date Due

This display indicates the date when next calibration of the flow meter has to be performed. The calibration date due may be changed by user via digital communication interface. A typical display with flow meter calibration date due is shown below.

Calib. Date Due:



Note: The Flow Meter Calibration Date Due parameter is provided solely for identification and maintenance purposes. Based on the application requirements, the user must decide, and enter here the next Calibration Date Due. Annual calibration, based on the installation date, is recommended.

4.2.13 Flow Meter User Tag Name

Flow meter Tag is the quickest and shortest way of identifying and distinguishing between multiple flow meters. Flow meters can be tagged according to the requirements of your application. The tag may be up to 16 characters long and is user-defined. A typical display with flow meter Tag Name is shown below.

User Tag Name:
NOT ASSIGNED

4.3 Submenu Measuring Units

This submenu allows selection of units for flow rate and Totalizer reading. Units should be selected to meet your particular metering needs.



Note: Once Flow Unit of Measure is changed the Totalizer's Volume based Unit of Measure will be changed automatically.

UNITS OF MEASURE				
NUMBER	INDEX	FLOW RATE ENGINEERING UNITS	TOTALIZER ENGINEERING UNITS	DESCRIPTION
1	0	%	%s	Percent of full scale
2	1	mL/sec	mL	Milliliter per second
3	2	mL/min	mL	Milliliter per minute
4	3	mL/hr	mL	Milliliter per hour
5	4	L/sec	Ltr	Liter per second
6	5	L/ min	Ltr	Liter per minute
7	6	L/hr	Ltr	Liter per hour
8	7	m ³ /sec	m ³	Cubic meter per second
9	8	m ³ / min	m ³	Cubic meter per minute
10	9	m ³ /hr	m ³	Cubic meter per hour
11	10	ft ³ /sec	ft ³	Cubic feet per second
12	11	ft ³ /min	ft ³	Cubic feet per minute
13	12	ft ³ /hr	ft ³	Cubic feet per hour
14	13	GI/sec	Gal	Gal per sec
15	14	GI/min	Gal	Gal per minute
16	15	Gal/hr	Gal	Gal per hour
17	16	g/sec	g	Grams per second
18	17	g/min	g	Grams per minute
19	18	g/hr	g	Grams per hour
20	19	kg/sec	kg	Kilograms per second
21	20	kg/min	kg	Kilograms per minute
22	21	kg/hr	kg	Kilograms per hour
23	22	Lb/sec	Lb	Pounds per second
24	23	Lb/min	Lb	Pounds per minute
25	24	Lb/hr	Lb	Pounds per hour
26	25	t/sec	Ton	Ton (metric) per sec
27	26	t/min	Ton	Ton (metric) per minute
28	27	t/hr	Ton	Ton (metric) per hour
29	28	User	UD	User defined

The listed units in the table above can be set with the Up and Dn buttons and are accepted by pressing ENT button.

4.3.1 User Defined Measuring Unit

This function enables user defined configuration of any engineering unit in the converter. The following three parameters are available for this function:

- a) Unit volume factor (defined in Liters)
- b) Unit time base (defined in Seconds)
- c) Unit with or without density support.



Note: The entry of the listed parameters a), b) and c) is only necessary in case the required engineering unit is not available in the table above, (see Section 4.3).

4.3.1.a User Defined Unit Factor Numeric entry

This parameter indicates the factor of the new unit with respect to one liter. The default entry is 1.00 Liter.

UD Unit Factor 1.00 Liter

4.3.1.b User Defined Unit Time Base Tabular entry

This parameter indicates the time base for User Defined Unit. The following selections are available: 1 second, 60 seconds (1 minute), 3600 seconds (1 Hour). The default entry is 60 seconds.

UDU Time Base 60 Seconds

The listed time based selections above can be set with the Up and Dn buttons and are accepted by pressing ENT button.

4.3.1.c User Defined Unit Density support Tabular entry

This function determines whether the newly entered user defined engineering unit is a mass unit (with density) or a volumetric unit (without density). The following selections are available: Enabled or Disabled. The default entry is Disabled.

UDU Use Density Disabled

The listed above density support selections can be set with the Up and Dn buttons and are accepted by pressing ENT button. If density was selected, also refer to section 4.9.8.

4.4 Submenu Flow Alarm

FP1400 provides the user with a flexible alarm/warning system that monitors the Fluid Flow for conditions that fall outside configurable limits as well as visual feedback for the user via the LCD (only for devices with LCD option) or via an optically isolated outputs.

The flow alarm has several attributes which may be configured by the user via optional LCD/Keypad or digital communication interface. These attributes control the conditions which cause the alarm to occur and to specify actions to be taken when the flow rate is outside the specified conditions.

Flow Alarm conditions become true when the current flow reading is equal or higher/lower than corresponding values of high and low flow alarm levels. Alarm action can be assigned with preset delay interval (0-3600seconds) to activate the optically isolated output (separate for High and Low alarm). Latch Mode control feature allows each optical output to be latched on or follow the corresponding alarm status.

4.4.1 Flow Alarm Mode Tabular entry

This function determines whether Flow Alarm is Enabled or Disabled. The following selections are available: Enabled or Disabled. The default entry is Disabled.

Flow Alarm Mode Disabled

The listed above Alarm Mode selections can be set with the Up and Dn buttons and are accepted by pressing ENT button.

4.4.2 Low Flow Alarm Numerical entry

The limit of required Low Flow Alarm value can be entered in increments of 0.1% from 0 - 100%F.S.



Note: The value of the Low Flow Alarm must be less than the value of the High Flow Alarm.

A typical display with flow meter Low Flow Alarm is shown below.

Low Flow Alarm
10.0 %F.S.

If a Low Alarm occurs, and one of the two optical outputs is assigned to the Low Alarm Event (see Section 4.8) the optically isolated output will be activated when the flow is less than the Low Flow Alarm value. The Flow Alarm condition is also indicated on the display Process Information Screen by displaying L character. A typical display with flow meter Process Information Screen and activated Low Flow Alarm is shown below.

0.401 Gl/min AL
MT: 65.81 Gal

4.4.3 High Flow Alarm Numerical entry

The limit of required High Flow Alarm value can be entered in increments of 0.1% from 0 - 100%F.S.



Note: The value of the High Flow Alarm must be more than the value of the Low Flow Alarm.

A typical display with flow meter High Flow Alarm settings is shown below.

High Flow Alarm
90.0 %F.S.

If a High Alarm occurs, and one of the two optical outputs is assigned to the High Alarm Event (see Section 4.8) the optically isolated output will be activated when the flow is more than the High Flow Alarm value. The Flow Alarm condition is also indicated on the display Process Information Screen by displaying H character. A typical display with flow meter Process Information Screen and activated High Flow Alarm settings is shown below.

4.641 GI/min AH
MT: 67.81 Gal

4.4.4 Flow Alarm Action Delay Numerical entry

The Flow Alarm Action Delay is a time in seconds that the Flow rate value must remain above the high limit or below the low limit before an alarm condition is indicated. Valid settings are in the range of 0 to 3600 seconds. A typical display with flow meter Flow Alarm Delay settings is shown below.

Flow Alarm Delay
1 Second

4.4.5 Flow Alarm Action Latch Tabular entry

The Flow Alarm Action Latch settings controls Latch feature when optically isolated outputs are assigned to Flow Alarm event. Following settings are available: Disable or Enabled.

By default, flow alarm is non-latching. That means the alarm is indicated only while the monitored flow value exceeds the specified set conditions. If optically isolated output is assigned to the Flow Alarm event, in some cases, the Flow Alarm Latch feature may be desirable.

Flow Alarm Latch
Disabled

The listed above Flow Alarm Action Latch selections can be set with the Up and Dn buttons and are accepted by pressing ENT button.

4.5 Submenu Temperature Alarm (*optional)

FP1400 with RTD option provides the user with a flexible alarm/warning system that monitors the Fluid Temperature for conditions that fall outside configurable limits as well as visual feedback for the user via the LCD (only for devices with LCD option) or via an optically isolated outputs.

The temperature alarm has several attributes which may be configured by the user via optional LCD/Keypad or digital communication interface. These attributes control the conditions which cause the alarm to occur and to specify actions to be taken when the temperature value is outside the specified conditions. Temperature Alarm conditions become true when the current temperature reading is equal or higher/lower than corresponding values of high and low temperature alarm levels. Alarm action can be assigned with preset delay interval (0-3600seconds) to activate the optically isolated output (separate for High and Low alarm). Latch Mode control feature allows each optical output to be latched on or follow the corresponding alarm status.

4.5.1 Temperature Alarm Mode Tabular entry

This function determines whether Temperature Alarm is Enabled or Disabled. The following selections are available: Enabled or Disabled. The default entry is Disabled.

Temp Alarm Mode
Disabled

The listed above Temperature Alarm Mode selections can be set with the Up and Dn buttons and are accepted by pressing ENT button.

4.5.2 Low Temperature Alarm Numerical entry

The limit of required Low Temperature Alarm value can be entered in increments of 0.1 °C from -9.9 °C to 99.9 °C.

A typical display with flow meter Low Temperature Alarm is shown below.



Note: The value of the Low Temperature Alarm must be less than the value of the High Temperature Alarm. The value of the Temperature can be entered only in °C units.

A typical display with flow meter Low Temperature Alarm is shown below.

Low Temp Alarm
0.0 C

If a Low Temperature Alarm occurs, and one of the two optical outputs is assigned to the Low Alarm Event (see Section 4.8) the optically isolated output will be activated when the temperature is less than the Low Temperature Alarm value.

The Temperature Alarm condition is also indicated on the display Process Information Screen by displaying L character. A typical display with flow meter Process Information Screen and activated Low Temperature Alarm is shown below.

5.001 Gl/min AD
-0.5 C TA: L

4.5.3 High Temperature Alarm Numerical entry

The limit of required High Temperature Alarm value can be entered in increments of 0.1°C from -9.9 °C to 99.9 °C.



Note: The value of the High Temperature Alarm must be more than the value of the Low Temperature Alarm.

A typical display with flow meter High Temperature Alarm settings is shown below



Note: The value of the Low Temperature Alarm must be less than the value of the High Temperature Alarm. The value of the Temperature can be entered only in °C units.

High Temp Alarm
50.0 C

If a High Temperature Alarm occurs, and one of the two optical outputs is assigned to the High Alarm Event (see Section 4.8) the optically isolated output will be activated when the flow is more than the High Temperature Alarm value.

The Temperature Alarm condition is also indicated on the display Process Information Screen by displaying H character. A typical display with flow meter Process Information Screen and activated High Temperature Alarm settings is shown below.

5.001 Gl/min AD
51.4 C TA: H

4.5.4 Temperature Alarm Action Delay Numerical entry

The Temperature Alarm Action Delay is a time in seconds that the Temperature value must remain above the high limit or below the low limit before an alarm condition is indicated. Valid settings are in the range of 0 to 3600 seconds. A typical display with flow meter Temperature Alarm Delay settings is shown below.

Temp Alarm Delay
1 Second

4.5.5 Temperature Alarm Action Latch Tabular entry

The Temperature Alarm Action Latch settings controls Latch feature when optically isolated outputs are assigned to Temperature Alarm event. Following settings are available: Disable or Enabled.

By default, flow alarm is non-latching. That means the alarm is indicated only while the monitored Temperature value exceeds the specified set conditions. If optically isolated output is assigned to the Temperature Alarm event, in some cases, the Temperature Alarm Latch feature may be desirable.

Temp Alarm Latch
Disabled

The listed above Temperature Alarm Action Latch selections can be set with the Up and Dn buttons and are accepted by pressing ENT button.

4.6 Submenu Main Totalizer

The total volume of the liquid is calculated by integrating the actual liquid flow rate with respect to time. The Main Totalizer value is stored in the EEPROM and saved every 1 second. In case of power interruption the last saved Totalizer value will be loaded on the next power on cycle, so Main Totalizer reading will not be lost. The optional LCD/keypad and digital communication interface commands are provided to:

- reset the totalizer to ZERO
- start the totalizer at a preset flow rate
- assign action at a preset total volume
- start/stop totalizing the flow



Note: Before enabling the Main Totalizer, ensure that all totalizer settings are configured properly. Totalizer Start values have to be entered in %F.S. engineering unit. The Totalizer will not totalize until the flow rate becomes equal to or more than the Totalizer Start value. Totalizer Stop values must be entered in currently active volume / mass based engineering units. If the Totalizer Stop at preset total volume feature is not required, then set Totalizer Stop value to zero (default settings).

4.6.1 Main Totalizer Mode Tabular entry

This function determines whether Main Totalizer is Enabled or Disabled. The following selections are available: Enabled or Disabled. The default entry is Disabled.

Main Total Mode
Disabled

The listed above Main totalizer Mode selections can be set with the Up and Dn buttons and are accepted by pressing ENT button.

4.6.2 Main Totalizer Flow Start Numerical entry

The Main Totalizer Start Flow value can be entered in increments of 0.1% from 0.0 – 100.0%F.S. A typical display with flow meter Main totalizer Start Flow settings is shown below.

MT Flow Start
5.0 %F.S.

4.6.3 Main Totalizer Event Volume Numerical entry

Main Totalizer Event Volume value must be entered in currently active volume / mass based engineering units. Totalizer action event become true when the totalizer reading and preset "Event Volume" values are equal.

If the Totalizer Event at preset total volume feature is not required, then set Totalizer Event Volume value to zero (default settings).

A typical display with flow meter Main Totalizer Event Volume settings is shown below.

MT Event Volume
0.0 Gal

4.6.4 Main Totalizer Reset Tabular entry

The Main Totalizers reading can be reset by pressing ENTER button. A typical display with flow meter Main Totalizer Reset screen is shown below.

Reset Main Total
Value?

The next conformation screen will appear only for 2 seconds.

Press Ent key to
reset Totalizer!

If during these two seconds user will press ENTER button again, the Main Totalizer volume will be reset to zero. Following screen will appear for two seconds.

The Totalizer has
been reset!

4.7 Submenu Pilot Totalizer

The total volume of the liquid is calculated by integrating the actual liquid flow rate with respect to time. The Pilot Totalizer value is stored in the flow meter volatile memory (SRAM) and saved every 100 ms. In case of power interruption the Pilot Totalizer volume will be lost (reset to zero). The optional LCD/keypad and digital communication interface commands are provided to:

- reset the totalizer to ZERO
- start the totalizer at a preset flow rate
- assign action at a preset total volume
- start/stop totalizing the flow



Note: Before enabling the Pilot Totalizer, ensure that all totalizer settings are configured properly. Totalizer Start values have to be entered in %F.S. engineering unit. The Totalizer will not totalize until the flow rate becomes equal to or more than the Totalizer Start value. Totalizer Stop values must be entered in currently active volume / mass based engineering units. If the Totalizer Stop at preset total volume feature is not required, then set Totalizer Stop value to zero (default settings).

4.7.1 Pilot Totalizer Mode Tabular entry

This function determines whether Pilot Totalizer is Enabled or Disabled. The following selections are available: Enabled or Disabled. The default entry is Disabled.

Pilot Total Mode
Disabled

The listed above Pilot totalizer Mode selections can be set with the Up and Dn buttons and are accepted by pressing ENT button.

4.7.2 Pilot Totalizer Flow Start Numerical entry

The Pilot Totalizer Start Flow value can be entered in increments of 0.1% from 0.0 – 100.0%F.S. A typical display with flow meter Pilot totalizer Start Flow settings is shown below.

PT Flow Start
10.0 %F.S.

4.7.3 Pilot Totalizer Event Volume Numerical entry

Pilot Totalizer Event Volume value must be entered in currently active volume / mass based engineering units. Totalizer action event become true when the totalizer reading and preset "Event Volume" values are equal.

If the Totalizer Event at preset total volume feature is not required, then set Totalizer Event Volume value to zero (default settings). A typical display with flow meter Pilot Totalizer Event Volume settings is shown below.

PT Event Volume
0.0 Gal

4.7.4 Pilot Totalizer Reset Tabular entry

The Pilot Totalizers reading can be reset by pressing ENTER button. A typical display with flow meter Pilot Totalizer Reset screen is shown below.

Reset Pilot Total
Value?

The next conformation screen will appear only for 2 seconds.

Press Ent key to
reset Totalizer!

If during these two seconds user will press ENTER button again, the Pilot Totalizer volume will be reset to zero. Following screen will appear for two seconds.

The Totalizer has
been reset!

4.8 Submenu Optical Outputs Numerical entry

Two sets of optically isolated outputs are provided to actuate user supplied equipment. These are programmable via digital interface or optional LCD/Keypad such that the outputs can be made to switch when a specified event occurs (e.g. when a low or high flow alarm limit is exceeded or when the totalizer reaches a specified value) or may be directly controlled by user.

The user can configure each optical output action from 11 different options:

- Disabled: No Action (output is not assigned to any events and not energized)
- Low Flow Alarm
- High Flow Alarm
- Range between H&L Flow alarm settings
- Main Totalizer reading exceed set limit
- Pilot Totalizer reading exceed set limit
- Low Temperature alarm (*RTD option only)
- High Temperature alarm (*RTD option only)
- Range between High and Low Temperature alarm (*RTD option only)
- Diagnostic: Output will be energized when any of the Diagnostic events are active
- Manual On Control: Output will be energized until Disabled option will be selected.

A typical display with Optical Output Function selection is shown below.

Opt #1 function
Disabled

The listed above Optical Output selections can be set with the Up and Dn buttons and are accepted by pressing ENT button.

4.9 Submenu Flow Meter Configuration

4.9.1 Submenu Flow Meter Low Flow Cut-off Numerical entry

The low flow cut-off can be selected between 0.0 and 10.0 % of the full scale range. Flows less than the cut-off value are internally driven to zero and not totalized. The analog 0-5 vdc or 4-20mA current outputs are set to 0.0 Vdc and 4.00 mA correspondently. The switching threshold for the low flow cut-off has 1.0 %F.S. hysteresis. A typical display with Low Flow Cut-off selection is shown below.

Low Flow Cut-off
1.000 %F.S.

4.9.2 Submenu Pulse Number Measure Interval Numerical entry

Signal Processing software algorithm can be set to calculate flow rate based on two different methods (see Section 4.9.4):

- a) number of pulses over preset measure interval
- b) pulse width measurement

Both methods calculates frequency of the pulses from the flow meter sensor. The number of pulses over preset measure interval method convenient when pulsating flow or especially noisy signals are encountered.

This method allows to get stable average flow rate if pulse measure interval is set to values more than 4000 ms. This parameters effects the flow update rate. With higher value of the pulse measure interval, the resolution and stability of the flow measurement improves, but response time become longer. A suggested pulse measure interval value of 4000 seconds is a good starting point for most applicable process fluids. With lower settings the response time of the meter will be shorter, but resolution and stability will degrade.

The pulse measure interval settings are only related to the number of pulses over preset measure interval method. Pulse measure interval can be selected between 500 and 60000 ms. A typical display with pulse measure interval selection is shown below.

Measure Interval
4000 ms

4.9.3 Submenu Flow Meter Calibration Factor Numerical entry

Calibration Factor is defined as the number of pulses from flow sensor per one gallon of fluid passing through the meter. This is the parameter by which the factory calibrates the flow meter. Change of this parameter is rarely needed by customers. It is only necessary if you believe the FP1400 flow meter is no longer accurate.



Note: Your FP1400 Flow Meter was calibrated at the factory for the specified fluid and full scale flow range (see device's label or calibration data sheet). There is no need to adjust the Flow Meter calibration factor, unless adjustment for specific installation or fluid is needed. Any alteration of the flow meter calibration factor will VOID calibration warranty supplied with instrument.

A typical display with Calibration Factor selection is shown below.

Calibration-Fact
1366 Pulse/Gal

4.9.4 Submenu Flow Meter Measure Mode Tabular entry

Signal Processing software algorithm can be set to calculate flow rate based on two different methods:

- a) number of pulses over preset measure interval
- b) pulse width measurement

First method (a) was explained earlier (see Section 4.9.2). Second method (b) allows get quick response time and best resolution of the flow rate, but with pulsating or especially noisy flow environment the stability of the flow rate reading may be compromised. A digital filter (noise reduction algorithm) is available in the flow meter when pulsating flow or especially noisy signals are encountered (see Sections 4.9.5 and 4.9.6). The digital filter improves the displayed instantaneous flow values.

The digital filter only works with pulse width measurement method and is not applicable for flow measurement mode (a) – “number of pulses over measure interval”. A typical display with Measure Mode selection is shown below. By default unit shipped from the factory with Measure Mode set to “Pulse Width”.

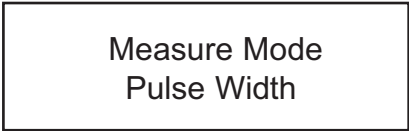

4.9.5 Submenu Noise Reduction Filter Damping Time Numerical entry

A noise reduction filter algorithm (running average of the individual flow inputs) is available in the flow meter when pulsating flow or especially noisy signals are encountered. There are two parameters that make up **Signal Processing Control**: Damping Time and Number of Samples. They are described individually below.

Damping Time: The damping value can be selected between 0 and 99 seconds. The value represents the response time of the running average flow rate change. The higher the damping value the longer the response time of the filter. If noise reduction filter is not desired it may be disabled by setting Damping Time parameter to zero. By default unit shipped from the factory with Damping Time value set to 5. A typical display with Damping Time selection is shown below.



4.9.6 Submenu Noise Reduction Filter Sample Number Numerical entry

This is the second parameter that makes up noise reduction filter algorithm. The sample number value can be selected between 1 and 32. The number of samples value represents the number of previous individual inputs used to calculate the average value. Eventually the number of samples in the running average also affects the response time. The more samples is used, the more inertial flow output reading will be to the actual flow change. A suggested nominal number of 5 samples is a good starting point for most applicable process fluids. A typical display with Sample Number selection is shown below.

NRF Sample Numb.
05

4.9.7 Submenu Flow Linearizer Tabular entry

The Flow Linearization algorithm may be used to improve linearity of the flow measurement. The Flow Linearization table is built during factory calibration procedure and stored in the device EEPROM. The Flow Linearizer can be used with both flow measurement algorithms. By default unit shipped from the factory with enabled Flow Linearizer. A typical display with Flow Linearizer selection is shown below.

Flow Linearizer
Enabled

The listed above Flow Linearizer selections can be set with the Up and Dn buttons and are accepted by pressing ENT button.

4.9.8 Submenu Fluid Density Numerical entry

When the flow is displayed in gravimetric (mass based) units (e.g: g, kg, t, pound) a density value of the actual fluid must be entered for the flow rate and total calculation. The translation conversion to mass flow is settable between 0.01 and 5.00000 g/cm³. A typical display with Fluid Density selection is shown below.

Fluid Density
1.12500 g/cm³

4.9.9 Submenu Pilot Calibration timer Tabular entry

The Pilot Calibration timer accumulates operational hours since last time unit was calibrated. The value of the timer may be reset by the user by pressing Ent button. A typical display with Calibration timer selection is shown below.

Pilot Cal. Timer
70.0 Hours

Once Ent button is pressed the next conformation screen will appear only for 2 seconds.

Press Ent key to
reset Cal. Timer

If during these two seconds user will press ENTER button again, the Calibration Timer value will be reset to zero.

4.10 Submenu LCD Back Light Numerical Entry

This parameter indicates the level (intensity) of the LCD back light. The value of the LCD back light level can be entered in increments of 1% from 0 - 80%F.S. If LCD back light is not desired, it can be turn off by setting back light level to zero. A typical display with LCD Back Light selection is shown below.

LCD Back Light
50 %F.S.

4.11 Submenu Alarm Events Log

FP1400 series Flow Meters are equipped with a self-diagnostic alarm event log which is available via digital interface and on screen LCD indication (for devices with optional LCD). A typical display with Alarm Events Log selection is shown below.

Sub Menu
Alarm Events Log

The following diagnostic events are supported:

Event Number	Diagnostic Alarm Event Description	LCD bit Code
1	CPU Temperature too High	0
2	Flow rate more than 125% F.S.	1
3	High Flow Alarm	2
4	Low Flow Alarm	3
5	High Fluid Temperature Alarm	4
6	Low Fluid Temperature Alarm	5
7	Fluid Temperature Above measurement Limit	6
8	Fluid Temperature Below measurement Limit	7
9	Main Totalizer exceed set event volume limit	8
10	Pilot Totalizer exceed set event volume limit	9
11	EEPROM Failure	10
12	DC/DC converter Voltage too High	11
13	DC/DC converter Voltage too Low	12
14	Communication Error	13
15	Reserved	14
16	FATAL ERROR (reset or maintenance service is required for return in to the normal operation)	15



Any Alarm events that may have occurred (Event 0 to Event F) are stored in the internal register. All detected events remain stored until the register is manually reset (by pressing ENTER key or by means of the digital communication interface). The Alarm Event Log register is mapped to the SRAM (volatile memory). In case of power interruption the Alarm Event Log register will be automatically reset.

4.11.1 Submenu Alarm Events Log Status

Each alarm event has fixed designated position on the LCD screen. Most significant event code (F) is set on the right side of the LCD and least significant event code (0) is set on the left side of the LCD. If event is not present (not active) it is represented on the LCD as dot (.) character. If event is present (or was detected in the past) it is represented on the LCD with corresponding character. A typical display with Alarm Events Log Status without any detected events is shown below.

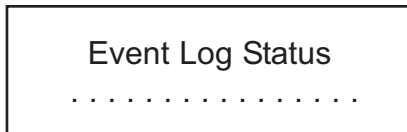

In the example shown below, event 1 (Flow rate more than 125% F.S.) and event 2 (High Flow Alarm) have occurred since the last reset.



Note: Each Alarm Event can be individually masked (disabled) using Event Log Mask menu selection (see Section 4.11.3) If alarm event is masked (disabled) it will not be registered in the Event Status Log even actual event has occurred.

In order to reset (clear) Event Log press Ent button. Following screen will appear just for two seconds.

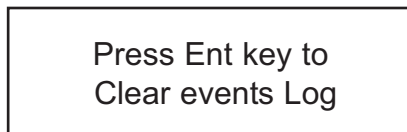

If during these two seconds user will press Ent button again, the Alarm Event Log will be cleared.

4.11.2 Submenu Alarm Events List

This menu selection provides list of the descriptions and corresponding code for all supported events.

Events List
Press Enter Key

If ENTER is pressed again, the description for each error is displayed:

Events List
0-CPU Temp. High

The shown above Event List selections can be scrolled with the Up and Dn buttons. By pressing ENT or Esc buttons user may exit from scrolling mode.

4.11.3 Submenu Alarm Events Log Mask

With this menu selection user may individually mask (disable) any Alarm Event. A typical display with Alarm Events Mask selection is shown below.

Event Log Mask
0*23456789ABCDEF

In the example shown above, event 1 (Flow rate more than 125% F.S.) is masked with asterisk. In order to change event mask settings user should press Ent button. The flashing cursor will appear on the left of the LCD screen (on the 0 event position). Use Dn button to move to desired event code. Use Up button to change mask status (asterisk represent masked event). Use Ent button to accept and save new mask settings.

4.12 Submenu Diagnostic

This submenu provides troubleshooting information about the meter internal variables. These items are informational only and may not be changed (read only).

4.12.1 Submenu Raw Pulses Count

This menu selection provides number of pulses from the flow sensor within specific measurement interval.

Raw Pulses Count
400 T= 4000mS

In the example shown above the raw pulses count is 400 within 4000 ms measuring interval, which represents pulse frequency of 100 Hz.

4.12.2 Submenu Pulse Frequency

This menu selection provides raw value of the frequency from the pulse width measurement circuitry.

Pulse Frequency
100.00 Hz

4.12.3 Submenu Raw RTD reading (RTD option only)

This menu selection provides raw value of the ADC counts for RTD circuitry. The reading only applicable for FP1400 meters with optional RTD functionality.

Raw RTD Reading
1250 Counts

4.12.4 Submenu DAC_A Flow Output

This menu selection provides current value of the DAC register for analog flow output circuitry.

DAC_A Output (F)
3125 Counts

4.12.5 Submenu DAC_B Temperature Output

This menu selection provides current value of the DAC register for analog temperature output circuitry.

DAC_B Output (T) 1358 Counts

4.12.6 Submenu CPU Temperature

This menu selection provides current value of the PCB and CPU temperature in °C.

CPU Temperature 35.8 C

4.12.7 Submenu Raw VCC Reading

This menu selection provides current normalized value of the DC/DC converter output in counts. The typical values are in the range between 2800 and 3200 counts.

Raw VCC Reading 3065 Counts

5. Analog Output Signals

5.1 Analog Output Signals configuration

FP1400 series Flow Meters are equipped with calibrated 0-5 Vdc and/or 4-20 mA output signals for flow and temperature* process variables. The set of the jumpers (J3A, J3B, J3C, J3D, J3E, J3F) located on the top of the flow meter, inside of the maintenance access window (see Figure 5-1 “FP1400 configuration jumpers”) are used to switch between 0-5 Vdc or 4-20 mA output signals. Jumpers J3A, J3B, J3C are used to set flow analog output type and jumpers J3D, J3E, J3F are used to set temperature* analog output type (see Table 5-1). Jumper J3G is used to configure RS485 termination resistor (by default is off).

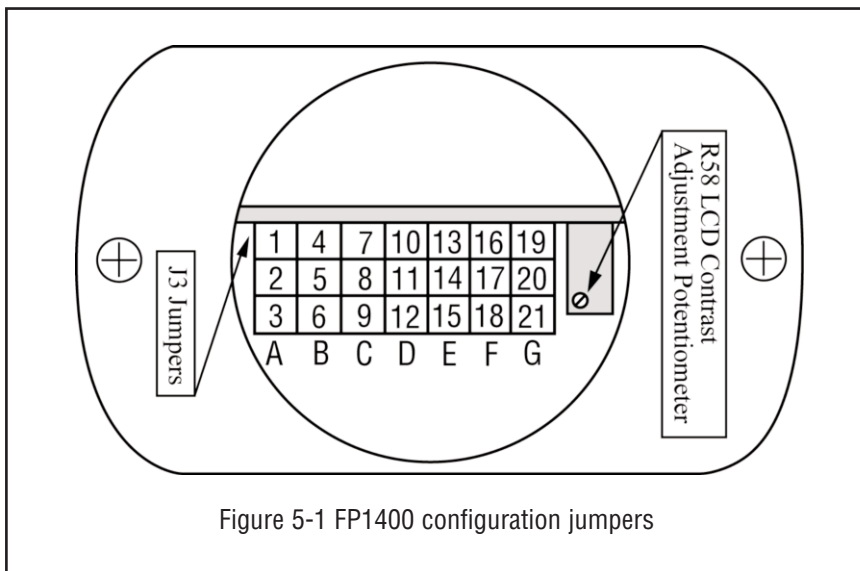

	Function	Analog Flow Output			Analog Temp. Output*			RS485
		J3A	J3B	J3C	J3D	J3E	J3F	J3G
Analog Output	0-5 Vdc	2-3	5-6	8-9	11-12	14-15	17-18	
	4-20 mA	1-2	4-5	7-8	10-11	13-14	16-17	
RS485 220 Ohm Termination Resistor	OFF							20-21
	ON							19-20

Table 5-1

5.2 Analog Output Signals calibration



Note: The analog output available on the FP1400 Flow Meter was calibrated at the factory for the specified fluid and full scale flow range (see the device's front label). There is no need to perform analog output calibration unless the EEPROM IC was replaced or offset/span adjustment is needed. Any alteration of the analog output scaling variables in the EEPROM table will VOID calibration warranty supplied with instrument.



Note: It is recommended to use the Omega® supplied calibration and maintenance software for analog output calibration. This software includes an automated calibration procedure which may radically simplify calculation of the offsets and spans variables and, the reading and writing for the EEPROM table.

The FP1400 analog output calibration involves calculation and storing of the offset and span variables in the EEPROM for each available output. The 0-5 Vdc output has only scale variable and 20 mA output has offset and scale variables. The following is a list of the EEPROM variables used for analog output computation:

Analog Flow Output variables

Index	Name	Description
39	FoutScaleV	- DAC 0-5 Vdc Flow Analog Output Scale
41	FoutScale_mA	- DAC 4-20mA Flow Analog Output Scale
42	FoutOffset_mA	- DAC 4-20mA Flow Analog Output Offset

Analog Temperature Output variables*

Index	Name	Description
43	ToutScaleV	- DAC 0-5 Vdc Temperature Analog Output Scale
45	ToutScale_mA	- DAC 4-20mA Temperature Analog Output Scale
46	ToutOffset_mA	- DAC 4-20mA Temperature Analog Output Offset

5.2.1 Initial Setup

Power up the FP1400 Flow Meter for at least 15 minutes prior to commencing the calibration procedure. Make sure absolutely no flow takes place through the meter. Establish digital RS485/RS232 communication between PC (communication terminal) and FP1400. The commands provided below assume that calibration will be performed manually (w/o Omega® supplied calibration and maintenance software) and the device has RS485 address 11. If Omega® supplied calibration and maintenance software is used, skip the next section and follow the software prompts.

Enter Backdoor mode by typing: !11,MW,1000,1[CR]

Unit will respond with: !11,BackDoorEnabled: Y

Disable DAC update by typing: !11,WRITE,4,Y[CR]

Unit will respond with: !11,DisableUpdate: Y

5.2.2 Flow 0-5 Vdc analog output calibration

1. Install jumpers J3A, J3B and J3C on the PC board for 0-5 Vdc output (see Table 5-1).
2. Connect a certified high sensitivity multi meter set for the voltage measurement to the pins M (+) and K (-) of the FP1400 12 Pin "M16" connector.
3. Write 4000 counts to the DAC_A channel: !11,WRITE,0,4000[CR]
4. Read voltage with the meter and calculate FOutScaleV value:

$$\text{FoutScaleV} = \frac{20000}{\text{Reading[V]}}$$

5. Save FOutScaleV in to the EEPROM: !11,MW,39,X[CR]

Where: X – the calculated FoutScaleV value.

5.2.3 Flow 4-20 mA analog output calibration

1. Install jumpers J3A, J3B and J3C on the PC board for 4-20 mA output (see Table 5-1).
2. Connect a certified high sensitivity multi meter set for the current measurement to pins M (+) and K (-) of the FP1400 12 Pin "M16" connector.
3. Write 4000 counts to the DAC_A channel: !11,WRITE,0,4000[CR]
4. Read current with the meter and calculate FoutScale_mA value:

$$\text{FoutScale_mA} = \frac{4000}{\text{Reading[mA]}}$$

5. Write zero counts to the DAC_A channel: !11,WRITE,0,0CR]
6. Read offset current with the meter and calculate FoutOffset_mA value:

$$\text{FoutOffset_mA} = -\text{FOutScale_mA} * \text{Offset_Reading[mA]}$$

7. Save FoutScale_mA in to the EEPROM: !11,MW,41,Y[CR]
Save FoutOffset_mA in to the EEPROM: !11,MW,42,Z[CR]

Where: Y – the calculated FoutScale_mA value.
Z – the calculated FoutOffset_mA value.

5.2.4 Temperature 0-5 Vdc analog output calibration*

1. Install jumpers J3D, J3E and J3F on the PC board for 0-5 Vdc output (see Table 5-1).
2. Connect a certified high sensitivity multi meter set for the voltage measurement to the pins L (+) and K (-) of the FP1400 12 Pin "M16" connector.
3. Write 4000 counts to the DAC_B channel: !11,WRITE,1,4000[CR]
4. Read voltage with the meter and calculate TOutScaleV value:

$$\text{ToutScaleV} = \frac{20000}{\text{Reading[V]}}$$

5. Save TOutScaleV in to the EEPROM: !11,MW,43,X[CR]

Where: X – the calculated ToutScaleV value.

5.2.5 Temperature 4-20 mA analog output calibration*

1. Install jumpers J3D, J3E and J3F on the PC board for 4-20 mA output (see Table 5-1).
2. Connect a certified high sensitivity multi meter set for the current measurement to pins L (+) and K (-) of the FP1400 12 Pin "M16" connector.
3. Write 4000 counts to the DAC_B channel: !11,WRITE,1,4000[CR]
4. Read current with the meter and calculate ToutScale_mA value:

$$\text{ToutScale_mA} = \frac{4000}{\text{Reading[mA]}}$$

5. Write zero counts to the DAC_B channel: !11,WRITE,1,0CR]
6. Read offset current with the meter and calculate ToutOffset_mA value:

$$\text{ToutOffset_mA} = -\text{TOutScale_mA} * \text{Offset_Reading[mA]}$$

7. Save ToutScale_mA in to the EEPROM: !11,MW,45,Y[CR]
Save ToutOffset_mA in to the EEPROM: !11,MW,46,Z[CR]

Where: Y – the calculated ToutScale_mA value.
 Z – the calculated ToutOffset_mA value.



Note: When done with the analog output calibration make sure the DAC update is enabled and the BackDoor is closed (see command below).

Enable DAC update by typing: !11,WRITE,4,N[CR]
Unit will respond with: !11,DisableUpdate: N
Close BackDoor access by typing: !11,MW,1000,0[CR]
Unit will respond with: !11,BackDoorEnabled: N

6. **FP1400 FLOW CALIBRATION PROCEDURES**



NOTE: REMOVAL OF THE FACTORY INSTALLED CALIBRATION SEALS AND/OR ANY ADJUSTMENTS MADE TO THE METER, AS DESCRIBED IN THIS SECTION, WILL VOID ANY CALIBRATION WARRANTY APPLICABLE.

Omega® Engineering' Flow Calibration Laboratory offers professional calibration support for FP1400 Flow Meters using precision calibrators under strictly controlled conditions. NIST traceable calibrations are available. Calibrations can also be performed at customers' site using available standards.



Note: All adjustments in this section are made from the outside of the meter via digital communication interface between a PC (terminal) and FP1400 or via local LCD/KeyPad. There is no need to disassemble any part of the instrument or perform internal PCB component (potentiometers) adjustment.

6.1 **Connections and Initial Warm Up**

Power up the FP1400 Flow Meter for at least 1minutes prior to commencing the calibration procedure. Establish digital RS485/RS232 communication between PC (communication terminal) and the FP1400. Start Omega® supplied calibration and maintenance software on the PC.

6.2 Flow Meter Span Calibration



Note: Your FP1400 Flow Meter was calibrated at the factory for the specified fluid and full scale flow range (see device's front label). There is no need to adjust the Calibration Factor or Flow linearization table unless linearity adjustment is needed, flow range has to be changed. Any alteration of the Calibration Factor or flow linearization table will VOID calibration warranty supplied with instrument.

Using Omega® supplied calibration and maintenance software start Set Span procedure by navigating to the Tools/Set Span/PulseCounts menu. The software will display screen with current frequency and calculated Calibration Factor. Using the installation flow regulator, adjust the flow rate to 100% of full scale flow. Check the flow rate indicated against the flow calibrator. Once required flow rate is established click Save button. The new Calibration Factor will be saved in to the EEPROM table (index 61) and device linearization table (EEPROM indexes 62-83) will be initialized with default linear values.



Note: Described above procedure will reinitialize entire Linearization table. If it is desirable to keep existing linearization table and only minor adjustment of the calibration curve is required it is recommended perform linearization table adjustment starting from 90% F.S. (see Section 6.3).

Calibration Factor also can be adjusted using local LCD/KeyPad interface (see Section 4.9.3).

6.3 Flow Meter Linearization Table Calibration

The FP1400 flow linearization table calibration involves building a table of the actual flow values (EEPROM indexes 62, 64, 66, 68, 70, 72, 74, 76, 78, 80, 82) and corresponding sensor readings (EEPROM indexes 63, 65, 67, 69, 71, 73, 75, 77, 79, 81, 83). Actual flow values are entered in normalized fraction format: 100.000 % F.S. corresponds to 1.000000 flow value and 0.000 % F.S. corresponds to 0.000000 flow value. The valid range for flow values is from 0.000000 to 1.000000 (note: FP1400 will accept up to 6 digits after decimal point). Sensor readings are entered in pulses and should always be in the range of 10 to 4000. There are 11 elements in the table so the data should be obtained at an increment of 10.0 % of full scale (0.0, 10.0, 20.0, 30.0, 40.0, 50.0, 60.0, 70.0, 80.0, 90.0 and 100.0 % F.S.).



Note: Do not alter memory index 62 (must be 0.0) and 63 (must be 0 counts). These numbers represent zero flow calibration points and should not be changed.

If a new calibration table is going to be created, it is recommended to start calibration from 100% full scale. If only linearity adjustment is required, calibration can be started in any intermediate portion of the gas table.

Using the flow regulator, adjust the flow rate to 100% of full scale flow. Check the flow rate indicated against the flow calibrator. Observe the flow reading on the FP1400. If the difference between calibrator and FP1400 flow reading is more than 0.5% F.S., make a correction in the sensor reading in the corresponding position of the linearization table (see Index 83).

If the flow FP1400 reading is more than the calibrator reading, the number of counts in the index 83 must be decreased. If the FP1400 flow reading is less than the calibrator reading, the number of counts in the index 83 must be increased. Once Index 83 is adjusted with a new value, check the FP1400 flow rate against the calibrator and, if required, perform additional adjustments for Index 83. If a simple communication terminal is used for communication with the FP1400, then “MW” (Memory Write) command from the software interface commands set may be used to adjust sensor value in the linearization table (see section 8.3 for complete software interface commands list). Memory Read “MR” command can be used to read the current value of the index.

Assuming the FP1400 is configured with RS485 interface and has address “11”, the following example will first read the existing value of Index 83 and then write a new adjusted value:

!11,MR,83[CR] - reads EEPROM address 83

!11,MW,83,1200[CR] - writes new sensor value (1200 counts) in to the index 83

Once 100% F.S. calibration is completed, the user can proceed with calibration for another 9 points of the linearization table by using the same approach.



Note: Once memory index 83 is changed the device firmware will automatically update Calibration Factor (EEPROM index 61).



Note: It is recommended to use Omega® supplied calibration and maintenance software for linearization table calibration. This software includes an automated calibration procedure which may radically simplify reading and writing for the EEPROM linearization table.

7. RS485/RS232 SOFTWARE INTERFACE COMMANDS

7.1 General

The standard FP1400 comes with an RS485 interface. For the optional RS232 interface, the start character (!) and two hexadecimal characters for the address must be omitted. The protocol described below allows for communications with the unit using either a custom software program or a “dumb terminal.” All values are sent as printable ASCII characters. For RS485 interface, the start character is always (!). The command string is terminated with a carriage return (line feeds are automatically stripped out by the FP1400). See Section 2.2.5 for information regarding communication parameters and cable connections.

7.2 Commands Structure

The structure of the command string:

!<Addr>,<Cmd>,Arg1,Arg2,Arg3,Arg4<CR>

Where:

!	Start character **
Addr	RS485 device address in the ASCII representation of hexadecimal (00 through FF are valid). **
Cmd	The one or two character command from the table below.
Arg1 to Arg4	The command arguments from the table below. Multiple arguments are comma delimited.
CR	Carriage Return character.

** - OMIT FOR RS232 INTERFACE.

Several examples of commands for RS485 option follow. All assume that the FP1400 meter has been configured for address 18 (12 hex) on the RS485 bus:

1. To get a flow reading: !12,F<CR>

The device will reply: !12,50.0<CR> (Assuming the flow is at 50.0% FS)

2. To get current Flow Alarm status: !12,FA,R<CR>

The device will reply: !12,FA,N<CR> > (Assuming no alarm conditions)

3. To get a Main Totalizer reading: !12,MT,R<CR>

The device will reply: !12,MT:93.05<CR>
(Assuming the Main totalizer reading is 93.5)

4. Set the flow high alarm limit to 85% of full scale flow rate:

!12,FA,H,85.0<CR>

The device will reply: !12,FA,H:85.0<CR>

Several examples of commands for RS232 option follow.

1. To get a flow reading: F<CR>

The device will reply: 50.0<CR> (Assuming the flow is at 50.0% FS)

2. To get current Flow Alarm status:FA,R<CR>

The device will reply: FA,N<CR> > (Assuming no alarm conditions)

3. To get a Main Totalizer reading: MT,R<CR>

The device will reply: MT:93.05<CR>

(Assuming the Main totalizer reading is 93.5)

4. Set the flow high alarm limit to 85% of full scale flow rate: FA,H,85.0<CR>

The device will reply: FA,H:85.0<CR>

7.3 ASCII Commands Set

OMEGA FP1400 METER ASCII SOFTWARE INTERFACE COMMANDS

NOTE: AN "*" INDICATES POWER UP DEFAULT SETTINGS.

AN "***" INDICATES OPTIONAL FEATURE NOT AVAILABLE ON ALL MODELS.

COMMAND NAME	DESCRIPTION	NO.	COMMAND SYNTAX						RESPONSE
			COMMAND	ARGUMENT 1	ARGUMENT 2	ARGUMENT 3	ARGUMENT 4		
Flow	Requests the current flow sensor reading in current EU	1	F						<Value> (Actual flow in current engineering units)
Temperature**	Requests the current temperature reading in current EU (°C or °F)	2	T						<Value> (Actual temp. in current engineering units)
Diagnostic Events	Read/Reset current status of Diagnostic Events Log register.	3	DE	NO ARGUMENT (read status)					DE:0x10 0x10 – diagnostic word (16 bits wide)
				R (reset Event Log register to 0x00)					DE:0x0
Diagnostic Mask	Display/Set Diagnostic Events Mask register See list of the Diagnostic Events below.	4	DM	NO ARGUMENT (read current Diagnostic Events Mask register)					DM:0x9FFF 0x9FFF – diagnostic mask (16 bits wide). Set bit - Enable Clear bit - Disable
				<Value> 0x0000 To 0xFFFF NOTE: all 6 characters are required					DM:0x9FFF

COMMAND SYNTAX								
COMMAND NAME	DESCRIPTION	NO.	COMMAND	ARGUMENT 1	ARGUMENT 2	ARGUMENT 3	ARGUMENT 4	RESPONSE
Meter Info	Requests meter configuration info: - full scale range (L/min) - RTD option support(Y,N) - Analog Flow Output configuration (V,C) - Analog Temp. Output configuration (V,C)	5	MI					MI: 18.92706,Y,V,V Y – RTD support N – No RTD support V – 0-5 Vdc output C – 4-20mA output
Flow Alarms	Sets / reads the status of the flow alarms. Note: High and Low limits have to be entered in the %F.S. High alarm value has to be more than Low alarm value. Alarm conditions: Flow > High Limit = H Flow < Low Limit = L Low < Flow < High = N	6	FA	H (high flow limit)	<Value>(0-100%FS)			FAH:<Value (%F.S.)>
				L (low flow limit)	<Value>(0-100%FS)			FAL:<Value (%F.S.)>
				A (action delay in seconds)	<Value> (0-3600 sec.)			FAA:<Value (sec)>
				E (enable alarm)				FAE
				D (disable alarm)*				FA:D
				R (read current status)				FA:R (no alarm) FA:H (high alarm) FA:L (low alarm)
				S (Read current settings)				FAS:M,L,H,D,B where: M – mode (E/D) L – Low settings (%FS) H – High settings (%FS) D – Action Delay (sec) B – Latch mode (0-3)
				B Block (Latch) mode	<Value> (0-disabled*) (1-enabled L) (2-enabled H) (3 –both L,H)			FAB:<Value> where: Value = 0 – 3

COMMAND SYNTAX								
COMMAND NAME	DESCRIPTION	NO.	COMMAND	ARGUMENT 1	ARGUMENT 2	ARGUMENT 3	ARGUMENT 4	RESPONSE
Temperature Alarms**	Sets / reads the status of the temperature alarms. Note: High and Low limits have to be entered in the °C. High alarm value has to be more than Low alarm value. Alarm conditions: Temp. > High Limit = H Temp. < Low Limit = L Low < Temp. < High = N	7	TA	H (high flow limit)	<Value> (-10.1-100°C)			TAH:<Value (°C)>
				L (low flow limit)	<Value> (-10.1-100 °C)			TAL:<Value (°C)>
				A (action delay in seconds)	<Value> (0-3600 sec.)			TAA:<Value (sec)>
				E (enable alarm)				TA:E
				D (disable alarm)*				TA:D
				R (read current status)				TA:N (no alarm) TA:H (high alarm) TA: L (low alarm)
				S (Read current settings)				TAS:M,L,H,D,B where: M – mode (E/D) L – Low settings (°C) H – High settings (°C) D – Action Delay (sec) B – Latch mode (0-3)
				B Block (Latch) mode	<Value> (0-disabled*) (1-enabled L) (2-enabled H) (3 –both L,H)			TAB:<Value> where: Value = 0 – 3

COMMAND SYNTAX										
COMMAND NAME	DESCRIPTION	NO.	COMMAND	ARGUMENT 1	ARGUMENT 2	ARGUMENT 3	ARGUMENT 4	RESPONSE		
Optical Outputs	Assigns action of the two optical outputs. The optical output becomes active when the condition specified by an Argument 2 becomes true. Argument 2: D - no action, disabled* FL - low flow alarm FH - high flow alarm FR - Range between High & Low alarms MT - main tot. reading > limit PT - pilot tot. reading > limit TL - low temp. alarm TH - high temp. alarm TR - Range between High & Low temp. alarms MC - Manual On Control DE - Diagnostic Events	8	0	1 (output #1)	D *			O1:D or O2:D		
				2 (output #2)	FL				O1:FL or O2:FL	
					FH					O1:FH or O2:FH
					FR					O1:FR or O2:FR
					MT					O1:MT or O2:MT
					PT					O1:PT or O2:PT
					TL					O1:TL or O2:TL
					TH					O1:TH or O2:TH
					TR					O1:TR or O2:TR
					DE					O1:DE or O2:DE
					MC					O1:MC or O2:MC
					S (read current settings)					Ox:D
				Main Totalizer	Sets and controls action of the Main flow totalizer. NOTE: Main Totalizer reading is stored in EEPROM (non volatile) memory. Power cycle will not affect Main Totalizer reading.	9	MT	Z (Reset to zero)		
F (start totalizer at flow %F.S.)									MTF:<value>	
L (Limit gas volume in current E.U.)										MTL:<value>
D (disable totalizer)*										MT:D
E(enable totalizer)										MT:E
	R(read current totalizer volume)						MTR:<value> (in current EU)			
	S(setting status)						MTS:Mode,Start,Limit			

COMMAND SYNTAX								
COMMAND NAME	DESCRIPTION	NO.	COMMAND	ARGUMENT 1	ARGUMENT 2	ARGUMENT 3	ARGUMENT 4	RESPONSE
Pilot Totalizer	Sets and controls action of the Pilot flow totalizer. NOTE: Pilot Totalizer reading is stored in SRAM (volatile) memory. Power cycle will reset Pilot Totalizer reading to zero.	10	PT	Z (Reset to zero)				PTZ
				F (start totalizer at flow %FS.)	<value> (flow %FS)			PTF:<value>
				L (Limit gas volume in current E.U.)	<value> (gas volume)			PTL:<value>
				D (disable totalizer)*				PT:D
				E (enable totalizer)				PT:E
Low Flow Cut Off	Display /Change Meter Low Flow Cut Off settings in %FS.	11	CO	R (read current totalizer volume)				PTR:<value> (in current EU)
				S (setting status)				PTS: Mode, Start, Limit
				<Cut off Value> (0 to 10.0%)				CO:<Cut off Value> Example: CO:2.0
Fluid Density	Read and set Fluid Density in g/cm3	12	FD	No Argument (Returns Current Cut off Value settings)				CO:<Cut off Value> Example: CO:2.0
				(New Density Value) 0.01 Density 5.0 g/cm3				FD:<value>
				No Argument (Returns Current Density in g/cm3)				FD:<value> Example: FD:1.000

COMMAND NAME	DESCRIPTION	NO.	COMMAND SYNTAX					RESPONSE
			COMMAND	ARGUMENT 1	ARGUMENT 2	ARGUMENT 3	ARGUMENT 4	
				% (% full scale) *				U: %
				mL/sec				U: mL/sec
				mL/min				U: mL/min
				mL/hr				U: mL/hr
				L/sec				U: L/sec
				L/min				U: L/min
				L/hr				U: L/hr
	Set the units of measure for gas flow and totalizer reading.			m3/sec				U: m3/sec
	Note: The units of the totalizer output are not per unit time.			m3/min				U: m3/min
				m3/hr				U: m3/hr
				f3/sec				U: f3/sec
				f3/min				U: f3/min
				f3/hr				U: f3/hr
	For user defined units: k-factor value represents conversion value from L/min.			g/sec				U: g/sec
				g/min				U: g/min
				g/hr				U: g/hr
Units		13	U					U: kg/sec
	Time base argument:			kg/min				U: kg/min
	S – seconds			kg/hr				U: kg/hr
	M – minutes			Lb/sec				U: Lb/sec
	H – hours			Lb/min				U: Lb/min
	Density argument:			Lb/hr				U: Lb/hr
	Y – use density			Gl/sec				U: Gl/sec
	N – do not use density			Gl/min				U: Gl/min
				Gal/hr				U: Gal/hr
				t/sec				U: t/sec
				t/min				U: t/min
				t/hr				U: t/hr
				USER (user defined)				U: USER, <F> <T> <D>
				No Argument (status)				U: <EU name>

COMMAND SYNTAX								
COMMAND NAME	DESCRIPTION	NO.	COMMAND	ARGUMENT 1	ARGUMENT 2	ARGUMENT 3	ARGUMENT 4	RESPONSE
Maintenance Timer	Hours since last time unit was calibrated. NOTE: has to be reset to zero after calibration.	14	C	R (read timer) Z (set timer to zero)				CR:<value> CZ
Pulse Measure Interval	Display/Change Meter Pulse Measure Interval settings Note: Pulse Measure Interval has to be in the range: 500mS MI 60000 mS	15	I	<new value> in mS No Argument (Returns Current MI settings in mS)				I:<value> Example: I:2000 I:<value> Example: I:2000
Flow Measure Mode	Display/Change Meter Flow Measuring Mode Following measurement modes are supported: W - Pulse Width C - Number of Pulses per measure interval	16	MM	<New Mode> W - Pulse Width* C - # of Pulses No Argument (Returns Current settings)				MMI:<value> Example: MM:W MMI:<value> Example: MM:W
Flow Meter Linearizer	Enable/Disable flow meter Linearizer	17	FL	<New Value> E or D No Argument (Returns Current Linearizer settings)				FL:<value> Example: FL:E FL:<value> Example: FL:E
LCD Back Light**	Display/Change LCD Back Light settings Note: LCD Back Light settings has to be in the range: 0% BL 80%	18	BL	(New LCD Back Light value) 0 - 80% No Argument (Returns Current LCD Back Light settings)				BL: <BL Value> Example: BL:50 BL: < BL Value > Example: BL:50

COMMAND SYNTAX								
COMMAND NAME	DESCRIPTION	NO.	COMMAND	ARGUMENT 1	ARGUMENT 2	ARGUMENT 3	ARGUMENT 4	RESPONSE
Noise Reduction Filter	Noise Reduction Filter parameter settings. Following arguments supported: T - Running Average Time Interval (0-99 seconds) N -Running Average Number of samples (1-32)	19	NR	T (time interval) N (number of samples) S (status)				NRT:5 NRN:5 NR:5,5
Read EEPROM Memory	Reads the value in the specified memory location.	20	MR	0 to 100 (Memory Table Index)				<memory value>
Write EEPROM Memory	Writes the specified value to the specified memory location. Use Carefully, can cause unit to malfunction. (Note: Some addresses are write protected!)	21	MW	20 to 100 (Memory Table Index)	Value			MW,XXX,<Value> where: XXX=Table Index Example: MW,100,"Meter#6"

UART Error Codes:

- 1 - Not Supported Command or Back Door is not enabled.
- 2 - Wrong # of Arguments.
- 3 - Address is Out of Range (MR or MW commands).
- 4 - Wrong # of the characters in the Argument.
- 5 - Attempt to Alter Write Protected Area in the EEPROM.
- 6 - Proper Command or Argument is not found.
- 7 - Wrong value of the Argument.
- 8 - Reserved.
- 9 - Manufacture specific info EE KEY (wrong key or key is disabled).

Diagnostic events codes and bit position:

- | | | | |
|----------------------------|---|--------------------------------------|---|
| 1. CPU Temp. High | 0 | 9. Main Totalizer Limit | 8 |
| 2. Flow > 125% F.S. | 1 | 10. Pilot Totalizer Limit | 9 |
| 3. High Flow Alarm | 2 | 11. EEPROM Failure | A |
| 4. Low Flow Alarm | 3 | 12. DC/DC converter Voltage too High | B |
| 5. High Temperature Alarm | 4 | 13. DC/DC converter Voltage too Low | C |
| 6. Low Temperature Alarm | 5 | 14. Communication Error | D |
| 7. Temperature Above Limit | 6 | 15. Reserved | E |
| 8. Temperature Below Limit | 7 | 16. Fatal ERROR | F |

8. TROUBLESHOOTING

8.1 Common Conditions

Your FP1400 Flow Meter was thoroughly checked at numerous quality control points during and after manufacturing and assembly operations. It was calibrated according to your desired flow and pressure conditions for a given fluid. It was carefully packed to prevent damage during shipment. Should you feel that the instrument is not functioning properly, please check for the following common conditions first:

Are all cables connected correctly? Are there any leaks in the installation? Is the power supply correctly selected according to requirements? When several meters are used a power supply with appropriate current rating should be selected. Were the connector pinouts matched properly? When interchanging with other manufacturers' equipment, cables and connectors must be carefully wired for correct pin configurations. Is the pressure differential across the instrument sufficient?

No	INDICATION	LIKELY REASON	SOLUTION
1	LCD Display remains blank when unit is powered up. No response when flow is introduced from analog outputs 0-5 Vdc or 4-20 mA.	Power supply is bad or polarity is reversed.	Measure voltage on pins A and B of the 12 pin M16 connector. If voltage is out of specified range, then replace power supply with a new one. If polarity is reversed (reading is negative) make correct connection.
		PC board is defective.	Return FP1400 to factory for repair.
2	LCD Display reading or /and flow analog output 0-5Vdc signal fluctuate in wide range during flow measurement.	Flow output 0-5 Vdc signal (pin L of the 12 pin M16 connector) is shorted on the GND or overloaded.	Check external connections to pin L of the 12 pin M16 connector. Make sure the load resistance of the equipment connected to the flow 0-5 Vdc output is more than 1000 Ohm.
3	LCD Display reading or /and temperature analog output 0-5Vdc signal fluctuate in wide range during flow measurement.	Temperature output 0-5 Vdc signal (pin M of the 12 pin M16 connector) is shorted on the GND or overloaded.	Check external connections to pin M of the 12 pin M16 connector. Make sure the load resistance of the equipment connected to the flow 0-5 Vdc output is more than 1000 Ohm.
4	LCD Display reading does correspond to the correct flow range, but 0-5 Vdc output signal does not change (always the same reading or around zero).	Output 0-5Vdc schematic is burned out or damaged.	Return FP1400 to factory for repair.
		Analog flow output scale and offset variable are corrupted.	Restore original EEPROM scale and offset variable or perform analog output recalibration (see section 5.2).

No	INDICATION	LIKELY REASON	SOLUTION
5	LCD Display flow reading and 0-5 Vdc output voltage do correspond to the correct flow range, but 4-20 mA output signal does not change (always the same or reading around 4.0 mA).	External loop is open or load resistance more than 500 Ohm.	Check external connections to pins L and K of the 12 pin M16 connector. Make sure the loop resistance is less than 500 Ohm.
		Flow output 4-20 mA schematic is burned out or damaged.	Return FP1400 to factory for repair.
6	LCD Display temperature reading and 0-5 Vdc output voltage do correspond to the correct flow range, but 4-20 mA output signal does not change (always the same or reading around 4.0 mA).	External loop is open or load resistance more than 500 Ohm.	Check external connections to pins M and K of the 12 pin M16 connector. Make sure the loop resistance is less than 500 Ohm
		Temperature output 4-20 mA schematic is burned out or damaged.	Return FP1400 to factory for repair.
7	Fluid flows through the FP1400 meter and Paddle Wheel is turning, but LCD Display reading and the flow output voltage 0-5 Vdc signal do not respond to flow.	The fluid flow rate is below set Low flow cut-off value.	Check settings for Low flow cut-off value and make required adjustment.
		Sensor or PC board is defective.	Return FP1400 to factory for repair.
8	Fluid flows through the FP1400 meter and Paddle Wheel is turning, but LCD Display reading and the flow output voltage 0-5 Vdc signal do not respond to flow. There is no pulse output signals from pin C of the 12 pin M16 connector.	FP1400 magnetic sensor is defective	Replace FP1400 magnetic sensor.
		Paddle Wheel magnets are defective	Replace FP1400 Paddle Wheel
9	The Temperature reading on the LCD and analog 0-5 Vdc or 4-20 mA is not correct (out of the device measurement range: -10 to 70C)	RTD connector got loose and is not connected to the PCB board.	Check RTD connector, make sure it is firmly attached to the header J2 on the PCB.
		RTD sensor is defective	Replace RTD sensor
10	The FP1400 Diagnostic Alarm Event with code 0 – “CPU Temp. High” is active.	MCU temperature is too high (overload).	Disconnect power from the FP1400. Make sure the ambient temperature is within specified range (below 70° C). Let the device cool down for at least 15 minutes. Apply power to the FP1400 and check Diagnostic Alarm Event. If overload condition will be indicated again the unit has to be returned to the factory for repair.
11	The FP1400 Diagnostic Alarm Event with code F - “Fatal Error” is active.	Fatal Error (EEPROM or SRAM corrupted)	Cycle the power on the FP1400. If Diagnostic Alarm Event with code F indicating again the unit has to be returned to the factory for repair.

APPENDIX I

OMEGA® FP1400 Flow Meter EEPROM Variables Rev:A002 [10/01/2009]

Note: indexes 0-19 are write protected (manufacture and calibration specific data)

INDEX	NAME	DATA TYPE	NOTES
0	BlankEEPROM[10]	char[10]	Do not modify. Table Revision [PROTECTED]
1	SerialNumber[20]	char[20]	Serial Number [PROTECTED]
2	ModelNumber[20]	char[20]	Model Number [PROTECTED]
3	SoftwareVer[10]	char[10]	Firmware Version [PROTECTED]
4	ManufReservedF1	float	Manufacture Specific float data [PROTECTED]
5	ManufReservedF2	float	Manufacture Specific float data [PROTECTED]
6	MeterCalFactorM	float	Manufacture Assigned Number of Pulses per Gallon [PROTECTED]
7	MeterSize	float	Size of the meter's flow tube [mm] [PROTECTED]
8	ReservedText[12]	char[12]	Reserved for Manufacture Specific Text Info [PROTECTED]
9	ManufReservedF3	float	Manufacture Specific float data [PROTECTED]
10	ManufReservedF4	float	Manufacture Specific float data [PROTECTED]
11	ManufReservedF5	float	Manufacture Specific float data [PROTECTED]
12	ManufReservedF6	float	Manufacture Specific float data [PROTECTED]
13	ManufReservedUI1	uint	Manufacture Specific uint data [PROTECTED]
14	ManufReservedUI2	uint	Manufacture Specific uint data [PROTECTED]
15	ManufReservedUI3	uint	Manufacture Specific uint data [PROTECTED]
16	ManufReservedUI4	uint	Manufacture Specific uint data [PROTECTED]
17	ManufReservedSI1	int	Manufacture Specific int data [PROTECTED]
18	ManufReservedSI2	int	Manufacture Specific int data [PROTECTED]
19	ManufReservedSI3	int	Manufacture Specific int data [PROTECTED]
20	TimeSinceCalHr	float	Time elapsed since last calibration in hours
21	ProtectionCode	uint	Program Parameters Protection Code [0-255]
22	BackLight	int	Back Light Level [0-4095]**
23	RTD_NRF_TimeLimit	int	RTD NRF Time Interval [0-199], 0 – disabled**
24	LCD_Diagnostic	uint	LCD Diagnostic Mode: [0, 1]
25	Address485	char[4]	Two hexadecimal characters address for RS485 only [01-FF]
26	FlowUnits	int	Current Units of Measure [0-28]
27	AlarmMode	uint	Flow Alarm Mode (0=Disabled, 1=Enabled)
28	LowAlarmPFS	float	Low Flow Alarm Setting [%FS] 0-Disabled
29	HiAlarmPFS	float	High Flow Alarm Setting [%FS] 0-Disabled
30	AlmDelay	uint	Flow Alarm Action Delay [0-3600sec] 0-Disabled
31	RelaySetting	char[4]	Relays Assignment Setting**
32	TotalMode	uint	Totalizer Mode [1- Enabled, 0 - Disabled]

INDEX	NAME	DATA TYPE	NOTES
33	TotalFlowStart	float	Start Main Totalizer at flow [%FS] 0 - Disabled
34	TotalVolStop	float	Main Totalizer Action Limit Volume [%*s] 0- Disabled
35	TotalConfLock	uint	Key Pad Totalizer reset access Lock [0 – Disabled, 1 – Enabled]
36	UDUnitKfactor	float	K-Factor for User Defined Units of Measure
37	UDUnitTimeBase	int	K-Factor = UDUnit/(L/min)
38	UDUnitDensity	uint	User Defined Unit Time Base [1, 60, 3600 sec]
39	FoutScaleV	float	User Defined Unit Density Flag [0-not used, 1 - used]
40	FoutOffsetV	float	Flow Analog 0-5 Vdc Out Scale
41	FoutScalet_mA	float	Flow Analog 0-5 Vdc Out Offset
42	FoutOffset_mA	float	Flow Analog 4-20 mA Out Scale
43	ToutScaleV	float	Temperature Analog 0-5 Vdc Out Scale**
44	ToutOffsetV	float	Temperature Analog 0-5 Vdc Out Offset**
45	ToutScalet_mA	float	Temperature Analog 4-20 mA Out Scale**
46	ToutOffset_mA	float	Temperature Analog 4-20 mA Out Offset**
47	FlowMeasureMode	uint	0-Pulse width measure, 1 - Number of Pulses per measure interval
48	OptOut1_Config	uint	Optical Output #1 Configuration (function) [0-10]
49	OptOut2_Config	uint	Optical Output #2 Configuration (function) [0-10]
50	RTD_LinearMode	uint	RTD Linearizer (0-Disabled, 1-Enabled)**
51	AlarmLatch	uint	Alarm Latch settings [0-3]
52	PTotalMode	uint	Pilot Totalizer mode (0-Disabled, 1-Enabled)
53	RTD_NRF_NSAMPLE	uint	RTD NRF Number of Samples [1 - 32]**
54	PTotalFlowStart	float	Start Pilot Totalizer at flow [%FS] 0 - Disabled
55	PTotalVolStop	float	Pilot Totalizer Action Limit Volume [%*s] 0-Disabled
56	MeterFSRange	float	Meter Full Scale range in L/min
57	LowFlowCutOff	float	Low Flow cut off. Must be between 0 and 10.0 %F.S.
58	Damping	uint	Flow Reading Damping 1-99 seconds
59	Density	float	Fluid Density g/cm ³ [0.01 - 5.00000 g/cm ³]
60	PulseMeasInt	uint	Flow Pulse Measure Interval in mS [500-60000]
61	MeterCalFactor	uint	Calibration Factor: Number of Pulses per Gallon
62	FlowTb[0].FlowPFS	float	Flow Linearizer Index 0 PFS (must be 0.0)
63	FlowTb[0].LinCounts	uint	Flow Linearizer Index 0 Counts (must be 0)
64	FlowTb[1].FlowPFS	float	Flow Linearizer Index 1 PFS [0.0 – 1.0]
65	FlowTb[1].LinCounts	uint	Flow Linearizer Index 1 Counts
66	FlowTb[2].FlowPFS	float	Flow Linearizer Index 2 PFS [0.0 – 1.0]
67	FlowTb[2].LinCounts	uint	Flow Linearizer Index 2 Counts

INDEX	NAME	DATA TYPE	NOTES
68	FlowTbl[3].FlowPFS	float	Flow Linearizer Index 3 PFS [0.0 – 1.0]
69	FlowTbl[3].LinCounts	uint	Flow Linearizer Index 3 Counts
70	FlowTbl[4].FlowPFS	float	Flow Linearizer Index 4 PFS [0.0 – 1.0]
71	FlowTbl[4].LinCounts	uint	Flow Linearizer Index 4 Counts
72	FlowTbl[5].FlowPFS	float	Flow Linearizer Index 5 PFS [0.0 – 1.0]
73	FlowTbl[5].LinCounts	uint	Flow Linearizer Index 5 Counts
74	FlowTbl[6].FlowPFS	float	Flow Linearizer Index 6 PFS [0.0 – 1.0]
75	FlowTbl[6].LinCounts	uint	Flow Linearizer Index 6 Counts
76	FlowTbl[7].FlowPFS	float	Flow Linearizer Index 7 PFS [0.0 – 1.0]
77	FlowTbl[7].LinCounts	uint	Flow Linearizer Index 7 Counts
78	FlowTbl[8].FlowPFS	float	Flow Linearizer Index 8 PFS [0.0 – 1.0]
79	FlowTbl[8].LinCounts	uint	Flow Linearizer Index 8 Counts
80	FlowTbl[9].FlowPFS	float	Flow Linearizer Index 9 PFS [0.0 – 1.0]
81	FlowTbl[9].LinCounts	uint	Flow Linearizer Index 9 Counts
82	FlowTbl[10].FlowPFS	float	Flow Linearizer Index 10 PFS [0.0 – 1.0]
83	FlowTbl[10].LinCounts	uint	Flow Linearizer Index 10 Counts
84	T_InScale	float	Temperature RTD input Scale**
85	T_InOffset	float	Temperature RTD input Offset**
86	T_Mode	float	Reserved**
87	DiagEventMask	uint	Mask for Diagnostic Events: Clear bit-> mask corresponding event. Default mask is 0xFFFFh
88	FlowLinearizer	uint	Flow Linearizer (0=Disabled, 1=Enabled)
89	T_AlarmMode	uint	Temp. Alarm Mode (0=Disabled, 1=Enabled)**
90	T_AlarmDelay	uint	Delay in seconds 0-3600 for Tem.Alarm action**
91	T_AlarmLatch	uint	Temp Alarm Latch 0-3**
92	T_LowAlarm_C	float	Low Temperature Alarm in %FS [-.1-1]**
93	T_HiAlarm_C	float	High Temperature Alarm in %FS [-.1-1]**
94	ReservedF3	float	Reserved
95	FluidName[20]	char[20]	Name of the Liquid used for Calibration
96	CalibratedBy[20]	char[20]	Name of person, meter was calibrated by
97	CalibratedAt[20]	char[20]	Name of the Calibration Lab
98	DateCalibrated[12]	char[12]	Calibration date
99	DateCalibrationDue[12]	char[12]	Date calibration due
100	UserTagName	char[20]	User Defined Device Tag Name or Number
101	EEMagicNumber	uint	Number used to verify EEPROM integrity

** Not supported in some hardware configurations

APPENDIX II

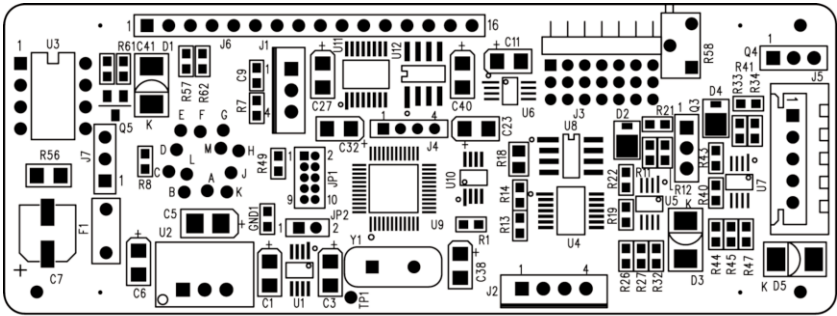

Component Diagram Top Side

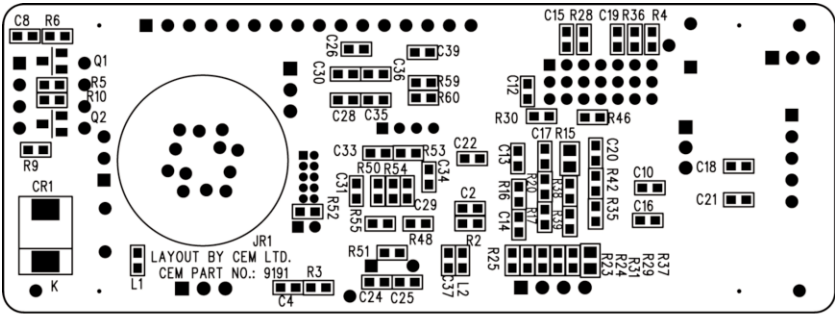

Component Diagram Bottom Side

APPENDIX III

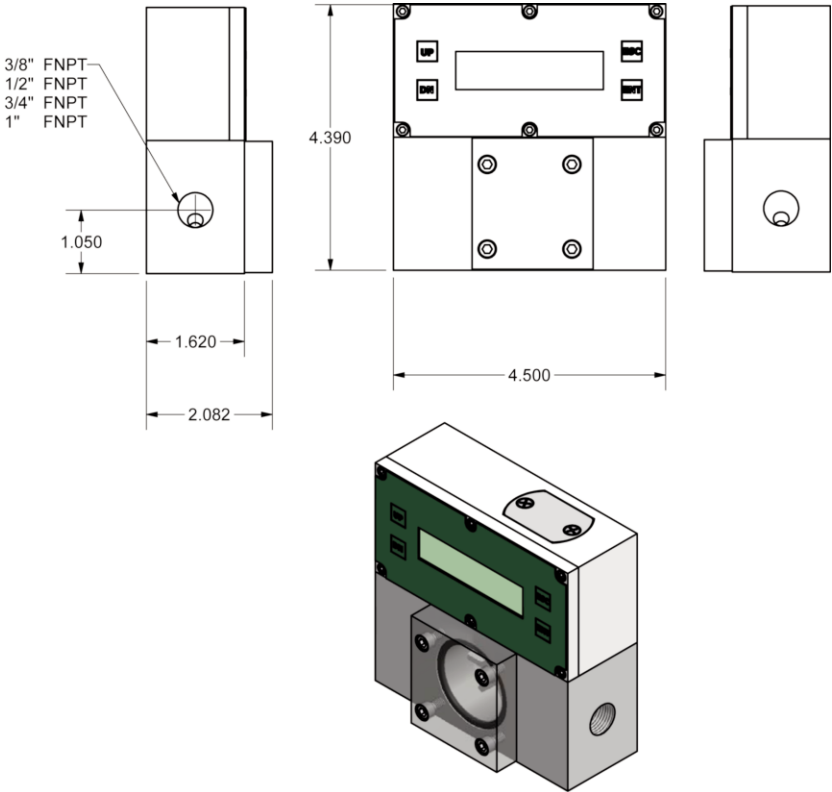

Dimensional Drawing



WARRANTY/DISCLAIMER

OMEGA ENGINEERING, INC. warrants this unit to be free of defects in materials and workmanship for a period of **13 months** from date of purchase. OMEGA's Warranty adds an additional one (1) month grace period to the normal one (1) **year product warranty** to cover handling and shipping time. This ensures that OMEGA's customers receive maximum coverage on each product.

If the unit malfunctions, it must be returned to the factory for evaluation. OMEGA's Customer Service Department will issue an Authorized Return (AR) number immediately upon phone or written request. Upon examination by OMEGA, if the unit is found to be defective, it will be repaired or replaced at no charge. OMEGA's WARRANTY does not apply to defects resulting from any action of the purchaser, including but not limited to mishandling, improper interfacing, operation outside of design limits, improper repair, or unauthorized modification. This WARRANTY is VOID if the unit shows evidence of having been tampered with or shows evidence of having been damaged as a result of excessive corrosion; or current, heat, moisture or vibration; improper specification; misapplication; misuse or other operating conditions outside of OMEGA's control. Components which wear are not warranted, including but not limited to contact points, fuses, and triacs.

OMEGA is pleased to offer suggestions on the use of its various products. However, OMEGA neither assumes responsibility for any omissions or errors nor assumes liability for any damages that result from the use of its products in accordance with information provided by OMEGA, either verbal or written. OMEGA warrants only that the parts manufactured by it will be as specified and free of defects. OMEGA MAKES NO OTHER WARRANTIES OR REPRESENTATIONS OF ANY KIND WHATSOEVER, EXPRESS OR IMPLIED, EXCEPT THAT OF TITLE, AND ALL IMPLIED WARRANTIES INCLUDING ANY WARRANTY OF MERCHANTABILITY AND FITNESS FOR A PARTICULAR PURPOSE ARE HEREBY DISCLAIMED. LIMITATION OF LIABILITY: The remedies of purchaser set forth herein are exclusive, and the total liability of OMEGA with respect to this order, whether based on contract, warranty, negligence, indemnification, strict liability or otherwise, shall not exceed the purchase price of the component upon which liability is based. In no event shall OMEGA be liable for consequential, incidental or special damages.

CONDITIONS: Equipment sold by OMEGA is not intended to be used, nor shall it be used: (1) as a "Basic Component" under 10 CFR 21 (NRC), used in or with any nuclear installation or activity; or (2) in medical applications or used on humans. Should any Product(s) be used in or with any nuclear installation or activity, medical application, used on humans, or misused in any way, OMEGA assumes no responsibility as set forth in our basic WARRANTY / DISCLAIMER language, and, additionally, purchaser will indemnify OMEGA and hold OMEGA harmless from any liability or damage whatsoever arising out of the use of the Product(s) in such a manner.

RETURN REQUESTS/INQUIRIES

Direct all warranty and repair requests/inquiries to the OMEGA Customer Service Department. BEFORE RETURNING ANY PRODUCT(S) TO OMEGA, PURCHASER MUST OBTAIN AN AUTHORIZED RETURN (AR) NUMBER FROM OMEGA'S CUSTOMER SERVICE DEPARTMENT (IN ORDER TO AVOID PROCESSING DELAYS). The assigned AR number should then be marked on the outside of the return package and on any correspondence.

The purchaser is responsible for shipping charges, freight, insurance and proper packaging to prevent breakage in transit.

FOR **WARRANTY** RETURNS, please have the following information available BEFORE contacting OMEGA:

1. Purchase Order number under which the product was PURCHASED,
2. Model and serial number of the product under warranty, and
3. Repair instructions and/or specific problems relative to the product.

FOR **NON-WARRANTY** REPAIRS, consult OMEGA for current repair charges. Have the following information available BEFORE contacting OMEGA:

1. Purchase Order number to cover the COST of the repair,
2. Model and serial number of the product, and
3. Repair instructions and/or specific problems relative to the product.

OMEGA's policy is to make running changes, not model changes, whenever an improvement is possible. This affords our customers the latest in technology and engineering.

OMEGA is a registered trademark of OMEGA ENGINEERING, INC.

© Copyright 2001 OMEGA ENGINEERING, INC. All rights reserved. This document may not be copied, photocopied, reproduced, translated, or reduced to any electronic medium or machine-readable form, in whole or in part, without the prior written consent of OMEGA ENGINEERING, INC.

Where Do I Find Everything I Need for Process Measurement and Control? **OMEGA...Of Course!**

Shop online at www.omega.com

TEMPERATURE

- Thermocouple, RTD & Thermistor Probes, Connectors, Panels & Assemblies
- Wire: Thermocouple, RTD & Thermistor
- Calibrators & Ice Point References
- Recorders, Controllers & Process Monitors
- Infrared Pyrometers

PRESSURE, STRAIN AND FORCE

- Transducers & Strain Gages
- Load Cells & Pressure Gages
- Displacement Transducers
- Instrumentation & Accessories

FLOW/LEVEL

- Rotameters, Gas Mass Flow Meter & Flow Computers
- Air Velocity Indicators
- Turbine/Paddlewheel Systems
- Totalizers & Batch Controllers

pH/CONDUCTIVITY

- pH Electrodes, Testers & Accessories
- Benchtop/Laboratory Meters
- Controllers, Calibrators, Simulators & Pumps
- Industrial pH & Conductivity Equipment

DATA ACQUISITION

- Data Acquisition & Engineering Software
- Communications-Based Acquisition Systems
- Plug-in Cards for Apple, IBM & Compatibles
- Datalogging Systems
- Recorders, Printers & Plotters

HEATERS

- Heating Cable
- Cartridge & Strip Heaters
- Immersion & Band Heaters
- Flexible Heaters
- Laboratory Heaters

ENVIRONMENTAL MONITORING AND CONTROL

- Metering & Control Instrumentation
- Refractometers
- Pumps & Tubing
- Air, Soil & Water Monitors
- Industrial Water & Wastewater Treatment
- pH, Conductivity & Dissolved Oxygen Instruments