

1 YEAR
WARRANTY

Ω OMEGA™ **User's Guide**

***Shop online at
omega.com***

***e-mail: info@omega.com
For latest product manuals:
omega.com/en-us/pdf-manuals***



Series FTB-800 Turbine Flow Meter



omega.com info@omega.com

Servicing North America:

U.S.A.

Headquarters:

Omega Engineering, Inc.

800 Connecticut Ave. Suite 5N01, Norwalk, CT 06854

Toll-Free: 1-800-826-6342 (USA & Canada only)

Customer Service: 1-800-622-2378 (USA & Canada only)

Engineering Service: 1-800-872-9436 (USA & Canada only)

Tel: (203) 359-1660

Fax: (203) 359-7700

e-mail: info@omega.com

GENERAL DESCRIPTION

1.1 Working Principle

When liquid flows through the casing of sensor, the impulse of fluid will provide the blade with a rotation moment as there is an angle between the blade of impeller and the flow direction. The blade will rotate as the friction moment and the fluid resistance are overcome and it will reach a stable speed when the moments are at balance. Under certain conditions, the rotation speed of blade will be in direct proportion to the flow velocity. Due to the magnetic conductivity of blade, when located in the magnetic field generated by signal detector (made of permanent magnet steel and coils), the rotating blade will cut the magnetic lines and periodically change the flux through the coil, thereby inducing electrical impulse signals at both ends of the coil. The induced signals, after amplified and rectified by amplifier, will form a continuous rectangular impulse wave with certain amplitude which may be remotely transmitted to display instrument indicating the instant flow and the cumulative flow of fluid. Within a certain range of flow, the impulse frequency f is in direct proportion to the instant flow of fluid flowing through the sensor.

FEATURES

1. The sensor is of hard alloy bearing thrust type, which may guarantee the precision and improve the wear resistance performance as well.
2. Simple and firm structure, easy for installation and dismantling.
3. Wide range of measuring with very low lower flow velocity limit.
4. Small loss of pressure, fine repeat ability and high precision.
5. High resistance to electromagnetic interference and vibration.

SPECIFICATIONS

MATERIALS OF CONSTRUCTION:

Body: 304 OR 316 Stainless Steel

Rotor: CD4MCU Stainless Steel

Rotor Support and Bearing: 316 Stainless Steel

Rotor Shaft: Tungsten Carbide

OPERATING LIMITATIONS:

Temperature: -20°C to +120°C High temperatures will damage the magnetic pick-up, while lower temperatures will limit the rotation of the rotor.

Pressure: Maximum pressure ratings as follows:

913.5 psi — all NPT meters up to 1"

362.5 psi — 1-1/4", 1-1/2", 2" male NPT

232 psi — 2-1/2", 3", 4" male NPT

WARNING: Pressure in excess of allowable rating may cause the housing to burst and cause serious personal injury.

Accuracy: $\pm 0.5\%$ of reading

Repeatability: $\pm 0.1\%$

Calibration: Water (CNAS Traceable Calibration)

Corrosion: All FTB-800 series turbine meters are constructed of stainless steel and CD4MCU. The operator must ensure that the operating fluid is compatible with these materials. Incompatible fluids can cause deterioration of internal components and cause a reduction in meter accuracy.

Pulsation and

Vibration: Severe pulsation and mechanical vibration will affect accuracy and shorten the life of the meter

Filtration: If small particles are present in the fluid, it is recommended that a strainer be installed upstream of the meter

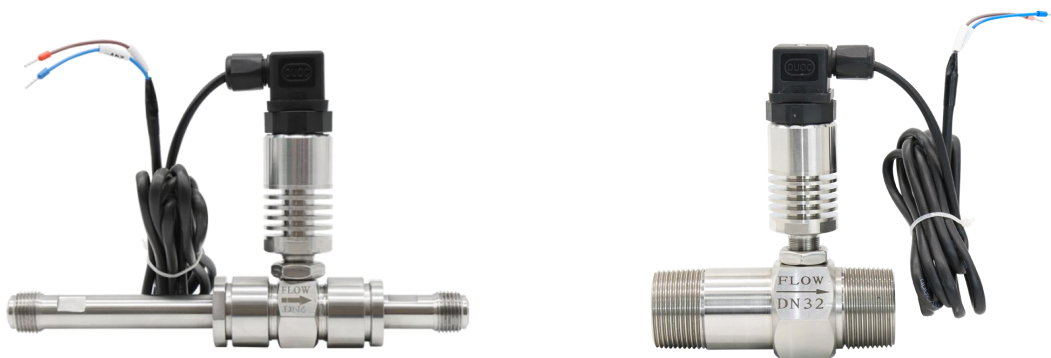

Output: 4 to 20mA output

Two wires from the flow sensor, 24V+ and 24V-, connect other instrument which can supply 24VDC.

Overall Dimension

Turbine Flow sensor Dimensions: mm

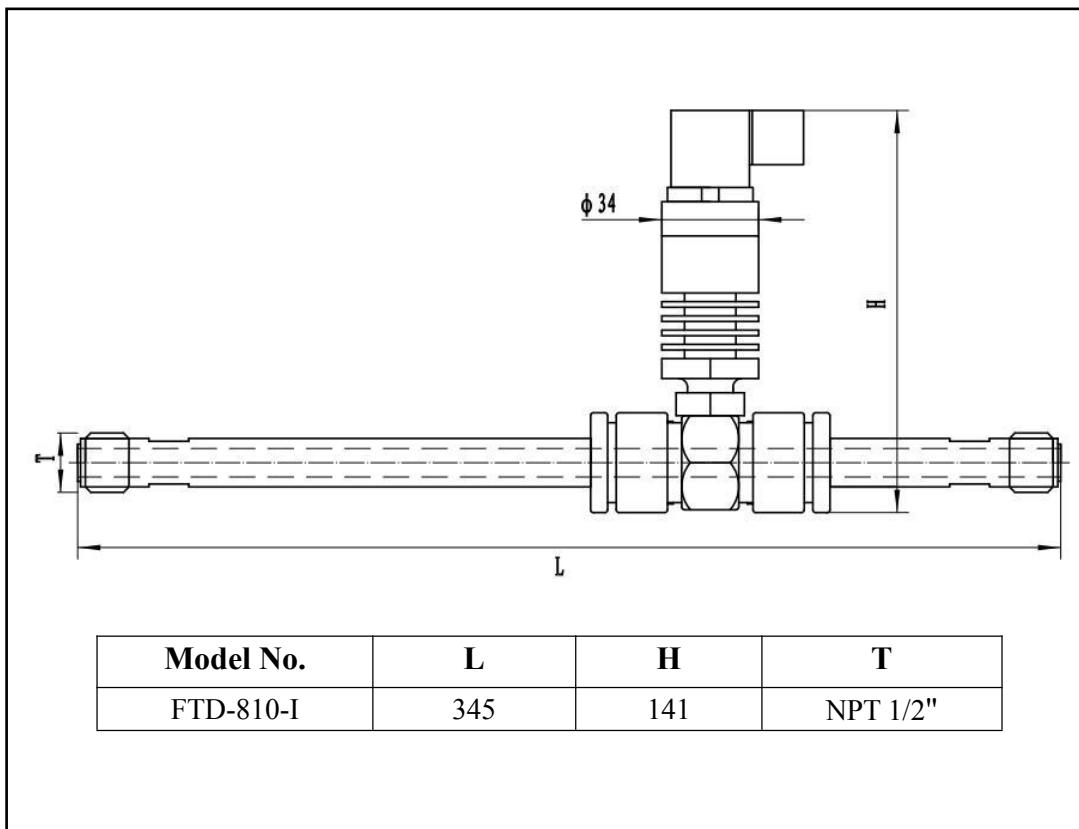
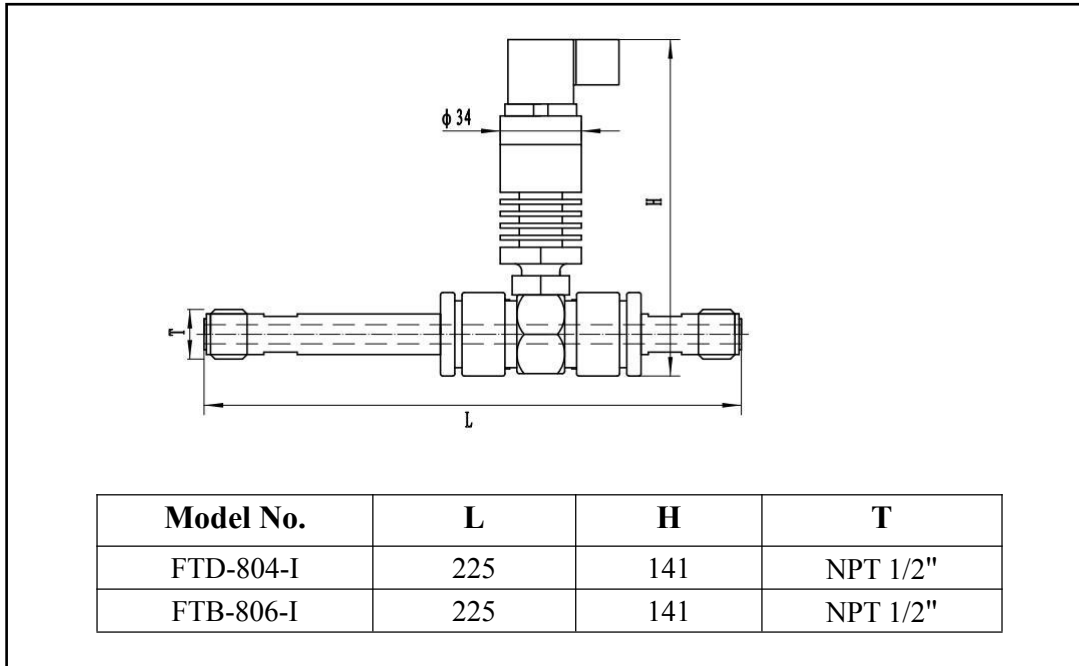

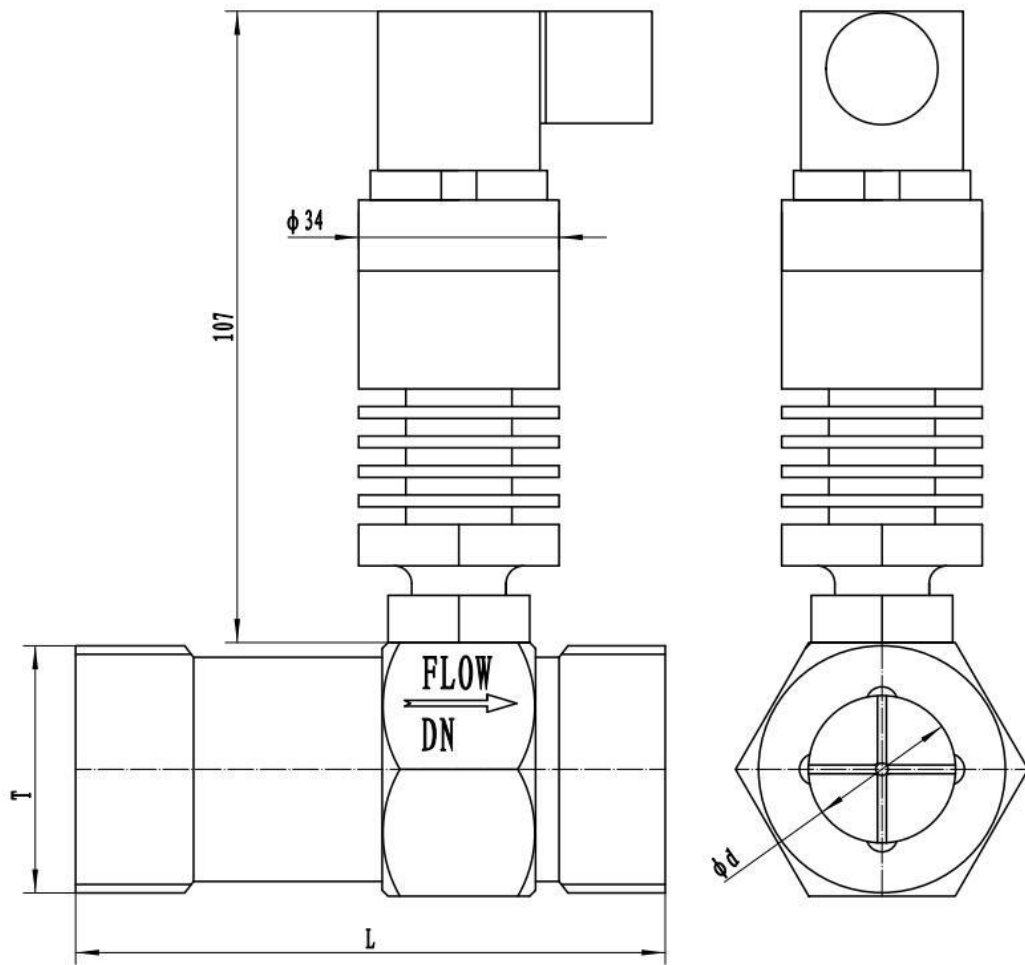

| Model No. | L | d | T |
|-----------|-----|-----|------------|
| FTB-815-I | 75 | 15 | NPT1" |
| FTB-830-I | 120 | 32 | NPT1-1/2" |
| FTB-840-I | 140 | 40 | NPT 2" |
| FTB-860-I | 175 | 65 | NPT 3" |
| FTB-870-I | 200 | 80 | NPT 3-1/2" |
| FTB-880-I | 220 | 100 | NPT4- 1/2" |

Installation Requirements

Flow meter may be installed horizontally or vertically. In the latter case the fluid shall be flowing from downward and fulfill the pipe to avoid bubbles; the flowing direction of liquid shall be consistent with the direction indicated by the arrow on casing of the sensor; as far as front and rear straight pipe sections are concerned (see Fig. 6), at upstream there shall be front straight pipe section at least 10 times of nominal drift diameter in length and at downstream no less than 5 times of nominal drift diameter in length. The internal wall of pipe sections shall be smooth and clean, free of defects such as indent, fouling and peeling. The pipe axis of the sensor shall be aligned with that of the neighboring pipe and the washers used for connection and sealing may not be embedded into depth of the pipe cavity; the sensors shall be kept away from foreign electric field and magnetic

field, effective shielding measures shall be taken in case of necessity to avoid external interference.

In order that the normal transfer of liquid will not be affected by maintenance, it is recommended that bypass pipes be installed at position of sensor.

In case of open air installation, water proof measures shall be taken for purpose of amplifier and plug of the sensor. The wiring between sensor and display instrument is shown in Fig. 5.

When fluid contains impurities, filter shall be additionally installed. The number of filter screen meshes is determined in accordance with the flow and impurity, normally 20 to 60 meshes. When fluid is mixed with free gases, gas eliminator shall be additionally installed. The complete pipe system shall be well sealed. The user shall fully understand the erosion nature of the measured medium to protect the sensor from being eroded.

Fig. 6 Requirements on straight pipe section for installation of flow meter

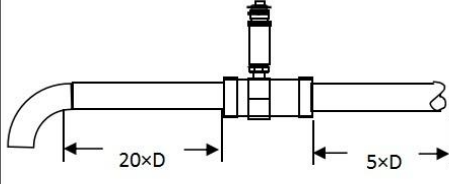
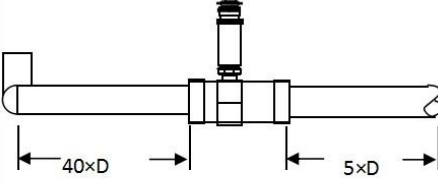
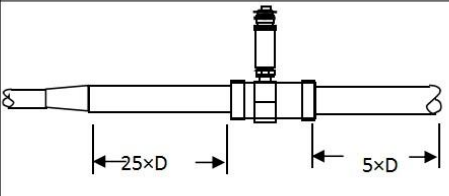
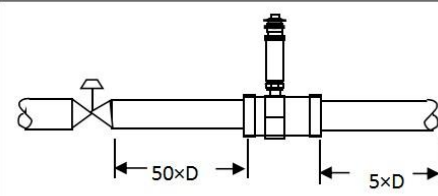
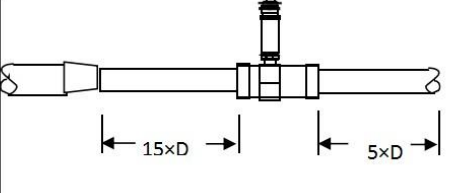
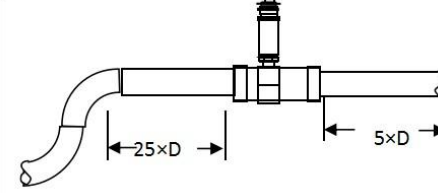
| | | | |
|--------------------------------------|---|-------------------------------|--|
| One 90° elbow |  | Two 90° elbows for two planes |  |
| Concentric expansion |  | Control valve half-open |  |
| Concentric shrinkage wide open valve |  | Two 90° elbows for one plane |  |

Operation

- ◆ When sensor is used, the liquid to be measured shall be clean and free of impurities such as fiber and granules.
- ◆ When sensor is used, it shall be at first slowly filled with liquid, then open the outlet valve (which should be installed behind the flow meter). It is prohibited to render the sensor under impact of high-velocity fluid when it is not filled with liquid.
- ◆ The maintenance interval for sensor is in general half a year. In case of maintenance and cleaning, attention shall be paid not to damage the parts in the measuring cavity, particularly the impeller. During assembly, watch carefully the positional relation between guide part and impeller.
- ◆ When the sensor will be out of service for a long time, the internal liquid shall be cleaned. After dried, the sensor shall be provided with protection sleeves at both ends to protect against dust and it shall be placed in dry conditions for storage.
- ◆ The associated filter shall be cleaned on regular basis and the internal liquid shall be cleaned when it is out of service for a long time. Similar to sensor, the filter shall also be provided with dust protection and stored in dry conditions.
- ◆ The transmission wire of sensor may be overhead or buried (iron bushing shall be provided in the latter case).
- ◆ Prior to installation of sensor, the connection thereof with display instrument or oscilloscope shall be finished. Then switch on the power, blow the impeller or move the impeller with hand to make it rotate quickly, see if there is a reading. Install the sensor if there is reading. In case of no reading, the related sections shall be inspected to eliminate any fault.

WARRANTY/DISCLAIMER

OMEGA ENGINEERING, INC. warrants this unit to be free of defects in materials and workmanship for a period of **13 months** from date of purchase. OMEGA's WARRANTY adds an additional one (1) month grace period to the normal **one (1) year product warranty** to cover handling and shipping time. This ensures that OMEGA's customers receive maximum coverage on each product.

If the unit malfunctions, it must be returned to the factory for evaluation. OMEGA's Customer Service Department will issue an Authorized Return (AR) number immediately upon phone or written request. Upon examination by OMEGA, if the unit is found to be defective, it will be repaired or replaced at no charge. OMEGA's WARRANTY does not apply to defects resulting from any action of the purchaser, including but not limited to mishandling, improper interfacing, operation outside of design limits, improper repair, or unauthorized modification. This WARRANTY is VOID if the unit shows evidence of having been tampered with or shows evidence of having been damaged as a result of excessive corrosion; or current, heat, moisture or vibration; improper specification; misapplication; misuse or other operating conditions outside of OMEGA's control. Components in which wear is not warranted, include but are not limited to contact points, fuses, and triacs.

OMEGA is pleased to offer suggestions on the use of its various products. However, OMEGA neither assumes responsibility for any omissions or errors nor assumes liability for any damages that result from the use of its products in accordance with information provided by OMEGA, either verbal or written. OMEGA warrants only that the parts manufactured by it will be as specified and free of defects. OMEGA MAKES NO OTHER WARRANTIES OR REPRESENTATIONS OF ANY KIND WHATSOEVER, EXPRESS OR IMPLIED, EXCEPT THAT OF TITLE, AND ALL IMPLIED WARRANTIES INCLUDING ANY WARRANTY OF MERCHANTABILITY AND FITNESS FOR A PARTICULAR PURPOSE ARE HEREBY DISCLAIMED. LIMITATION OF LIABILITY: The remedies of purchaser set forth herein are exclusive, and the total liability of OMEGA with respect to this order, whether based on contract, warranty, negligence, indemnification, strict liability or otherwise, shall not exceed the purchase price of the component upon which liability is based. In no event shall OMEGA be liable for consequential, incidental or special damages.

CONDITIONS: Equipment sold by OMEGA is not intended to be used, nor shall it be used: (1) as a "Basic Component" under 10 CFR 21 (NRC), used in or with any nuclear installation or activity; or (2) in medical applications or used on humans. Should any Product(s) be used in or with any nuclear installation or activity, medical application, used on humans, or misused in any way, OMEGA assumes no responsibility as set forth in our basic WARRANTY/DISCLAIMER language, and, additionally, purchaser will indemnify OMEGA and hold OMEGA harmless from any liability or damage whatsoever arising out of the use of the Product(s) in such a manner.

RETURN REQUESTS/INQUIRIES

Direct all warranty and repair requests/inquiries to the OMEGA Customer Service Department. BEFORE RETURNING ANY PRODUCT(S) TO OMEGA, PURCHASER MUST OBTAIN AN AUTHORIZED RETURN (AR) NUMBER FROM OMEGA'S CUSTOMER SERVICE DEPARTMENT (IN ORDER TO AVOID PROCESSING DELAYS). The assigned AR number should then be marked on the outside of the return package and on any correspondence.

The purchaser is responsible for shipping charges, freight, insurance and proper packaging to prevent breakage in transit.

FOR **WARRANTY** RETURNS, please have the following information available BEFORE contacting OMEGA:

1. Purchase Order number under which the product was PURCHASED,
2. Model and serial number of the product under warranty, and
3. Repair instructions and/or specific problems relative to the product.

FOR **NON-WARRANTY** REPAIRS, consult OMEGA for current repair charges. Have the following information available BEFORE contacting OMEGA:

1. Purchase Order number to cover the COST of the repair,
2. Model and serial number of the product, and
3. Repair instructions and/or specific problems relative to the product.

OMEGA's policy is to make running changes, not model changes, whenever an improvement is possible. This affords our customers the latest in technology and engineering.

OMEGA is a trademark of OMEGA ENGINEERING, INC.

© Copyright 2019 OMEGA ENGINEERING, INC. All rights reserved. This document may not be copied, photocopied, reproduced, translated, or reduced to any electronic medium or machine-readable form, in whole or in part, without the prior written consent of OMEGA ENGINEERING, INC.

Where Do I Find Everything I Need for Process Measurement and Control? **OMEGA...Of Course!** *Shop online at omega.com*

TEMPERATURE

- ☑ Thermocouple, RTD & Thermistor Probes, Connectors, Panels & Assemblies
- ☑ Wire: Thermocouple, RTD & Thermistor
- ☑ Calibrators & Ice Point References
- ☑ Recorders, Controllers & Process Monitors
- ☑ Infrared Pyrometers

PRESSURE, STRAIN AND FORCE

- ☑ Transducers & Strain Gages
- ☑ Load Cells & Pressure Gages
- ☑ Displacement Transducers
- ☑ Instrumentation & Accessories

FLOW/LEVEL

- ☑ Rotameters, Gas Mass Flowmeters & Flow Computers
- ☑ Air Velocity Indicators
- ☑ Turbine/Paddlewheel Systems
- ☑ Totalizers & Batch Controllers

pH/CONDUCTIVITY

- ☑ pH Electrodes, Testers & Accessories
- ☑ Benchtop/Laboratory Meters
- ☑ Controllers, Calibrators, Simulators & Pumps
- ☑ Industrial pH & Conductivity Equipment

DATA ACQUISITION

- ☑ Communications-Based Acquisition Systems
- ☑ Data Logging Systems
- ☑ Wireless Sensors, Transmitters, & Receivers
- ☑ Signal Conditioners
- ☑ Data Acquisition Software

HEATERS

- ☑ Heating Cable
- ☑ Cartridge & Strip Heaters
- ☑ Immersion & Band Heaters
- ☑ Flexible Heaters
- ☑ Laboratory Heaters

ENVIRONMENTAL MONITORING AND CONTROL

- ☑ Metering & Control Instrumentation
- ☑ Refractometers
- ☑ Pumps & Tubing
- ☑ Air, Soil & Water Monitors
- ☑ Industrial Water & Wastewater Treatment
- ☑ pH, Conductivity & Dissolved Oxygen Instruments