



PX3005

Rangeable Industrial Pressure Transmitter

M-5721/1018

INSTRUCTION
SHEET

Shop online at omega.com e-mail: info@omega.com
For latest product manuals: omegamanual.info

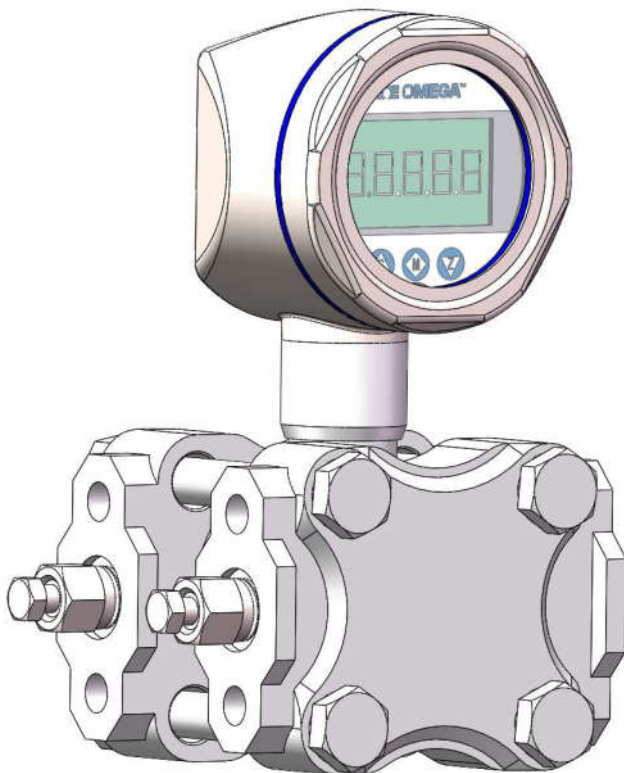

Safety precautions

- ⚠ Pressure / differential pressure transmitter should be installed by professional engineers or qualified technical personnel. The product specifications and important information provided on the label should be carefully read before installation and wiring operations.
- ⚠ Pressure / differential pressure transmitter is powered by an external power supply. The power supply circuit should comply with energy-limiting circuit by relevant standards, and pay attention to the high voltage circuits that may exist.
- ⚠ The maximum static pressure overload has been stated on the product label, the process maximum pressure should not exceed the full span of sensor.
- ⚠ When using pressure / differential pressure transmitter in hazardous areas, installation, use and maintenance should also comply with the operation manual and relevant requirements of national standards.
- ⚠ Attention please! Disassemble the instruments under the condition of normal atmospheric pressure only.

Product usage

Pipeline pressure measurement-pressure transmitter



For high-temperature steam measuring, cooling water should be pre-injected in the condenser filling the tube more than half way. After the steam pipes are stable, slowly open the shut-off valve to start measuring.

Pipeline pressure measurement-differential pressure transmitter

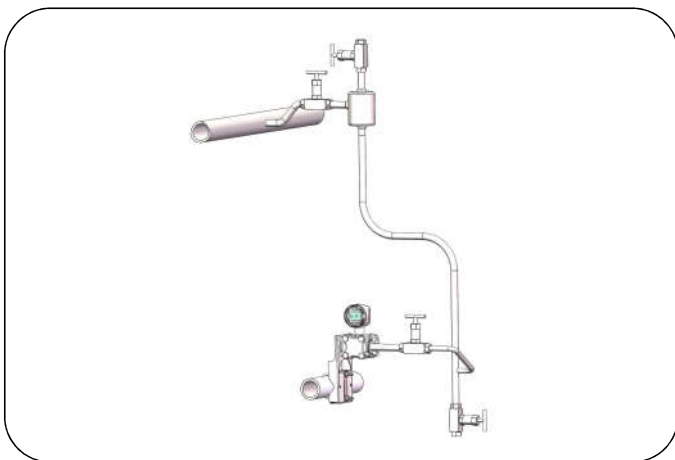

For high-temperature steam measuring, cooling water should be pre-injected into the guided pipe. After the steam pipes are stable, slowly open the shut-off valve to start measuring.

Differential pressure measurement



Differential pressure transmitter is especially suitable for micro pressure measurement of hydrostatic pressure such as filter and equipment leakage test and improving accuracy.

Steam flow measurement

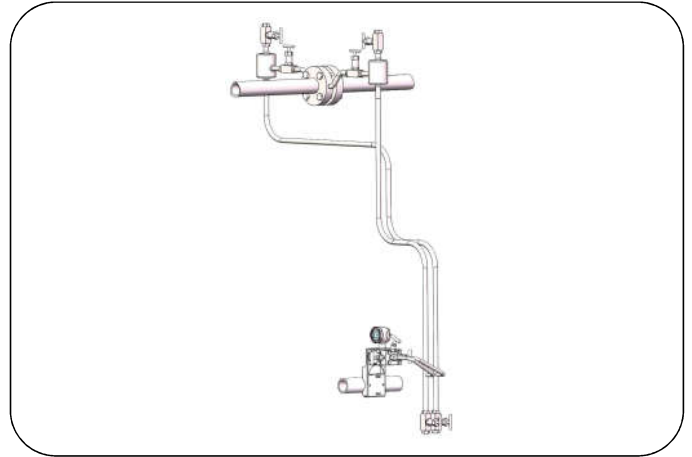

The pressure tube should be tilted up 45°, the installation location should be lower than the process pipeline. Isolation tank and multiple shut-off valves should be used. Cooling liquid should be pre-injected into the guiding pressure tube. The drain/vent valve should be opened periodically, clearing the residual gas and liquid in the guiding pressure tube to ensure accuracy.

Liquid flow measurement

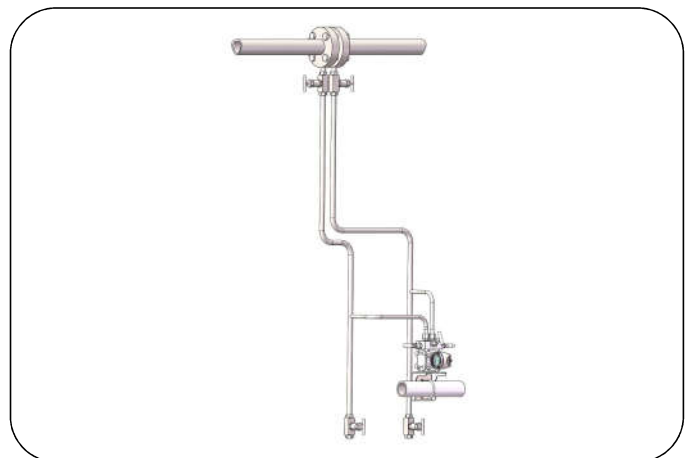

The pressure tube should be tilted down 45°, the installation location should be lower than the process pipeline. Isolation tank and multiple shut-off valves should be used. Open the drain/vent valve periodically to clear the residual gas and liquid in the guiding pressure tube to ensure accuracy.

Air flow measurement



The pressure tube should be tilted up 45°, the installation location should be lower than the process pipeline. Isolation tank and multiple shut-off valves should be used. Open the drain/vent valve periodically to clear the residual gas and liquid in the guiding pressure tube to ensure accuracy.

Sealed container level measurement



For sealed container level measurement, isolation tank and multiple shut-off valves should be used. Open the drain/vent valve periodically to clear the residual gas and liquid in the guiding pressure tube to ensure accuracy.

Open container level measurement-single flange level transmitter

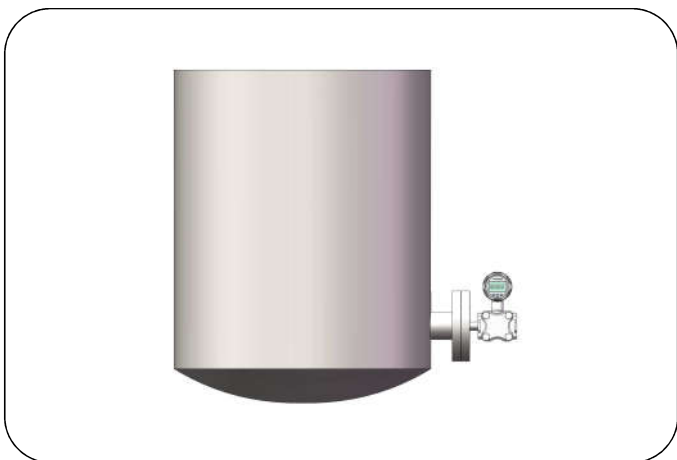

For open container level measurement, media compatibility should be considered, install on location where the liquid level and temperature changes stably to improve accuracy.

Sealed container level measurement-single flange level transmitter

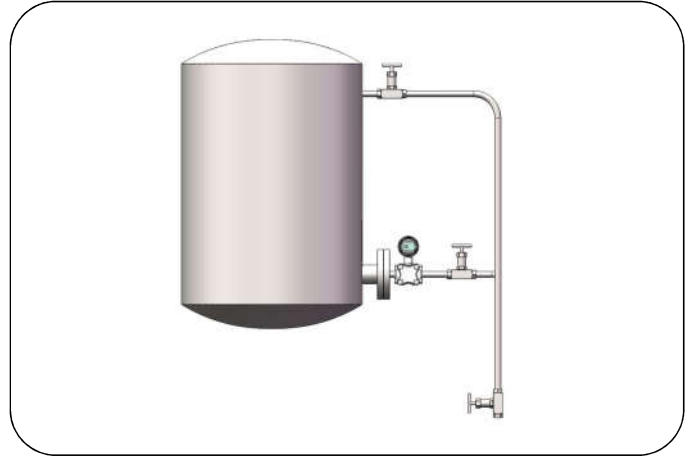

When single flange diaphragm system is used for sealed container level measurement, Isolation tank and multiple shut-off valves should be used, open the drain/vent valve periodically, clear the residual gas and liquid in the guiding pressure tube to ensure accuracy.

⚠ Media in process pipeline or guiding pressure tube may be affected by the surrounding environment, and may freeze. So anti-freezing measures are needed.

Install pressure transmitter

Differential pressure transmitter-bracket installation

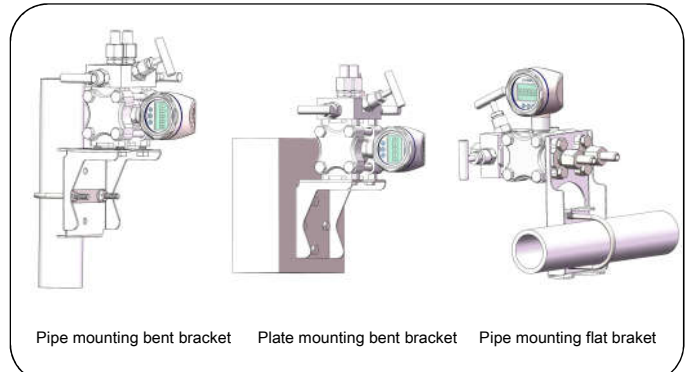

Process connection

Straight thread connection

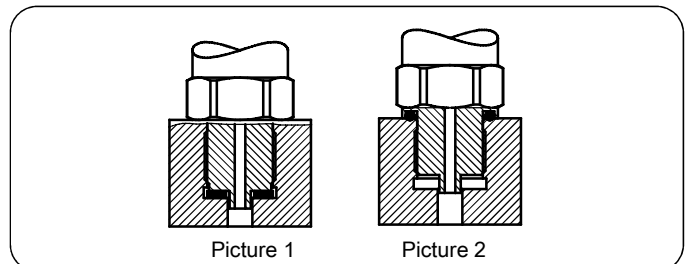

Picture 1: The length of pressure transmitter thread should be longer than the depth of the thread to ensure the seal of head face gasket is effective.

Picture 2: The length of pressure transmitter thread should be shorter than the depth of the thread to ensure the seal of root gasket is effective.

Taper thread connection

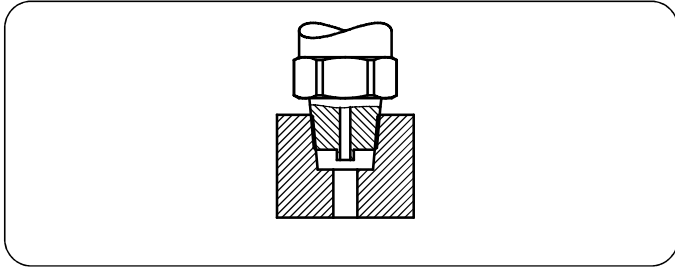

1. Inspect port and fitting to ensure that both are free of contaminants and excessive burrs and nicks.
2. Apply a stripe of an anaerobic liquid pipe sealant around the male threads leaving the first two threads uncovered. If no liquid sealant is available, wrap PTFE tape 1-1/2 turns in a clockwise direction, viewed from the pipe end, leaving the first two threads uncovered.

CAUTION: Follow manufacturer's recommendations for proper application of any sealant to prevent contamination.

3: Screw finger tight into the port.

4: Wrench tighten the fitting 1.5 to 3 Turns Past Finger Tight, TPFT. Consider final orientation position of display, as to not exceed the recommended TPFT. Total thread engagement should be 3.5 to 6 turns.

CAUTION: Never back out components to achieve proper alignment. Loosening will corrupt the seal and contribute to leakage and failure.

Flange connection

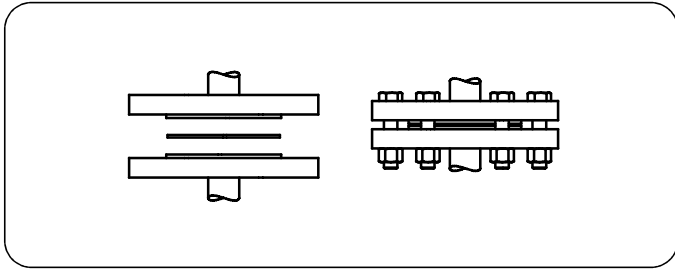

Choose gasket according to medium features and temperature range, pay attention to the bolt balance lock.

Clamp connection

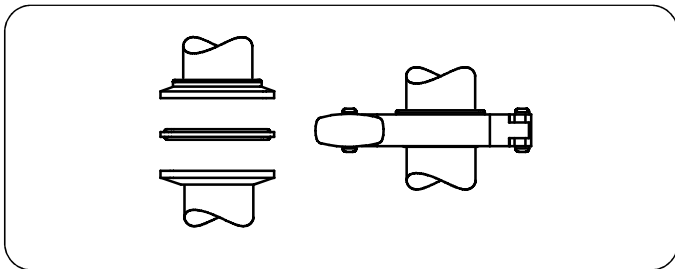

Choose gaskets which meet the health standards, to avoid excessive locking clamp and squeeze gasket and diaphragm and cause measuring error.

Electrical connection

Aviation plug (M12*1 - 4 pins)

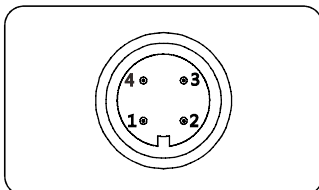

Label	Two wires
1	Power+
2	
3	
4	Power-

Signal connection

4-20mA two wires (aviation plug with cable)

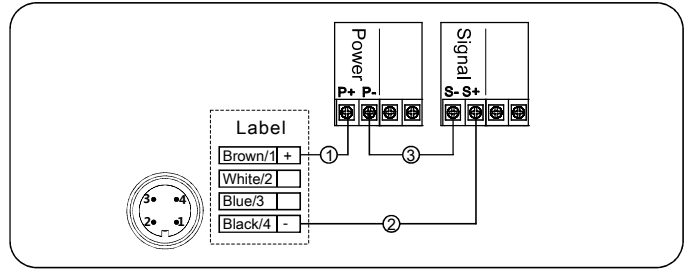

- ① Power supply+ is connected with transmitter terminal 1/brown cable.
- ② Signal+ is connected with transmitter terminals 4/black cable.
- ③ Signal- is connected with power supply-.

Power supply

It is recommended to use an independent linear direct-current power supply. Verify that the combined loop resistances (signal cable, display meter, and other equipment) are not too high, so that the voltage supplied to the pressure transmitter meets the normal operating requirements.

- Standard current signal output: 12-30VDC.

Grounding

- Using cable with shielded twisted-pair signal has the best effect. To avoid ground loop, shielded layer adopts single-end grounded.
- Transient protection is effective only in the case of good grounding. Metal shell and internal grounding terminals are used to the nearest ground directly.

Field adjustment



Range can be adjusted with LCD buttons. For detailed operation, please refer to instructions.

Zero point adjustment

- Please make an adjustment after installation because the mounting position will affect zero setting.
 - The vessel is absolutely empty (No pressure or medium on the measuring diaphragm, the vessel connect to the atmospheric air).
 - Power connection please refer to LCD function instructions-keyboard shortcuts-PV=0.
 - Please set PV=0 after three weeks of installation to ensure the best accuracy.
 - Set PV=0 each year.
- ⚠ Zero point adjustment is only available for gauge pressure transmitter.**

Full span adjustment

- Fill the vessel with medium (fill to the required level).
- The static pressure value should be within the minimum and the maximum pressure range.
- Power connection please refer to LCD function instructions.

Factory resets

- Please refer to LCD function instructions.

Maintenance

Requires no maintenance.

External cleaning

Please notice the following when cleaning:

- Use washing agent which will not damage the instruments.
- Prevent the process diaphragm from mechanical damage, eg: the mechanical damage caused by sharp objects.
- Mechanical cleaning of metal diaphragm is prohibited.
- Do not point the nozzles to the diaphragm directly when doing internal cleaning by pressure washer.

Transportation / storage

- Do not store outside.
- Keep dry and dust-free.
- Do not expose to the corrosive medium.
- Avoid solar radiation.
- Avoid mechanical shock and vibration.
- Storage temperature: -40-85°C.
- Maximum relative humidity: 95%.

EMC statement

- This pressure transmitter conforms to 2014/30/EU EMC standard and bears the CE mark.
- Users need to ensure that all equipment conform to all the applicable standards.

Retransport

- Remove all media from surfaces of the pressure transmitter. Always refer safety data sheet for proper personal protection equipment when handling dangerous medium!
- Please adopt proper package to avoid damage in transportation.

Discard disposal

- The instrument is not restrained by WEEE instruction 2002/96/EG and laws of relevant countries.
- Please pass the instrument to specialized recycling companies other than local recycling points.

LCD function

Prior to commissioning, use the display module to setup all the parameters according to the site configuration.

Products with LCD



The display module of products with LCD can be viewed through the lenses.

Openings in safe area



Adjustments to operating parameters can be done by removing the protective cover. When commissioning is complete, replace cover, taking care not to cross thread, and tighten snugly by hand.

Keys operation

For example, factory setting parameters; pressure range -10-100kPa, display unit mA, operate in the atmosphere.

Set PV=0

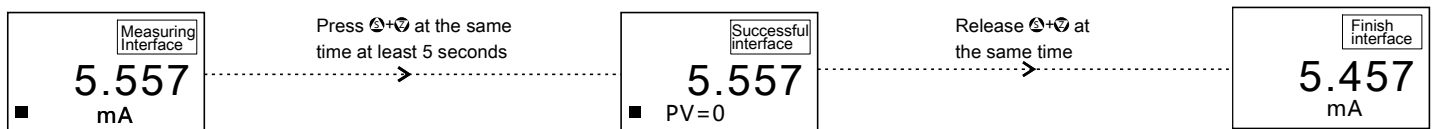

4mA re-range with pressure

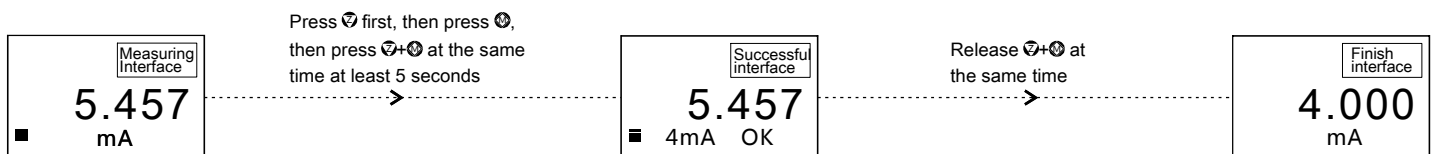

20mA re-range with pressure

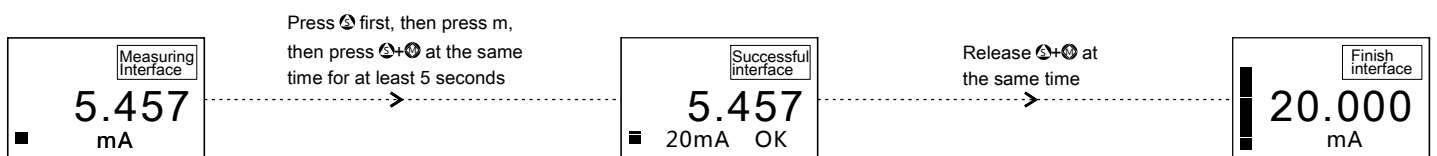

Factory reset

Method 1:

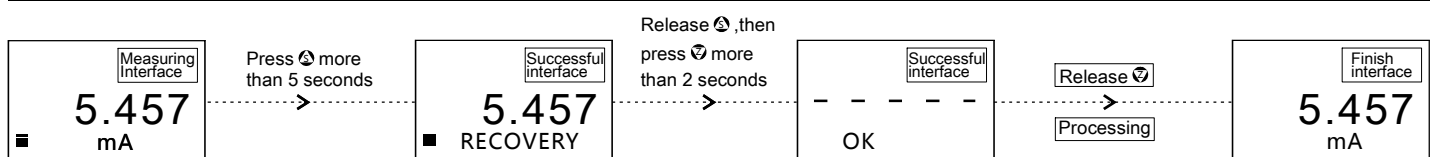

Method 2:

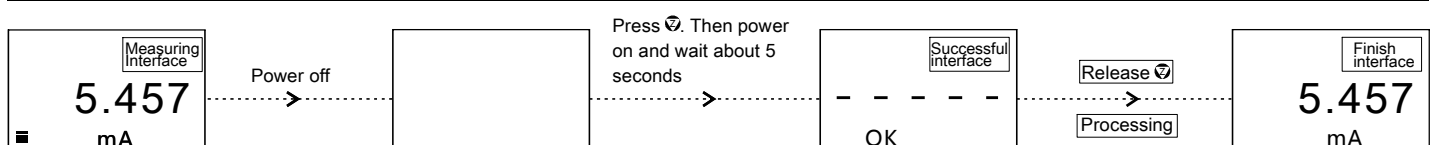

Detailed operating instructions

Measuring Interface

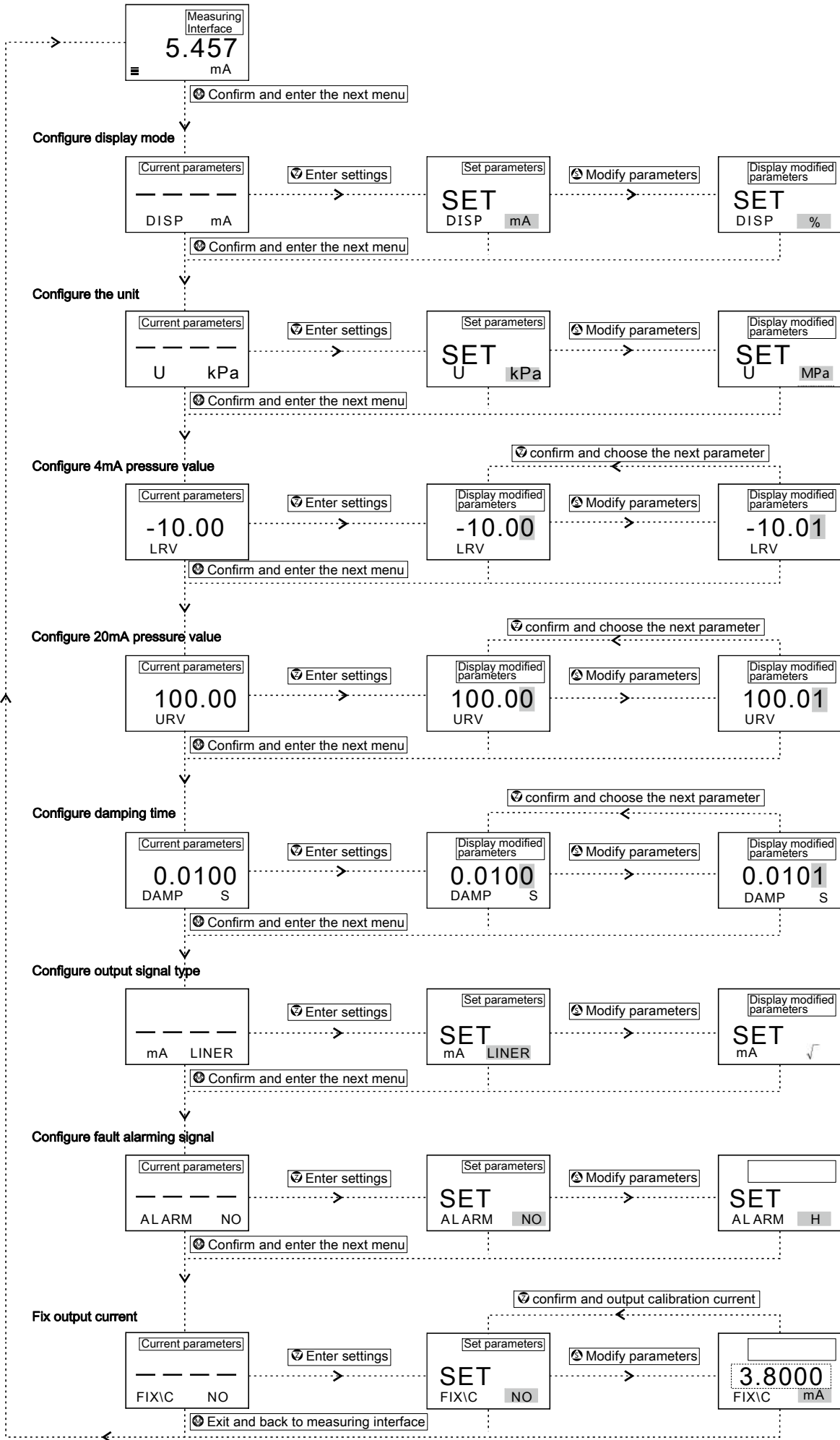

Parameters table

Display mode	
%	Percentage
PV	Process variable
mA	Current

Units (↺, ↻, ↷)	
kPa	
MPa	
bar	
psi	
mmHg	
mmH2O	
mH2O	
inH2O	
ftH2O	
inHg	
mHg	
TORR	
mbar	
g/cm2	
kg/cm2	
Pa	
ATM	
mm	
m	

Lower range value
-19999-99999

Upper range value
-19999-99999

Damping time
0-100S

Output signal type	
<input checked="" type="checkbox"/>	Squar root
<input type="checkbox"/>	Linearity

Fault alarm signal	
N O	None
H	20.8mA
L	3.8mA

Output current
NO (none)
3.8000 mA
4.0000 mA
8.0000 mA
12.000 mA
16.000 mA
20.000 mA
20.800 mA

Display hidden menu

Display hidden menus

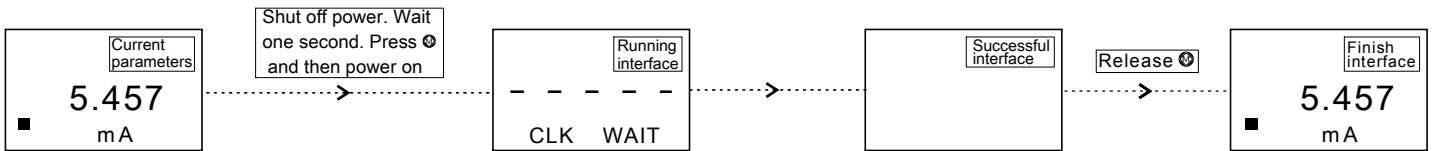

Detailed operation instructions

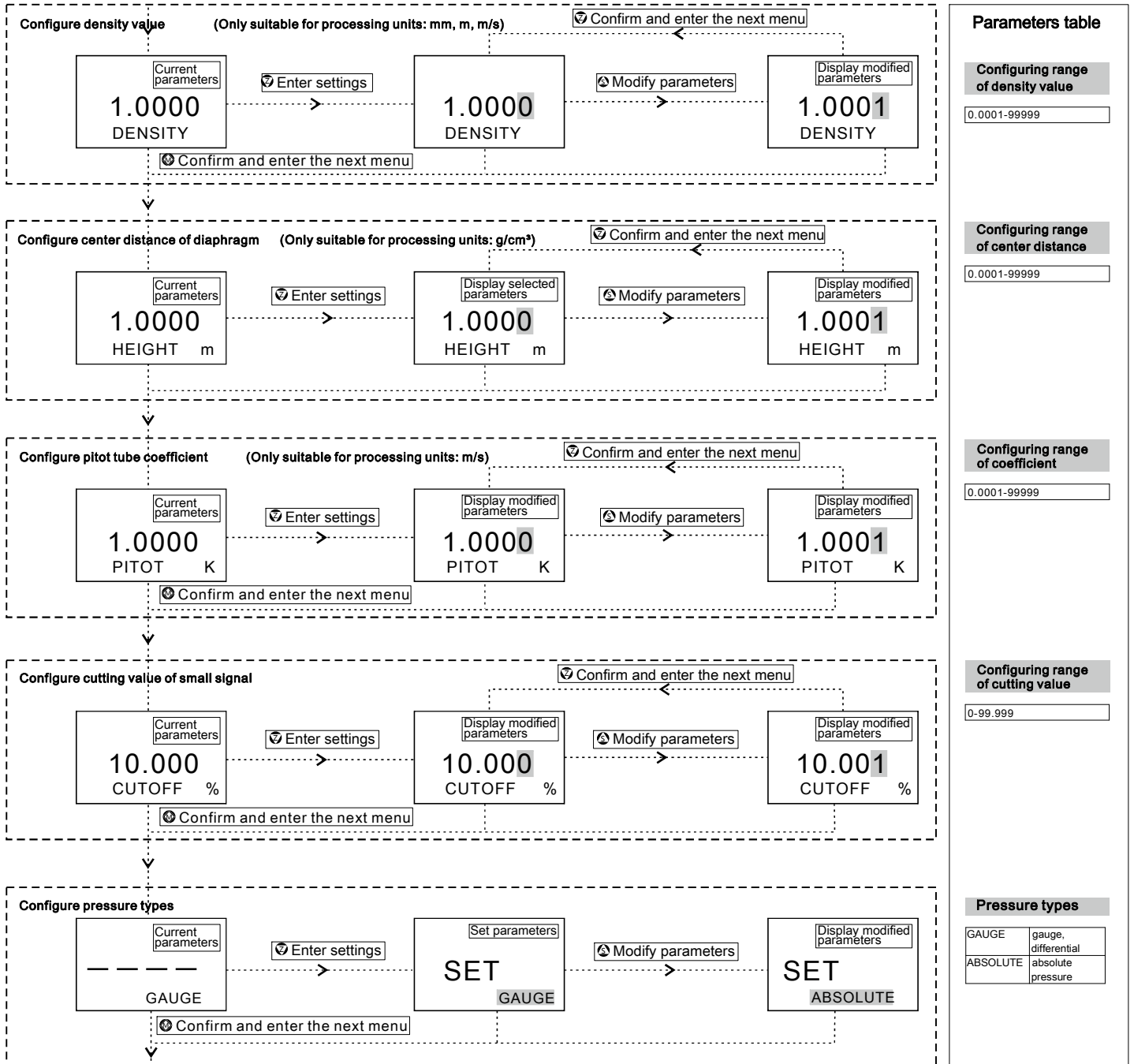



omega.com info@omega.com

Servicing North America:

U.S.A. Headquarters:

Omega Engineering, Inc.
Toll-Free: 1-800-826-6342 (USA & Canada only)
Customer Service: 1-800-622-2378 (USA & Canada only)
Engineering Service: 1-800-872-9436 (USA & Canada only)
Tel: (203) 359-1660 Fax: (203) 359-7700
e-mail: info@omega.com

For Other Locations Visit omega.com/worldwide

The information contained in this document is believed to be correct, but OMEGA accepts no liability for any errors it contains, and reserves the right to alter specifications without notice.

WARRANTY/DISCLAIMER

OMEGA ENGINEERING, INC. warrants this unit to be free of defects in materials and workmanship for a period of **13 months** from date of purchase. OMEGA's WARRANTY adds an additional one (1) month grace period to the normal **one (1) year product warranty** to cover handling and shipping time. This ensures that OMEGA's customers receive maximum coverage on each product.

If the unit malfunctions, it must be returned to the factory for evaluation. OMEGA's Customer Service Department will issue an Authorized Return (AR) number immediately upon phone or written request. Upon examination by OMEGA, if the unit is found to be defective, it will be repaired or replaced at no charge. OMEGA's WARRANTY does not apply to defects resulting from any action of the purchaser, including but not limited to mishandling, improper interfacing, operation outside of design limits, improper repair, or unauthorized modification. This WARRANTY is VOID if the unit shows evidence of having been tampered with or shows evidence of having been damaged as a result of excessive corrosion; or current, heat, moisture or vibration; improper specification; misapplication; misuse or other operating conditions outside of OMEGA's control. Components in which wear is not warranted, include but are not limited to contact points, fuses, and triacs.

OMEGA is pleased to offer suggestions on the use of its various products. However, OMEGA neither assumes responsibility for any omissions or errors nor assumes liability for any damages that result from the use of its products in accordance with information provided by OMEGA, either verbal or written. OMEGA warrants only that the parts manufactured by the company will be as specified and free of defects. OMEGA MAKES NO OTHER WARRANTIES OR REPRESENTATIONS OF ANY KIND WHATSOEVER, EXPRESSED OR IMPLIED, EXCEPT THAT OF TITLE, AND ALL IMPLIED WARRANTIES INCLUDING ANY WARRANTY OF MERCHANTABILITY AND FITNESS FOR A PARTICULAR PURPOSE ARE HEREBY DISCLAIMED. LIMITATION OF LIABILITY: The remedies of purchaser set forth herein are exclusive, and the total liability of OMEGA with respect to this order, whether based on contract, warranty, negligence, indemnification, strict liability or otherwise, shall not exceed the purchase price of the component upon which liability is based. In no event shall OMEGA be liable for consequential, incidental or special damages.

CONDITIONS: Equipment sold by OMEGA is not intended to be used, nor shall it be used: (1) as a "Basic Component" under 10 CFR 21 (NRC), used in or with any nuclear installation or activity; or (2) in medical applications or used on humans. Should any Product(s) be used in or with any nuclear installation or activity, medical application, used on humans, or misused in any way, OMEGA assumes no responsibility as set forth in our basic WARRANTY/DISCLAIMER language, and, additionally, purchaser will indemnify OMEGA and hold OMEGA harmless from any liability or damage whatsoever arising out of the use of the Product(s) in such a manner.

RETURN REQUESTS / INQUIRIES

Direct all warranty and repair requests/inquiries to the OMEGA Customer Service Department. BEFORE RETURNING ANY PRODUCT(S) TO OMEGA, PURCHASER MUST OBTAIN AN AUTHORIZED RETURN (AR) NUMBER FROM OMEGA'S CUSTOMER SERVICE DEPARTMENT (IN ORDER TO AVOID PROCESSING DELAYS). The assigned AR number should then be marked on the outside of the return package and on any correspondence.

The purchaser is responsible for shipping charges, freight, insurance and proper packaging to prevent breakage in transit.

FOR **WARRANTY** RETURNS, please have the following information available BEFORE contacting OMEGA:

1. Purchase Order number under which the product was PURCHASED,
2. Model and serial number of the product under warranty, and
3. Repair instructions and/or specific problems relative to the product.

FOR **NON-WARRANTY** REPAIRS, consult OMEGA for current repair charges. Have the following information available BEFORE contacting OMEGA:

1. Purchase Order number to cover the COST of the repair,
2. Model and serial number of the product, and
3. Repair instructions and/or specific problems relative to the product.

OMEGA's policy is to make running changes, not model changes, whenever an improvement is possible. This affords our customers the latest in technology and engineering. OMEGA is a trademark of OMEGA ENGINEERING, INC.

© Copyright 2018 OMEGA ENGINEERING, INC. All rights reserved. This document may not be copied, photocopied, reproduced, translated, or reduced to any electronic medium or machine-readable form, in whole or in part, without the prior written consent of OMEGA ENGINEERING, INC.